

**FOTRIC**

---

**Advanced Handheld Acoutherm  
Imaging Camera  
User Manual**

---

## About this manual

This manual is used as a guide and the photos, graphics, icons and illustrations provided in the manual are for explanation and illustration purposes only and may differ from the specific product, please refer to the actual product. This manual may be updated by FOTRIC without notice due to product version upgrade or other needs. The trademarks and images used in this manual are for illustrative purposes only and are the copyright of the trademark owner.

## Disclaimers

The products (hardware, software, etc.) provided in this manual may be defective, faulty or malfunctioning, and FOTRIC disclaims all warranties of any kind, express or implied, including, but not limited to, warranties of merchantability, satisfactory quality, fitness for a particular purpose, non-infringement of third party rights, etc. FOTRIC will not be liable for any special, incidental, consequential or indirect damages arising out of the use of this manual or our products. including, but not limited to, damages arising from loss of business profits, loss of data or documentation.

To the maximum extent permitted by law, our liability will not exceed the amount you paid for the product.

After the product is connected to the Internet, it may be exposed to risks including but not limited to network attacks, hacker attacks, virus infections, etc. The Company will not be responsible for any abnormal operation of the product, information leakage, etc. as a result, but will provide you with technical support in a timely manner.

Products can sense motion detection and fire events when properly installed and configured, but cannot prevent accidents or resulting personal injury or property damage.

Thermal imaging products are classified as export controlled by the U.S. Department of Commerce, Export Control Classification Number (ECCN) 6A003.b.4.b. This product contains a focal plane array, Export Control Classification Number 61002.a.3.f. This product may not be used in controlled countries (e.g. North Korea, Iran, Syria, Cuba, Sudan, etc.) and should not be brought into or used in controlled countries. Any loss or liability arising from the above actions will be borne by you.

When using this product, you are requested to strictly follow the applicable laws. You agree that this product is for civilian use only and shall not be used in violation of third party rights, medical/safety equipment or other applications where the failure of the product could result in life-threatening or personal injury, and for purposes such as mass destruction fog, biochemical weapons, nuclear explosions or any unsafe use of nuclear energy or dangerous or inhumane uses. Any loss or liability arising from such use will be borne by you.

In the event of a conflict between the above and applicable law, the provisions of the law shall prevail.

# Preface



User Manual



Analysis Software



## Symbols

 Warning	 Caution	 Note
potential death or serious injury inducing hazards.	potential danger of injury or property damage.	provides additional information to emphasize the main text.

## Safety information

The purpose of this section is to ensure that the user uses the product properly to avoid danger or property damage.

Before using this product, please read this instruction manual carefully and keep it in a safe place for future reference.



### Warning:

- Never disassemble or modify the acoutherm imaging camera battery. The battery is equipped with safety and protective devices which, if tampered with, may cause the battery to overheat and may also cause an explosion or burn. If the battery is leaking and the leak gets into your eyes, do not rub it, wash it with water and get immediate medical attention.
- acoutherm imaging cameras that use a laser pointer. Do not view the laser beam directly with the human eye. The laser beam can cause eye irritation.
- If the unit is not working properly, contact your dealer or our company and do not disassemble or modify the unit in any way (unauthorized modifications or repairs cause problems at your own risk).



### Caution:

- Protect the acoustic sensor array from stains, dust and liquids, otherwise it will affect the performance of the acoutherm imaging camera or even cause permanent damage.
- Avoid using the product in humid, dusty, extremely hot or cold environments, please refer to the product's parameter table for specific temperature and humidity requirements.
- Do not touch the sensor or lens directly to avoid staining and damage from oil and various chemicals. If

cleaning is necessary, moisten a clean cloth and gently wipe off any dust. Close the lens cap when the acoutherm imaging camera is not in use.

- When the acoutherm imaging camera is turned on, it may take approximately 5-10 minutes for the camera to warm up before taking accurate readings.
- Avoid focusing or prolonged observation on the sun or objects with extremely high temperatures, as this may result in reduced sensor life damage or temporary black spots (minor cases can be recovered after calibrating the NUC, severe cases can result in permanent irreversible damage to the detector).
- Avoid damage to the sensor caused by over-range use of the device.
- It is strongly recommended to use the original power adapter, the specific requirements of the power adapter are shown in the product data sheet.
- To prevent the potential danger of data loss, always make a copy (backup) of your data on a computer.
- When storing the acoutherm imaging camera, it is strongly recommended to use the original box and to keep it in a cool, dry, ventilated environment free from strong electromagnetic fields.
- When shipping the acoutherm imaging camera, it is strongly recommended that it be shipped protected in its factory packaging.

---

# Table of Content

<b>1</b>	<b>PRODUCT COMPONENTS .....</b>	<b>1</b>
1.	FRONT VIEW .....	1
2.	REAR VIEW .....	2
3.	SIDE VIEW .....	3
4.	TOP VIEW .....	3
<b>2</b>	<b>PREPARATION.....</b>	<b>6</b>
1.	INSERTING AND REMOVING THE BATTERY .....	6
1.1	Inserting the battery .....	6
1.2	Removing the battery.....	7
2.	CHARGING .....	7
2.1	Charging through the charging dock.....	7
2.2	Charging directly with DC 12V.....	8
3.	POWER ON AND OFF .....	9
3.1	Power On .....	9
3.2	Power Off .....	9
4.	SLEEP AND WAKE.....	10
5.	CHANGE LENSES .....	10
6.	FOCUSING .....	10
7.	CONNECTING TO EXTERNAL DEVICES AND STORAGE MEDIA.....	11
8.	INSTALL WRIST STRAP .....	11
<b>3.</b>	<b>THERMAL IMAGE DISPLAY.....</b>	<b>12</b>
1.	DROPDOWN MENU .....	12
2.	IMAGE MODE.....	13
2.1	Infrared Image Mode.....	13
2.2	T-DEF® Blend Mode.....	14
2.3	Picture-in-Picture .....	14
2.4	Digital Camera .....	15
2.5	High Sensitivity Mode .....	15
3.	PALETTES.....	16
3.1	Inverted Palette.....	16
4.	COLOR ALARM.....	17
5.	TEMPERATURE SCALE/SPAN.....	19
6.	DIGITAL ZOOM.....	21
7.	IMAGE OVERLAY INFORMATION.....	22
7.1	Global/Regional Information Display .....	22
7.2	Other Additional Information Display .....	23
8.	MAXIMUM AND MINIMUM TEMPERATURE TRACKING .....	24
8.1	Global Maximum and Minimum Temperature Tracking .....	24
8.2	Regional Maximum and Minimum Temperature Tracking .....	25
9.	HIGH TEMPERATURE DIFFERENCE EQUALIZATION IMAGING (T-TWB®).....	25

10. IMAGE DETAIL ENHANCEMENT (IREEDGE) .....	26
11. MIX MODE.....	27
<b>4.THERMAL IMAGING MEASUREMENT AND ANALYSIS .....</b>	<b>27</b>
1. TEMPERATURE MEASUREMENT RANGE.....	27
2. GLOBAL TEMPERATURE MEASUREMENT PARAMETERS.....	28
3. MEASUREMENT TOOLS (ROI).....	29
3.1 Add Spots .....	29
3.2 Add Areas .....	29
3.3 Add Lines .....	30
4. LINE TEMPERATURE DISTRIBUTION .....	30
5. REGIONAL EMISSIVITY CORRECTION (PARTIAL EMISSIVITY) .....	31
6. REGIONAL ALARM .....	32
7. TEMPERATURE RISE .....	33
8. ON-DEVICE ANALYSIS .....	34
9. ANALYSIS SOFTWARE.....	35
<b>5.THERMAL IMAGING BASIC PARAMETERS.....</b>	<b>35</b>
1. SUPER RESOLUTION (SR) .....	35
2. FOCUS MODE.....	36
2.1. Manual Focus.....	37
2.2. Auto Focus .....	37
2.3. Continuous Focus.....	38
2.4. Touch Screen Focus .....	38
3. IR DEVICE SETTINGS .....	39
<b>6.ACOUSTIC IMAGING DISPLAY.....</b>	<b>40</b>
1. SOUND SOURCE MODE .....	40
1.1. SINGLE SOUND SOURCE.....	40
1.2. MULTI SOUND SOURCE.....	41
1.3. HOLOGRAM.....	41
2. PALETTES.....	42
3. BLACK AND WHITE BACKGROUND .....	42
4. TRANSIENT MODE (T-FFTD®).....	43
5. DIGITAL ZOOM.....	43
6. IMAGE OVERLAY INFORMATION.....	44
7. SOUND PRESSURE TRACKING .....	44
<b>7.ACOUSTIC MEASUREMENT ANALYSIS .....</b>	<b>45</b>
1. FREQUENCY RANGE SELECTION .....	45
2. MEASUREMENT TOOLS .....	45
2.1 Add Spot.....	46
2.2 Add Circle .....	46
3. DETECTION MODE.....	47
4. PARTIAL DISCHARGE MODE.....	47

5.	LEAKAGE EVALUATION MODE .....	48
6.	ACOUSTIC IMAGE FOCUS .....	49
7.	ON-DEVICE ANALYSIS .....	50
8.	ANALYSIS SOFTWARE.....	51
<b>8.</b>	<b>ACOUSTIC IMAGING BASIC PARAMETERS .....</b>	<b>51</b>
1.	DISTANCE .....	51
2.	AC DEVICE SET.....	51
<b>9.</b>	<b>CAPTURE FUNCTIONS.....</b>	<b>52</b>
1.	SINGLE FRAME CAPTURE .....	52
1.1	File Naming Format.....	53
2.	TIME-LAPSE CAPTURE .....	54
3.	VIDEO RECORDING .....	55
3.1	Radiometric Video Recording.....	56
3.2	Holographic video recording.....	57
3.3	MP4 Video Recording.....	57
3.4	Video Format.....	58
4.	FREEZE INTERFACE .....	59
5.	QR CODE SCAN .....	60
6.	VOICE ANNOTATION.....	61
7.	TEXT ANNOTATION .....	62
8.	TAG TABLE.....	63
9.	FAVORITES .....	65
10.	SKETCH .....	66
11.	GALLERY.....	66
12.	ON-DEVICE REPORT.....	69
<b>10.</b>	<b>PLUG-INS.....</b>	<b>70</b>
1.	MAGICTHERMAL®.....	70
2.	NAVIPDM VENUS .....	71
<b>11.</b>	<b>CONNECTION .....</b>	<b>71</b>
1.	WiFi CONNECTION.....	71
2.	BLUETOOTH .....	72
3.	USB INTERFACE .....	72
4.	HDMI INTERFACE .....	74
5.	FTP.....	74
6.	PC RADIOMETRIC VIDEO STREAM.....	75
7.	REMOTE DISPLAY .....	75
<b>12.</b>	<b>REMOTE CONTROL.....</b>	<b>75</b>
1.	PC CONTROL.....	76
2.	MOBILE DEVICE CONTROL .....	76
3.	WEBPAGE CONTROL .....	76

---

<b>13.AUXILIARY FUNCTIONS .....</b>	<b>76</b>
1. INTELLIGENT FOCUSING SYSTEM (TURBOFOCUS®) .....	76
2. FLOATING BALL.....	79
3. LASER .....	79
4. REGION FEATURE MEASUREMENT .....	80
5. GPS .....	81
6. COMPASS .....	82
7. LED LAMP.....	82
8. LANGUAGE.....	83
9. SOFTWARE AND FIRMWARE UPGRADES .....	84
10. DEVICE SET .....	87
<b>APPENDIX A.EMISSION TABLE .....</b>	<b>93</b>

---

# 1 Product Components

## 1. Front View

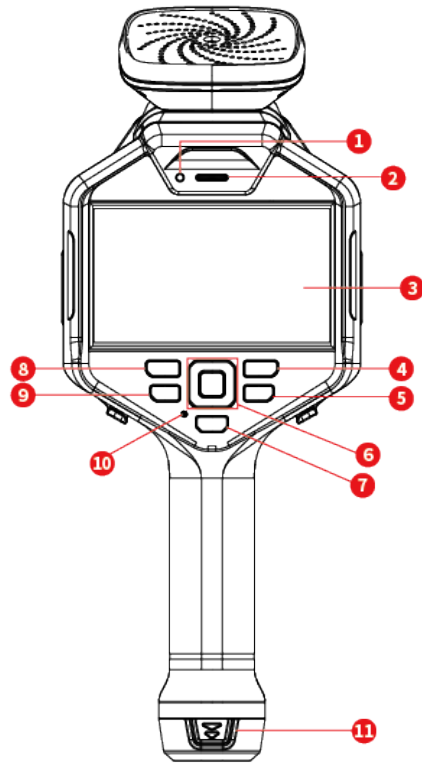

---

## 2. Rear View

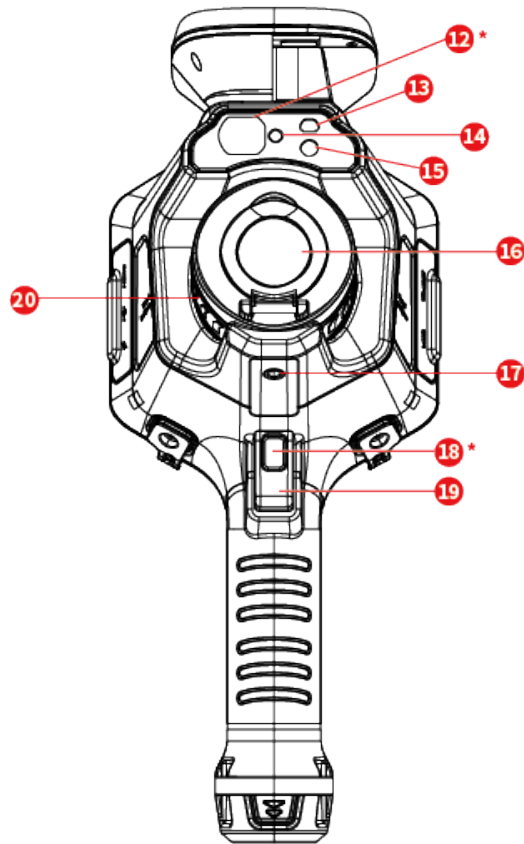

### 3. Side View

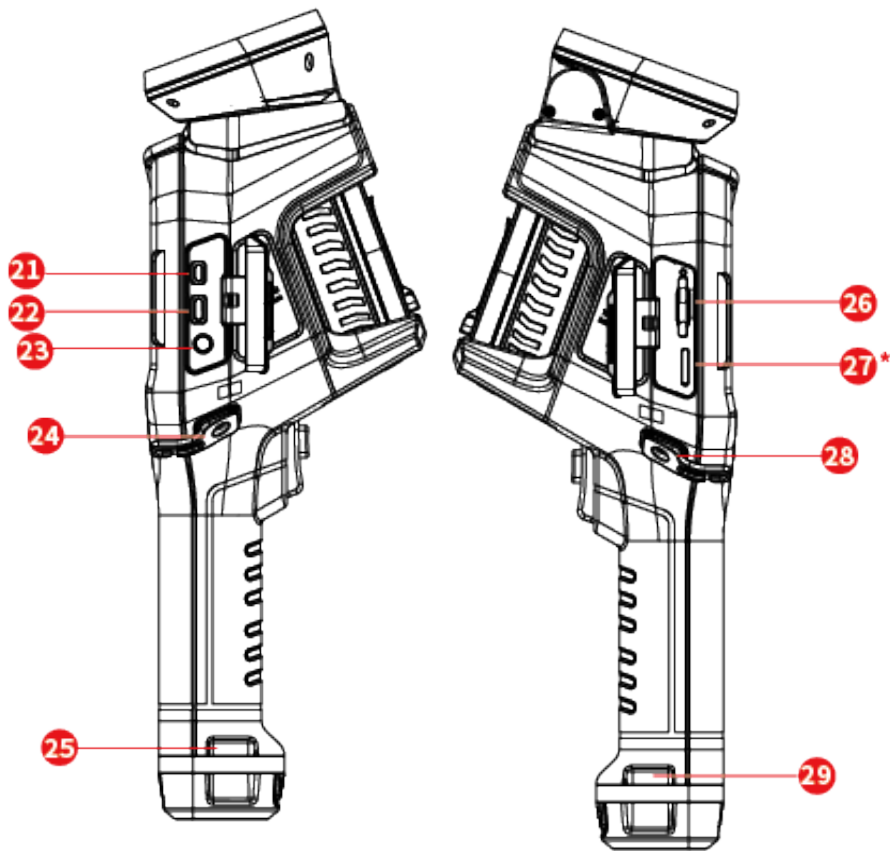

### 4. Top View

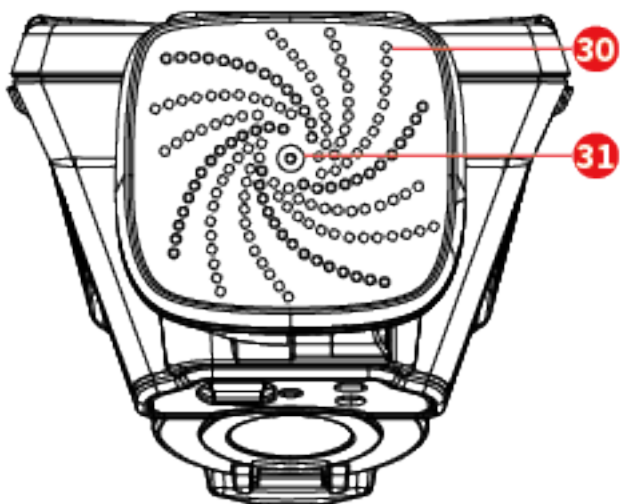

The appearance of different models of the product may vary. Please refer to the

---

actual product.

## Parts and interfaces

	Name	Function
1	Indicator LED	<ul style="list-style-type: none"><li>● Green, blinking: charging</li><li>● Green, glowing: fully charged, screen off</li></ul>
2	Speaker	Play voice, alarm
3	Touch Screen	<ul style="list-style-type: none"><li>● Display</li><li>● Touch screen operation</li></ul>
4	Gallery Button	<ul style="list-style-type: none"><li>● Enter gallery</li><li>● Activate NUC(Non-Uniform Calibration)</li></ul>
5	Back Button	Exit menu or back to the previous menu
6	Navigation Buttons	Menu mode <ul style="list-style-type: none"><li>● Press▲, ▼, ◀, ▶to select parameters</li><li>● Press confirmation key to confirm</li></ul>
		Non-menu mode Press confirmation key to summon the menu
7	AI Programmable Button	<ul style="list-style-type: none"><li>● Short press: activate custom functions</li><li>● Long press: select custom functions</li></ul>
8	Power Button	<ul style="list-style-type: none"><li>● Short press: power on/off device</li><li>● Long press: sleep/wake screen</li></ul>
9	Laser Button	<ul style="list-style-type: none"><li>● Press to activate laser</li><li>● Release to deactivate laser</li></ul>
10	Microphone	Input voice information
11	Battery	Lithium battery, for power supply

12*	Laser Ranger(optional)	For laser ranging
13	Laser Emitter	For laser indications
14	LED Flash Light	<ul style="list-style-type: none"> <li>● Flash light : serve as a flash light when taking photos</li> <li>● For illumination in dark environment</li> </ul>
15	Digital Camera	Digital visible-light camera
16	Infrared Lens	For infrared imaging
17	Tripod Connection Interface	For mounting on a tripod
18*	Autofocus Button(optional)	Press to conduct autofocus
19	Freeze and Capture Button	Freeze and capture images/videos
20	Focus Ring	Rotate to adjust the clarity of images
21	Micro HDMI Interface	High resolution streaming interface, compatible to projecting to a HDMI screen
22	USB Type-C Interface	For connecting to a USB Type-C cable
23	Power Supply Interface	For connecting to DC power adaptor
24 & 25	Wrist Strap Bracket	For fixing the wrist strap(right)
26	SD Storage Card Interface	For inserting the SD card
27*	Nano SIM Port (optional)	For inserting Nano SIM card

---

28 & 29	Wrist Strap Bracket	For fixing the wrist strap(left)
30	Acoustic Module	Microphone array
31	Digital Camera	Digital visible-light camera

## **2 Preparation**

### **1.Inserting and Removing the Battery**

#### **1.1 Inserting the battery**

Push the battery into the battery socket. When the battery is fully inserted, it will make a distinct 'click'.

---

## 1.2 Removing the battery

Turn off the device, squeeze the snatch of the battery and take it out.

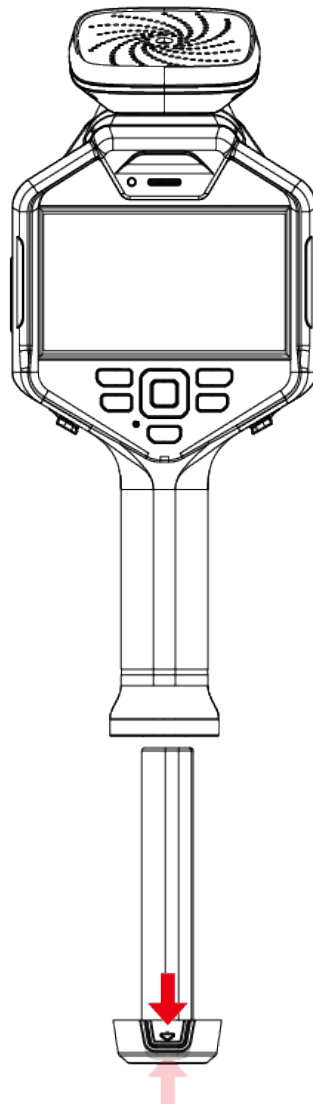

## 2. Charging

When using the thermal imager for the first time or when the power is low, please charge the thermal imager.

### 2.1 Charging through the charging dock

For quick charging take out the battery and mount it on the charging dock.

The voltage of the charging dock is 12VDC, please use the USB-C cable and the adaptor that came with the device.

#### Operation Procedures

1. Mount the battery(s) to the charging dock.
2. Connect the charging dock to the power source. If the dock is functioning normally, the middle LED indicators will glow green.
3. The LED indicators on the side indicate the charging status of the battery:

- 
- Red: charging
  - Green: charged

4. When fully charged, take out the battery and disconnect the dock from the power source.

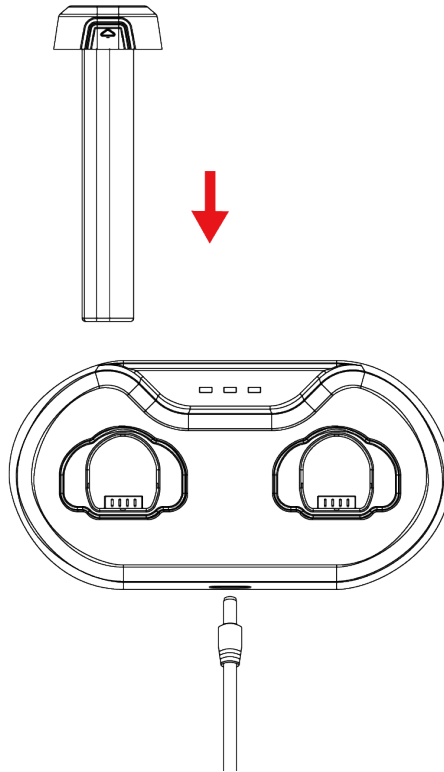

## 2.2 Charging directly with DC 12V

For expedient charging, directly charge the thermal imager through a DC 12V power adapter.

### Operation Procedures

1. Insert the battery
2. Lift the cover for USB-C interface
3. Connect to a power source and start charging

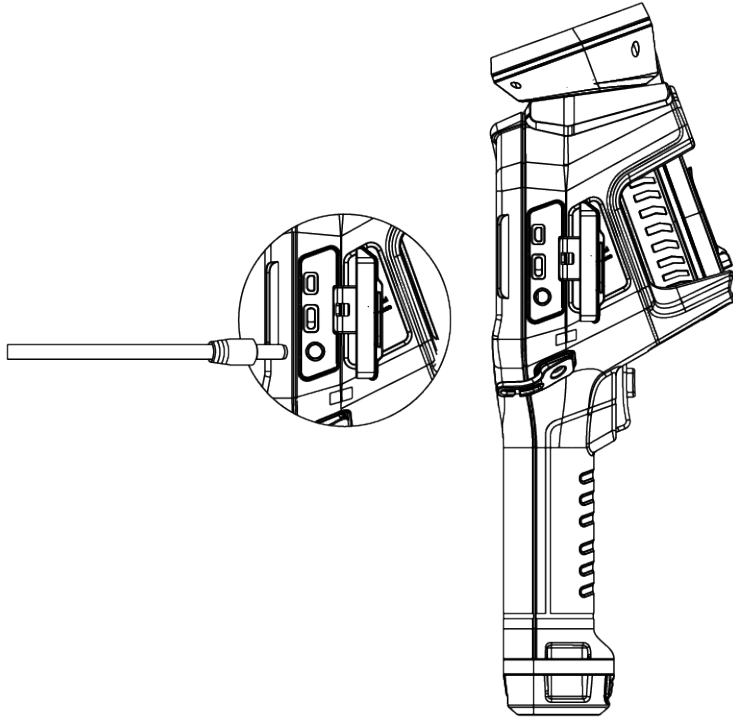

### 3. Power On and Off

#### 3.1 Power On

When sufficient battery power is available, press and hold the Power button to turn on. Once powered on, enters the real-time observation interface.



*Note:*

If battery power is low, charge or replace the battery promptly to avoid affecting usage.

#### 3.2 Power Off

Turn off manually or set an automatic shutdown time.

##### **Manual Shutdown**

Press and hold the Power button to turn off.

##### **Automatic Shutdown**

Set the automatic shutdown time. If no touch screen operation, no button press, and no USB connection, automatically shuts down after the set time is reached.

---

## 4. Sleep and Wake

Put into sleep mode manually to save power and extend battery life.

Press the Power button briefly to put into sleep mode or wake up.

## 5. Change Lenses

### Operation Procedures:

1. Rotate counterclockwise to unmount the lens.
2. Carefully take off the lens
3. Align the red dot mark on the lens and the lens slot.
4. Gently push the lens in until it's firmly mounted.
5. Rotate clockwise until hearing a distinct 'click'.



### Caution

If you have purchased a new lens, please contact your dealer or the nearest service center to calibrate the new lens. This ensures optimal performance and compatibility between the lens and the device.

Before turning on the camera, make sure the lens is in place and locked securely. If it is not in place, the camera will not be able to recognize the lens when it is turned on.

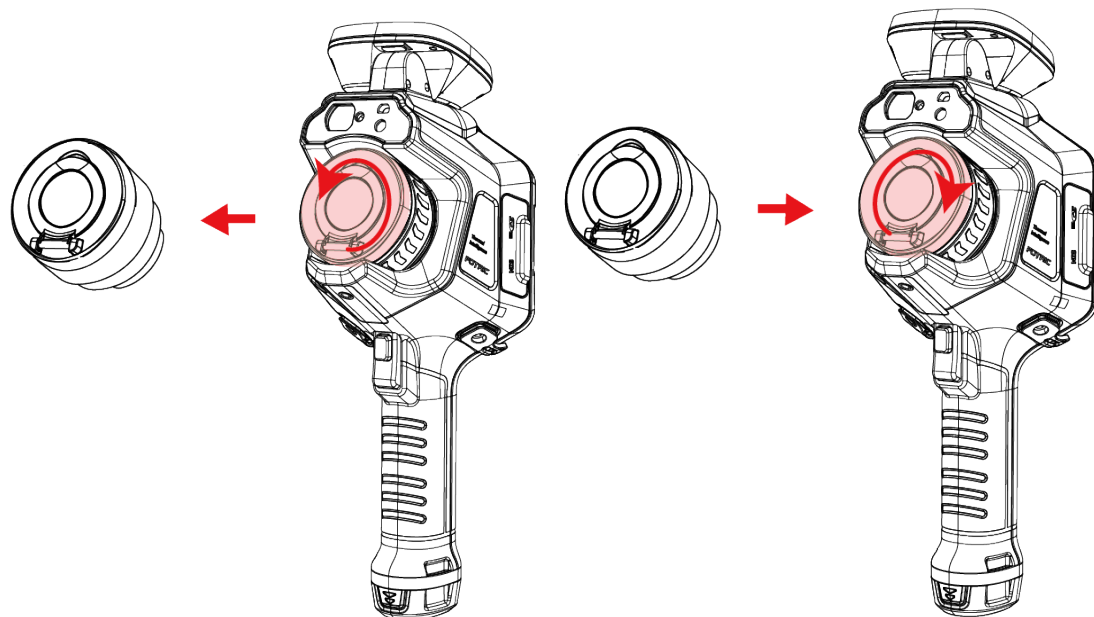

## 6. Focusing

Adjust the focus manually or automatically to make the captured scene image clear.

---

### **Manual Focus**

Point the lens at the scene to be observed, then rotate the focus wheel next to the lens clockwise or counterclockwise to adjust the focus.

### **Auto Focus**

Press the auto-focus button to automatically adjust the focus.



This feature is supported on some models only; please refer to the actual device.

## **7. Connecting to External Devices and Storage Media**

### **External Devices**

Use a compatible HDMI cable to connect one end to the device's Micro HDMI interface and the other end to a display. The image will be projected onto the connected screen.

### **Storage Media**

The device is equipped with a storage card to store captured inspection data, reports, and other files.



The included storage card may vary; please refer to the actual device.

## **8. Install Wrist Strap**

Inserting the strap through the Wrist Strap Bracket and make adjustments  
(Refer to the item 24 & 25, 27 & 28 of **Parts and interfaces** table)

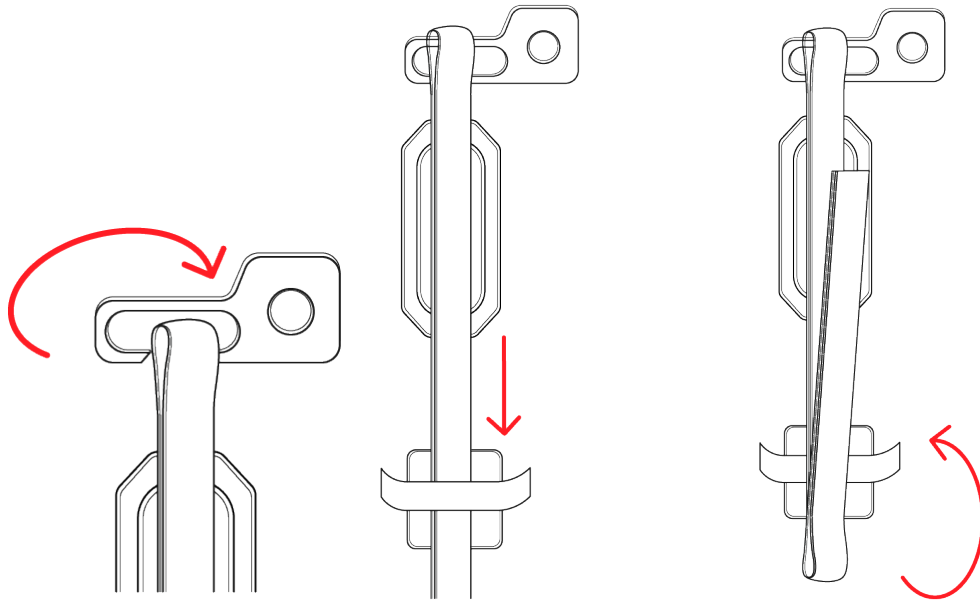

### 3. Thermal Image Display

Users can swipe down from the top of the screen to bring up the system's drop-down menu. In this menu, users can toggle functions on or off or adjust settings through touch operations. When a function is turned on, its corresponding option will be highlighted. Users can quickly exit the drop-down menu by swiping up from the bottom of the screen.

#### 1. Dropdown Menu

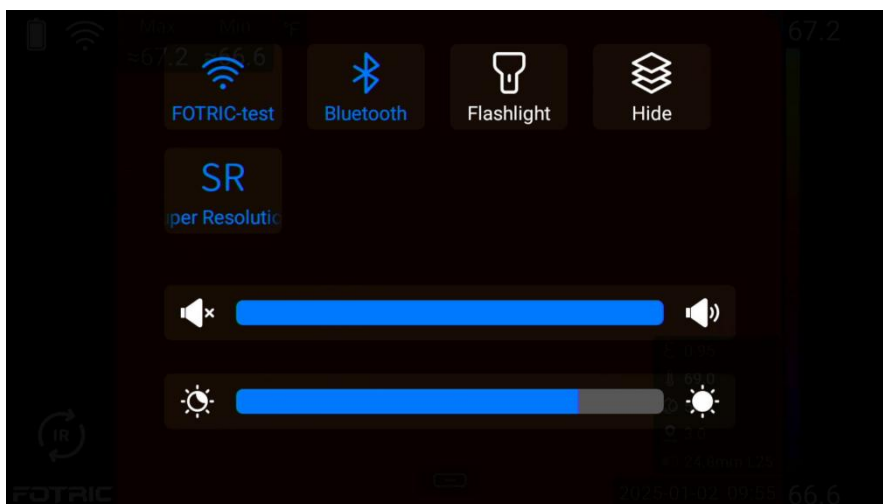



The interface displays different function switches depending on the specific model. Please refer to the actual device for details.

## 2. Image Mode

The device captures infrared and visible light images. Users can select different image modes to meet various image display needs. The specific steps are as follows:

1. **Live Interface:** When the device is in IR mode, press the OK button or tap the main menu to bring up the device menu.
2. **Device Menu → Image Mode**
3. Select the desired image mode

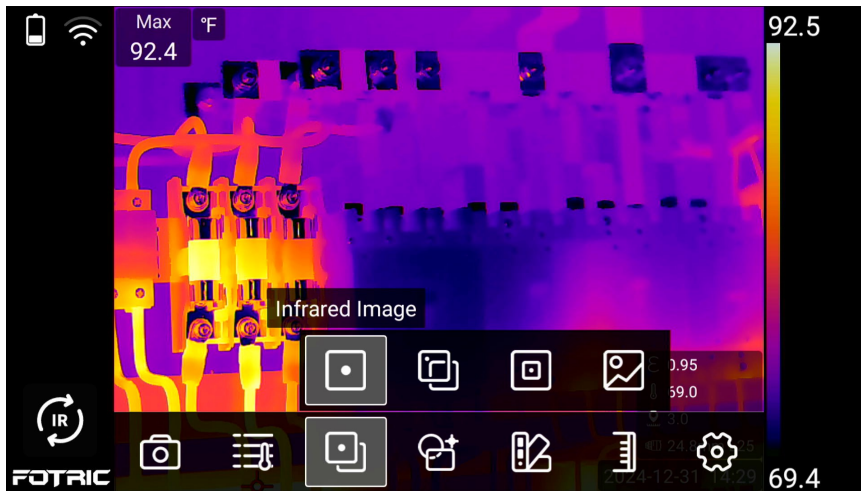

### 2.1 Infrared Image Mode



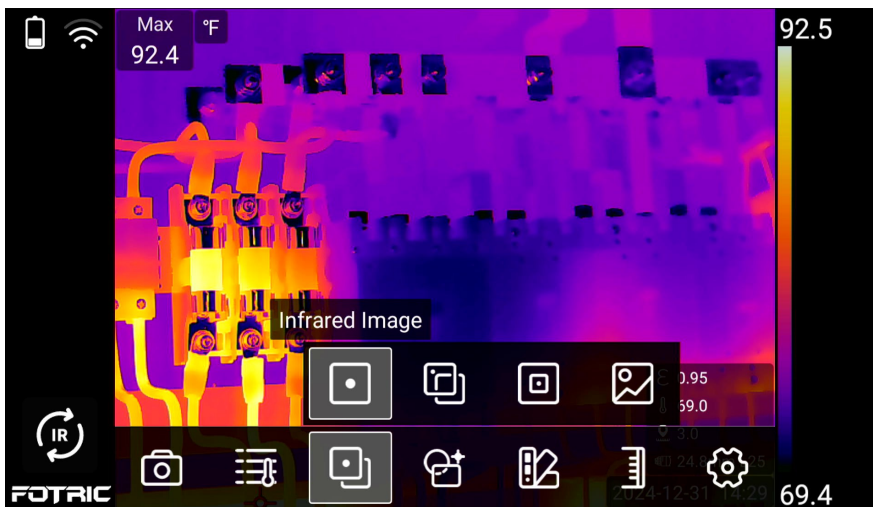

This mode displays infrared images.



---

## 2.2 T-DEF® Blend Mode

This mode allows users to view both thermal and visible light real-time images simultaneously. Users can adjust the infrared image transparency from 0% to 100% by tapping the transparency

slider “” or using the left “” and right “” arrow keys. Additionally, users can press the OK button “” or the Back button “” to hide the adjustment slider.

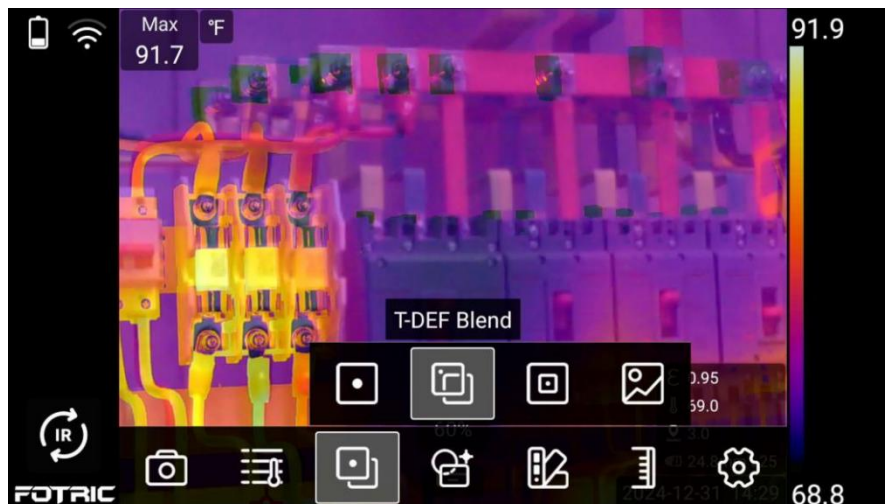

## 2.3 Picture-in-Picture

The mode overlays an adjustable infrared image on a visible light image, where the infrared image can be moved and resized. The user can select the center area of the infrared image by tapping the screen.

Once selected, the user can drag the center of the infrared image or use the arrow keys to move

the image position. Pressing the OK button “” switches to the size adjustment mode, where the user can drag the corners of the infrared image on the touchscreen or use the arrow keys to

adjust its size. Pressing the back button “” exits the position or size editing mode for the infrared image.

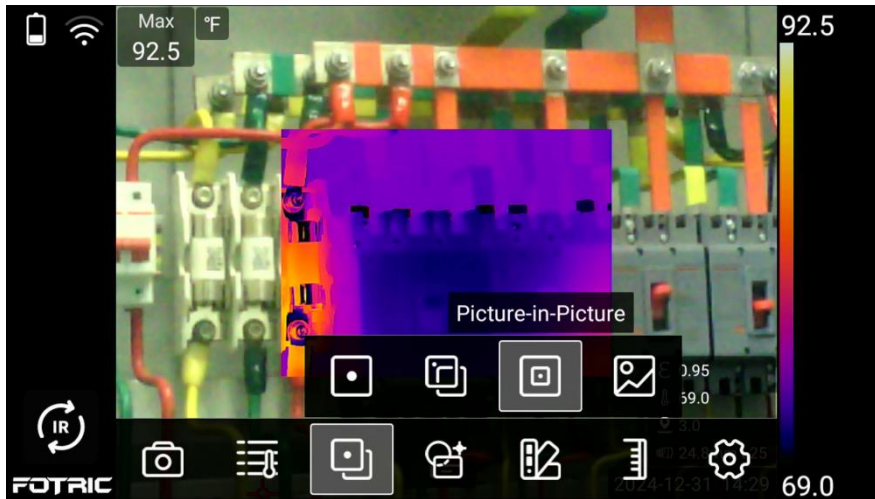

## 2.4 Digital Camera

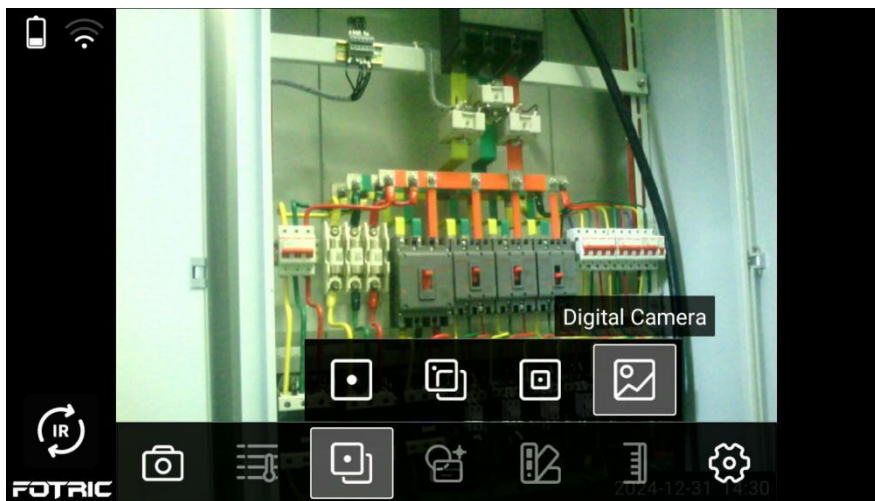

This mode displays visible light images captured by the digital camera.

## 2.5 High Sensitivity Mode

This mode is specifically designed for gas detection applications, using frame-difference technique to make leaks more clearly visible in the image.



**Note**

1. The different image modes on the device vary depending on the specific model. Please refer to the actual device for details.
2. To use/disable visible light, enable/disable it through: **Settings** → **Storage and Save Options** → **Digital Camera Options**.

---

### 3. Palettes

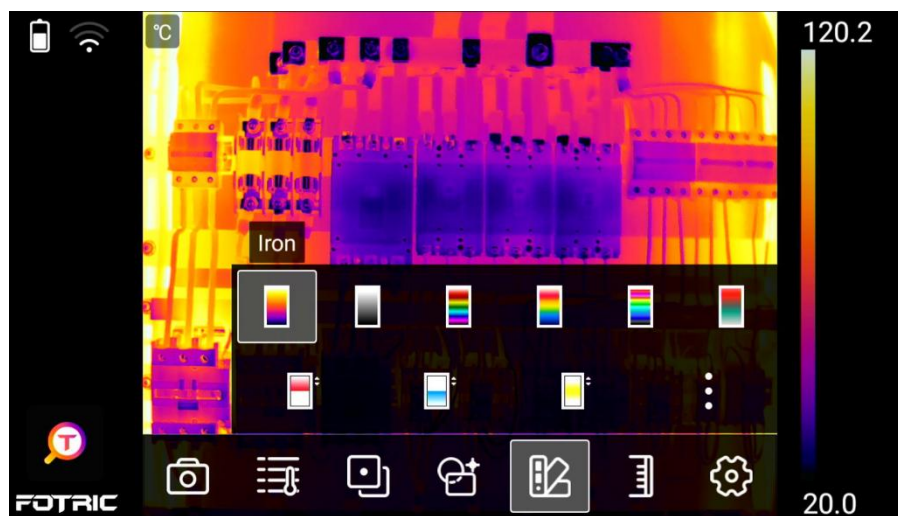

The device allows you to change the color palette to display different image colors, making images in various scenes clearer. The specific steps are as follows:

1. **Live Interface:** Press the OK button or tap the main menu to bring up the device menu->**Palettes**
2. Select the desired color palette, or go to **Device Menu** → **Palettes** → **More** , and then choose from more options.



#### 3.1 Inverted Palette

The device allows you to invert the color palette to swap the colors corresponding to high and low temperatures, improving the image effect. The specific steps are as follows:

1. **Live Interface:** Press the OK button or tap the main menu to bring up the device menu
2. **Device Menu** → **Palettes** → **More** 
3. Tap **Invert Palettes** .

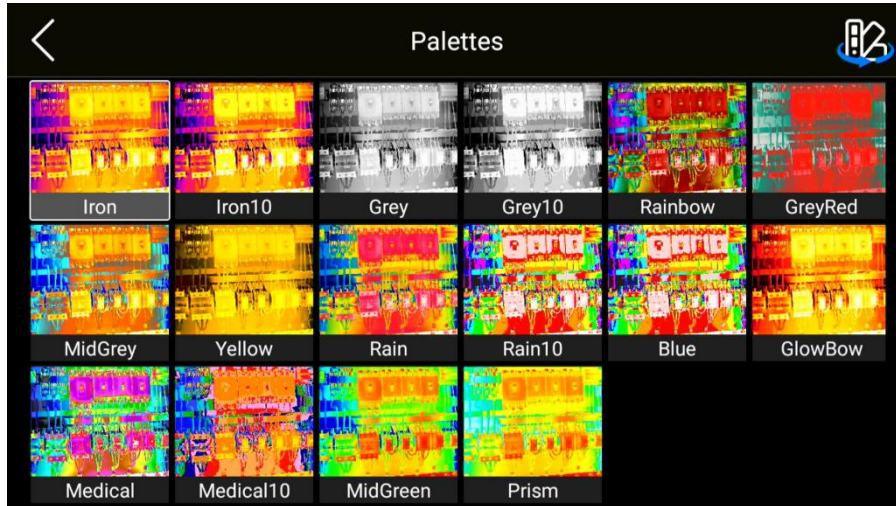

 **Note**

1. The different **palettes/inverted palettes** on the device vary depending on the specific model. Please refer to the actual device for details.
2. Before using the inverted color palette, enable: **Settings** → **IR Device Set** → **Measurement Enhancement** → **Palette Extension**



## 4. Color Alarm

The device supports alarms for Above Temperature Alarm, Below Temperature Alarm , Between Temperature Alarm, Humidity, and Insulation Color. This means the user can set alarm thresholds, and when the measured temperature or object meets the alarm conditions, the device will display an alarm color to help identify anomaly in the monitoring scenario. The specific operation steps are as follows:

In the main menu interface, press the OK button or touch the main menu to bring up the device menu.

- 
1. Device menu → Palette.
  2. Select the alarm color type, set the alarm thresholds, and then check for any abnormal situations.

**Above Temperature Alarm:** Display all pixels with a temperature higher than the alarm threshold in the alarm color.



**Below Temperature Alarm:** Display all pixels with a temperature lower than the alarm threshold in the alarm color.

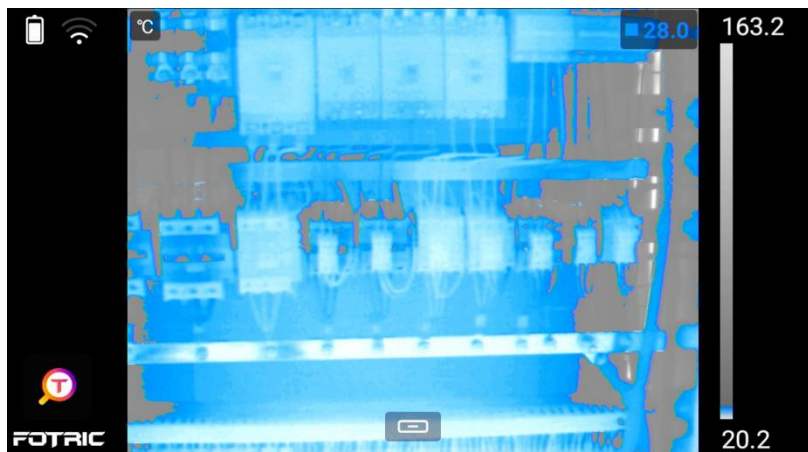

**Between Temperature Alarm:** Display all pixels with a temperature within the alarm threshold range in the alarm color.

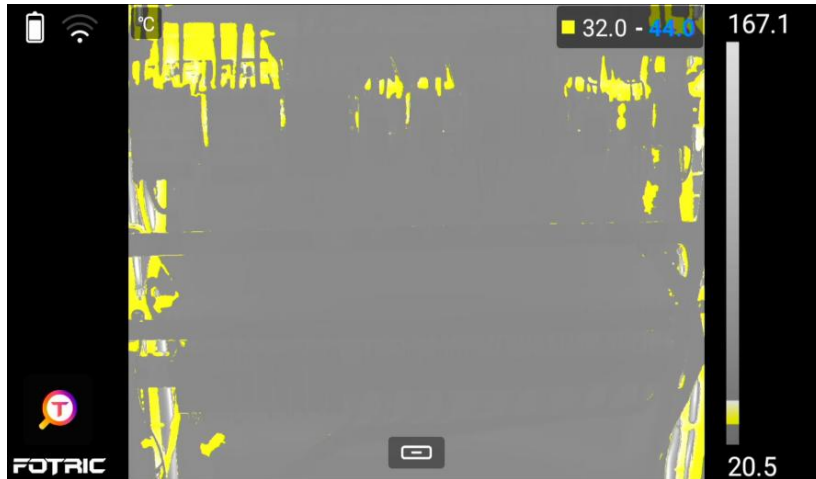

**Note**

- 1.The color alarm on the device depends on the specific model. Please refer to the actual device for details.
- 2.Before using the color alarm, you need to enable it by going to: **Settings** → **IR Device Set** → **Measurement Enhancement**→ **Palette Extension**.

## 5. Temperature Scale/span

The device temperature span adjustment supports **automatic, manual, and touch modes**. The specific operation steps are as follows::

- 1.In the main menu interface, press the OK button or touch the main menu to bring up the device menu.
2. Device menu → Temperature Scale Mode.
3. Select the Temperature Scale Mode.

**Auto Span:** Adjust the upper and lower limits based on the global highest and lowest temperatures of the image.

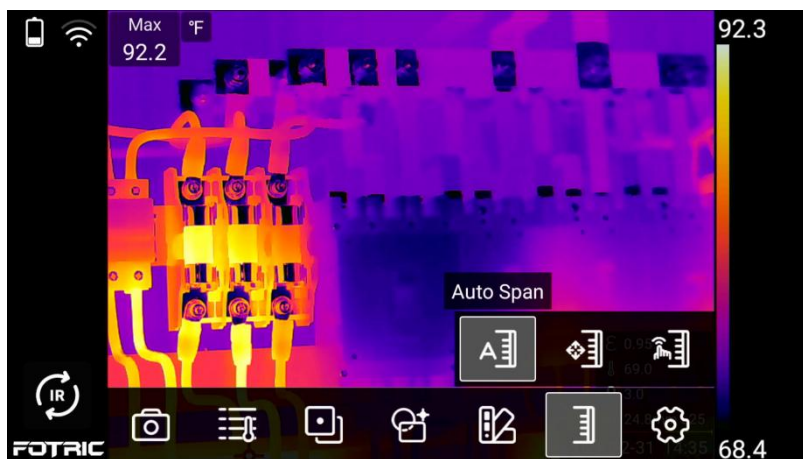

**Manual Span:** Adjust the upper and lower limits to be close to the temperature of the specific target in the image.

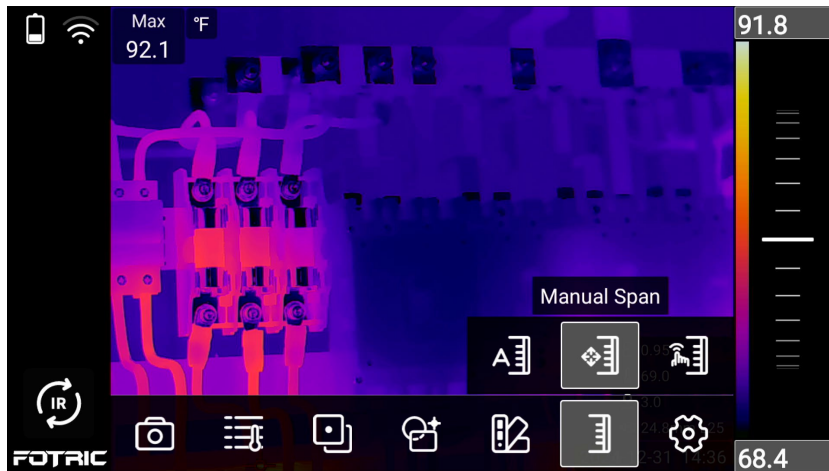

**Touch Span:** Adjust the upper and lower limits by tapping on the thermal image area.

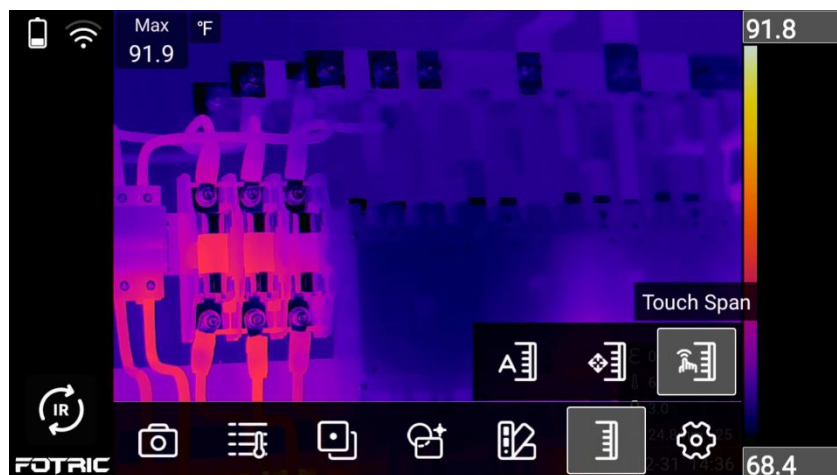

Select Manual Temperature Range mode to set different adjustment modes: **Device menu → Settings → IR Device Set → Manual Temperature Range Adjustment Mode.**

**Max/Min:** The upper and lower limits can be adjusted individually or simultaneously to modify the image display effect. In manual temperature range mode, the values can be adjusted by scrolling the wheel or pressing the up/down buttons. Alternatively, by clicking on the upper and lower limits or using the left/right keys, the user can switch between single or simultaneous adjustments of the values.

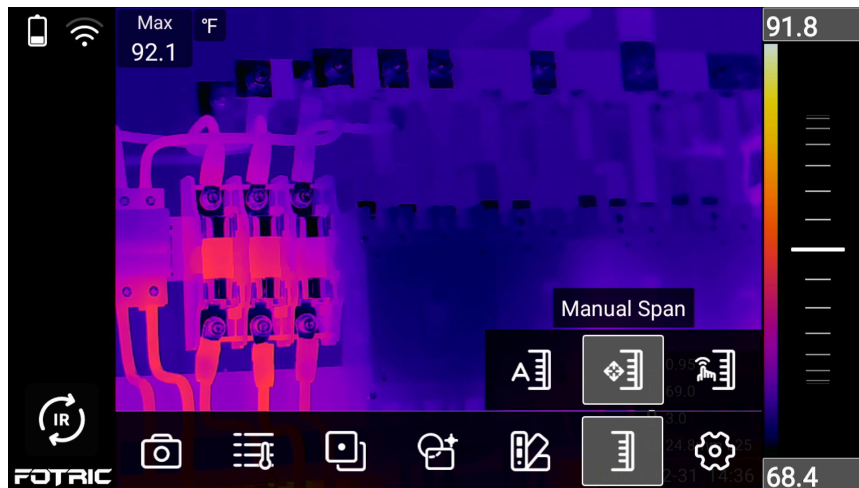

**Temperature Span:** The difference between the upper and lower limits can be adjusted to modify the image display effect. The upper and lower limits can be adjusted simultaneously by scrolling the wheel or pressing the up/down buttons. Alternatively, the temperature range width can be adjusted by pressing the left/right keys, with simultaneous adjustment of the upper and lower limits to match the change in temperature range width.

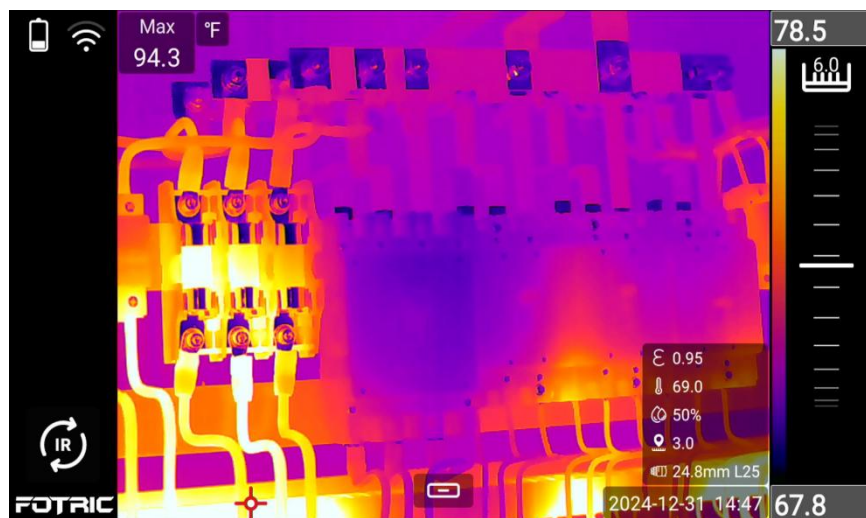

The Temperature Span Mode on the device depends on the specific model. Please refer to the actual device.

## 6. Digital Zoom

The digital zoom function of the device allows for controlling the scaling and display of images. The specific operation steps are as follows:

1. **Zoom In:** Tap the screen with two fingers and spread them outward.

2. **Zoom Out:** Tap the screen with two fingers and pinch them together.
3. When the zoom level exceeds 1x, a **zoom slider wheel** will appear. The user can adjust the zoom level by sliding the wheel on the touch screen or using the left and right direction keys. Press the OK button or the Back button to hide the slider wheel. Alternatively, the user can tap the zoom value again to bring up the zoom slider wheel.



### Note

The digital zoom functionality of the device depends on the specific model. Please refer to the actual device for details.

## 7. Image Overlay Information

### 7.1 Global/Regional Information Display

This setting is used to specify the overlay display of global maximum temperature, minimum temperature, regional maximum temperature, minimum temperature, average temperature, and emissivity on the image. The specific operation steps are as follows:

1. In the main menu interface, press the OK button or tap the main menu to bring up the device menu.
2. Device menu → ROI → Display Settings

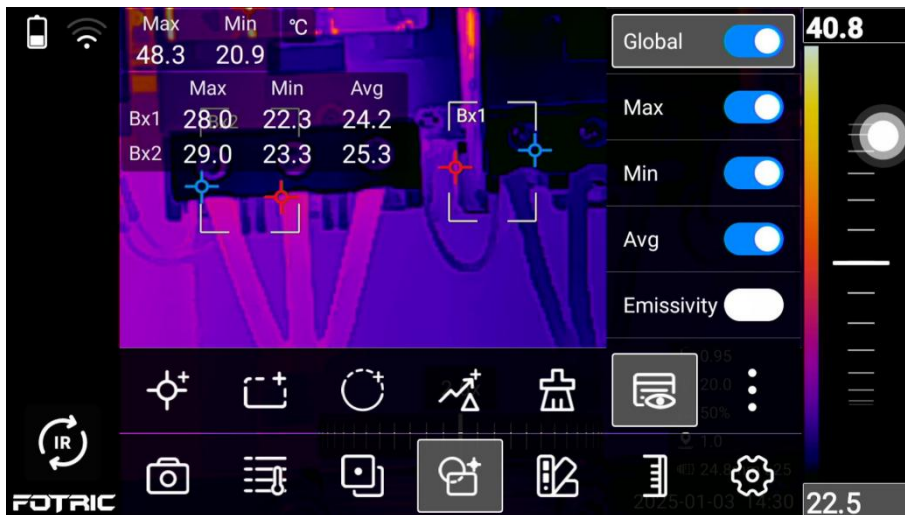

3. Enable the overlay for the maximum temperature, minimum temperature, average temperature, and emissivity. The global information will be displayed based on whether the global option and the maximum/minimum temperature options are enabled.

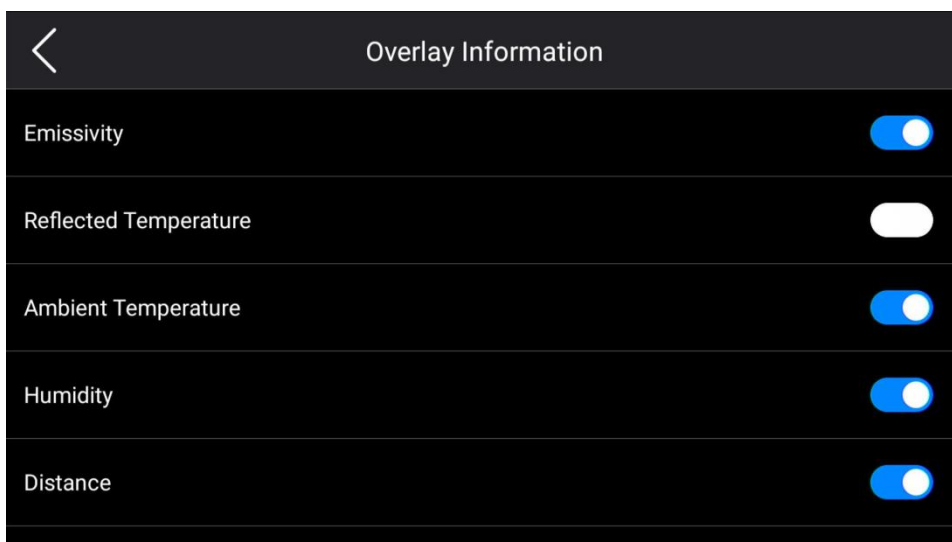

## 7.2 Other Additional Information Displayed

This setting is used to specify the temperature measurement parameters, lens, compass information, as well as the date and time information displayed as an overlay on the image. The specific operation steps are as follows:

1. In the main menu interface, press the OK button/tap the main menu to bring up the device menu.
2. **Device menu → Settings → IR Images → Overlay Information**

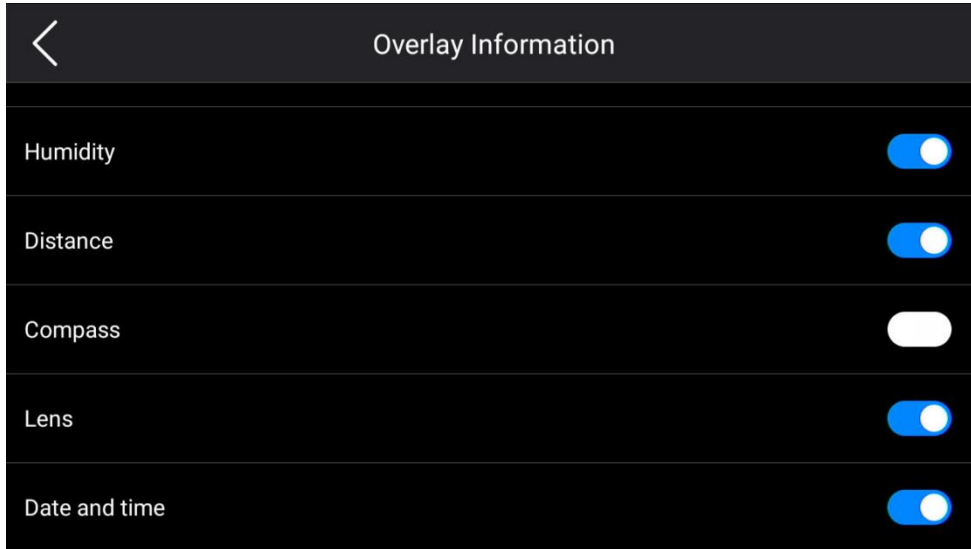

3.Enable the content to be overlaid

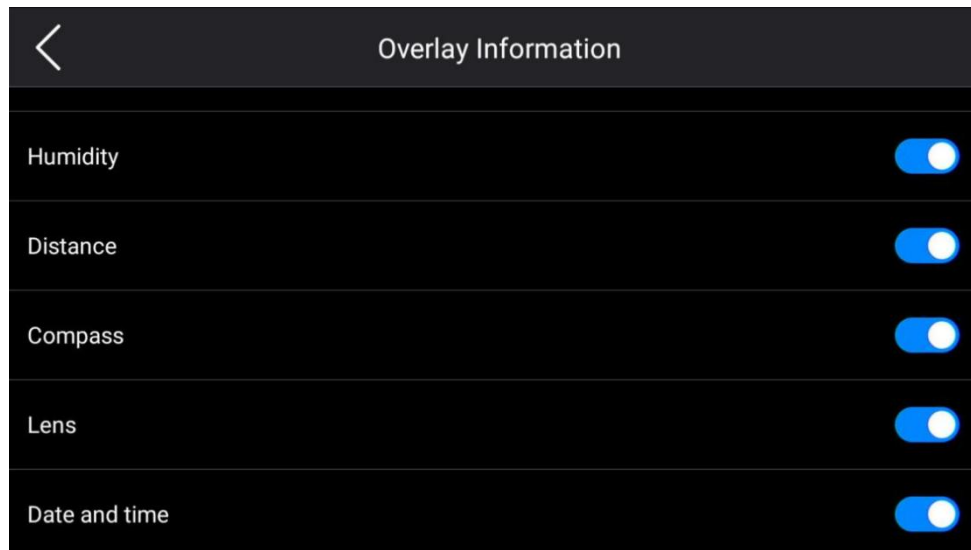

**Note**

The overlay information options on the device vary depending on the specific model. Please refer to the actual device.

## 8. Maximum and Minimum Temperature Tracking

The device can automatically track the position of the maximum and minimum temperature points globally or within a specific area using special markers.

### 8.1 Global Maximum and Minimum Temperature Tracking

When the global highest and lowest temperatures are overlaid on the image, the position of the global highest temperature point is marked in red, and the position of the global lowest temperature point is marked in blue.



## 8.2 Regional Maximum and Minimum Temperature Tracking

When the highest and lowest temperatures of the region are overlaid on the image, the position of the region's highest temperature point is marked in red, and the position of the area's lowest temperature point is marked in blue.

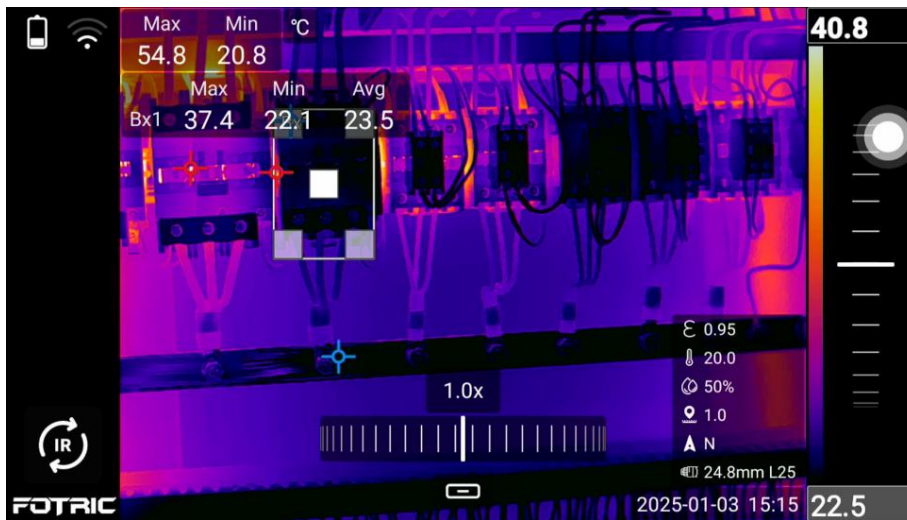

## 9. High Temperature Difference Equalization Imaging (T-TWB®)

This function optimizes the display of images with a wide dynamic range, effectively shielding interference from high-temperature heat sources and clearly showing the thermal gradient changes of the measured object. The specific operation steps are as follows:

- ✧ In the main menu interface, press the OK button/tap the main menu to bring up the device menu.
- ✧ **Device menu → Settings → IR Device Set → Measurement Enhancement → Image Enhancement.**

- ✧ Select the image mode with infrared imaging, press the OK button or click the mode again to bring up the menu.
- ✧ Enable T-TWB® function.

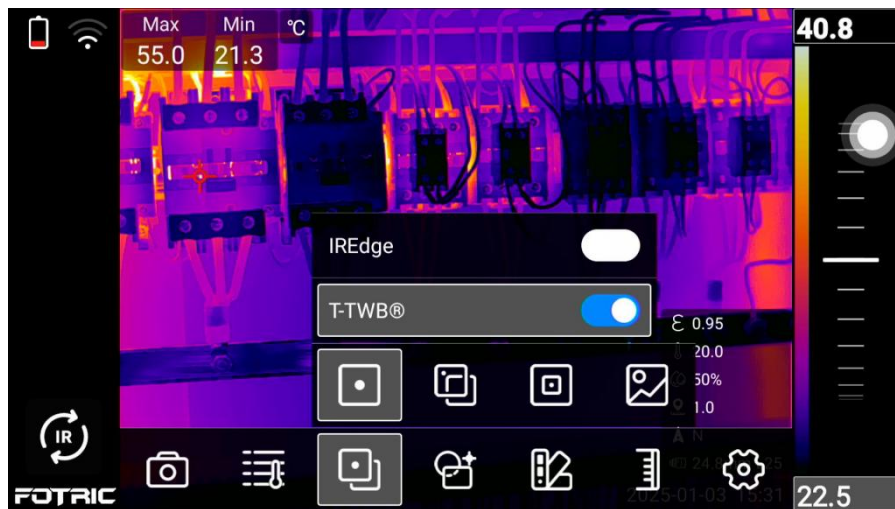

Whether the device supports this function depends on the specific model. Please refer to the actual device.

## 10. Image Detail Enhancement (IREdge)

This function supports IREdge infrared image contour enhancement, which allows for the recognition and sharpening of the measured object's infrared contours. It can significantly enhance the imaging details of target objects in complex scenes. The specific operation steps are as follows:



In the main menu interface, press the OK button or tap the main menu to bring up the device menu

- ✧ **Device menu → Settings → IR Device Set → Measurement Enhancement → Image Enhancement**
- ✧ **Device menu → Image Mode**
- ✧ Select the image mode with **infrared image**, press the OK button or click the mode again to bring up the menu.
- ✧ Enable the image detail enhancement function.



## 11. MiX Mode

This function is a new diagnostic method introduced based on the actual field conditions, where the thermal distribution and acoustic signature information of the measured object are displayed simultaneously. It allows for fault characteristics of the measured object to be obtained from multiple dimensions, enabling a more comprehensive fault analysis. The specific operation steps are as follows:

In Main menu interface,  →  → 



## 4. Thermal Imaging Measurement and Analysis

### 1. Temperature Measurement Range

The device supports different temperature ranges. To obtain accurate temperature measurements, the user needs to change the device's temperature measurement range to match the expected temperature of the measured object. The specific operation steps are as follows:

- ✧ In the main menu interface, press the OK button or tap the main menu to bring up the

device menu.

- ✧ **Device menu → Settings → Temperature Measurement Range**
- ✧ Select the appropriate temperature measurement range.

### **Note**

The temperature measurement range of the device varies depending on the product model. Please refer to the actual device for the specific model.

## 2. Global Temperature Measurement Parameters

To ensure accurate temperature measurements for different measured targets, please make sure to set the correct temperature measurement parameters. The specific operation steps are as follows:

- ✧ In the main menu interface, press the OK button or tap the main menu to bring up the device menu.
- ✧ **Device menu → Parameters → Emissivity**, change the corresponding parameter based on the measured object. The user can refer to Appendix A: Emissivity Table
- ✧ **Device menu → Parameters → Reflected Temperature**. When there is a high-temperature target in the scene, if the measured object has a low emissivity and reflects the high-temperature target, the reflected temperature should be set to the temperature value of the high-temperature target.
- ✧ **Device menu → Parameters → Ambient Temperature**, change the corresponding parameter based on the current observation environment.
- ✧ **Device menu → Parameters → Relative Humidity**, adjust the corresponding parameter based on the current observation environment.
- ✧ **Device menu → Parameters → Target Distance**, adjust the corresponding parameter based on the distance between the measured object and the device.
- ✧ **Device Menu → Parameters → IR Window Compensation**, change the corresponding parameters, and set the on/off status, as well as temperature and transmittance.

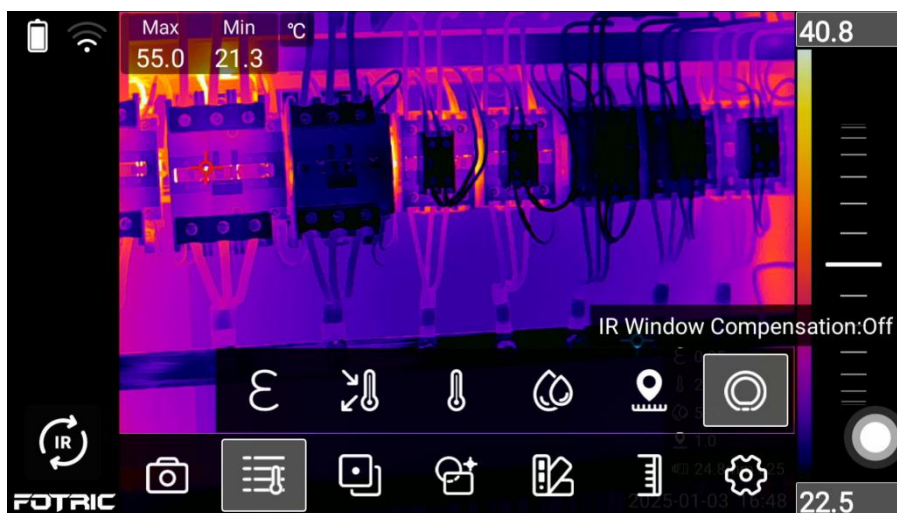

---

### 3. Measurement Tools (ROI)

The device can perform temperature measurement on points, lines, or areas by setting specific locations, boundaries, or regions of interest.

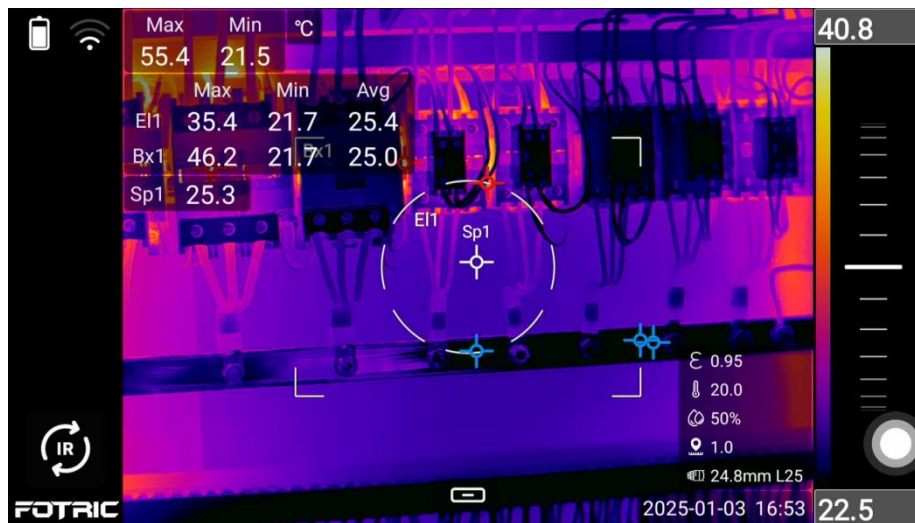

The specific operation steps are as follows:

- ✧ On the main menu interface, press the OK button or touch the main menu to bring up the device menu.
- ✧ In the device menu, go to **ROI** → select temperature measurement tool
- ✧ Touch and select the temperature measurement tool, then drag or use the arrow keys to move and adjust the position of the measurement tool.

#### 3.1 Add Spots

The specific operation steps are as follows:

- ✧ On the main menu interface, press the OK button or touch the main menu to bring up the device menu.
- ✧ In the device menu, go to **ROI** → select **Add Spot**
- ✧ Touch the center area of the measurement tool, then drag or use the arrow keys to move and adjust the position of the measurement tool.
- ✧ Touch any of the four corner points of the measurement tool, then drag or use the arrow keys to adjust the size of the measurement tool.

#### 3.2 Add Areas

The specific operation steps are as follows:

- 
- ✧ On the main menu interface, press the OK button or touch the main menu to bring up the device menu.
  - ✧ In the device menu, go to **ROI → select Add Rectangle/Circle**
  - ✧ Touch the center area of the measurement tool, then drag or use the arrow keys to move and adjust the position of the measurement tool.
  - ✧ Touch any of the four corner points of the measurement tool, then drag or use the arrow keys to adjust the size of the measurement tool.

### 3.3 Add Lines

The specific operation steps are as follows:

- ✧ On the main menu interface, press the OK button or touch the main menu to bring up the device menu.
- ✧ In the device menu, go to **ROI → More → Add Line.**
- ✧ Touch the center area of the measurement line, then drag or use the arrow keys to move and adjust the position of the measurement line.
- ✧ Touch either of the two end points of the measurement line, then drag or use the arrow keys to adjust the size of the measurement line.



The temperature measurement spot, line, and frame functions on the device may vary depending on the specific model. Please refer to the actual device for details

If the device supports temperature measurement lines, you need to enable the feature before using the measurement line:

**Settings → IR Device Set → Measurement Enhancement → Measurement Tool Extension**

## 4. Line Temperature Distribution

The device supports drawing the temperature distribution curve for the temperature measurement line. The specific operation steps are as follows:

- ✧ On the main menu interface, press the OK button or touch the main menu to bring up the device menu.
- ✧ In the device menu, go to **Settings → IR Device Set → Line Temperature Distribution.**
- ✧ Enable/disable the line temperature distribution function.

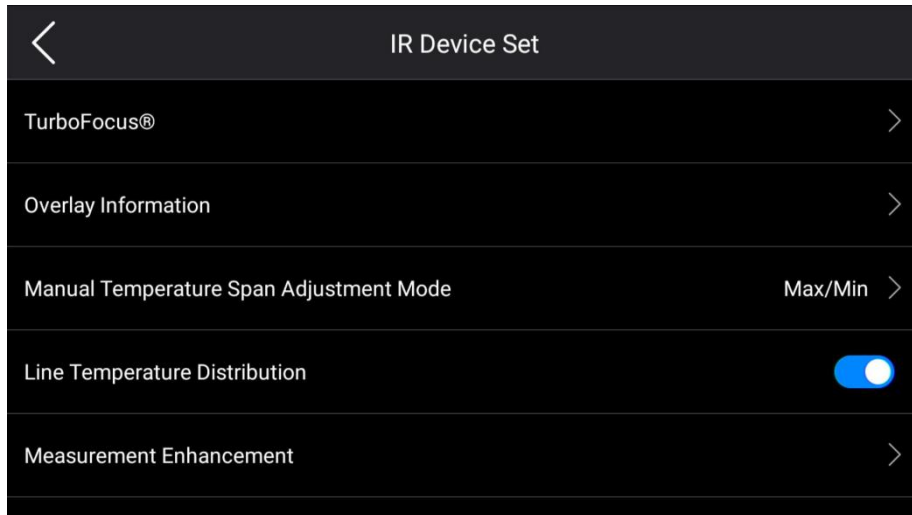

The line temperature distribution function of the device may vary depending on the specific model. Please refer to the actual device for details.

## 5. Regional Emissivity Correction (Partial Emissivity)

The device supports setting emissivity individually for each temperature measurement tool, allowing for precise temperature measurement in different areas. The specific operation steps are as follows:

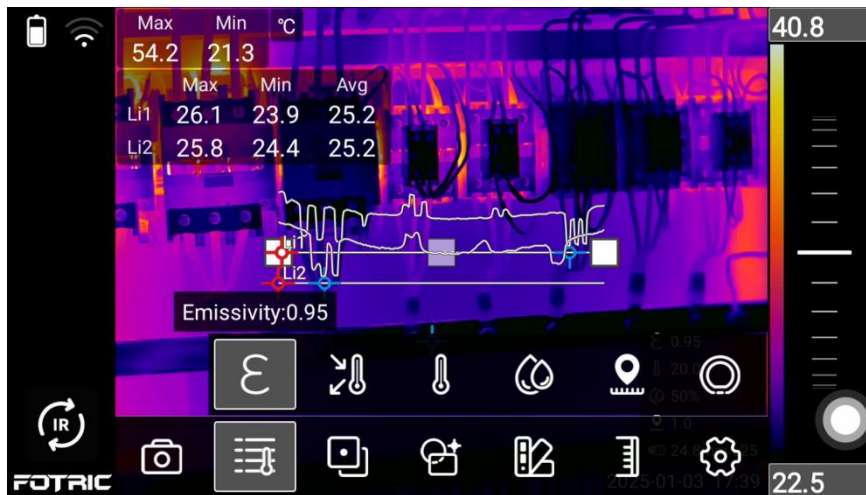

- ✧ On the main menu interface, press the OK button or touch the main menu to bring up the device menu.
- ✧ In the device menu, go to **ROI** → **Select a spot/area/line**.
- ✧ After selecting the ROI, press the OK button or touch the menu to bring up the temperature measurement object menu.
- ✧ In the temperature measurement object menu, go to **Emissivity**, enable/disable the function,

and adjust the corresponding parameters based on the measured target. The user can refer to **Appendix A: Emissivity Table** for guidance

## 6. Regional Alarm

The equipment supports temperature alarms for the measured target in the observed scene. The specific steps are as follows:

- ✧ On the main menu interface, press the OK button or touch the main menu to open the device menu.
- ✧ **Device menu → ROI → Display Settings**, enable the Maximum Temperature and Minimum Temperature options.
- ✧ **Device menu → ROI → Select.**



- ✧ After selecting the **ROI**, press the OK button or touch the menu to open ROI menu.
- ✧ **ROI menu → ROI Alarm Settings**, where the user can set the on/off status, alarm threshold, and silent/buzzer modes.
  - ✧ **High Temperature Alarm:** The alarm is triggered when the highest/lowest temperature in the area exceeds the alarm threshold.

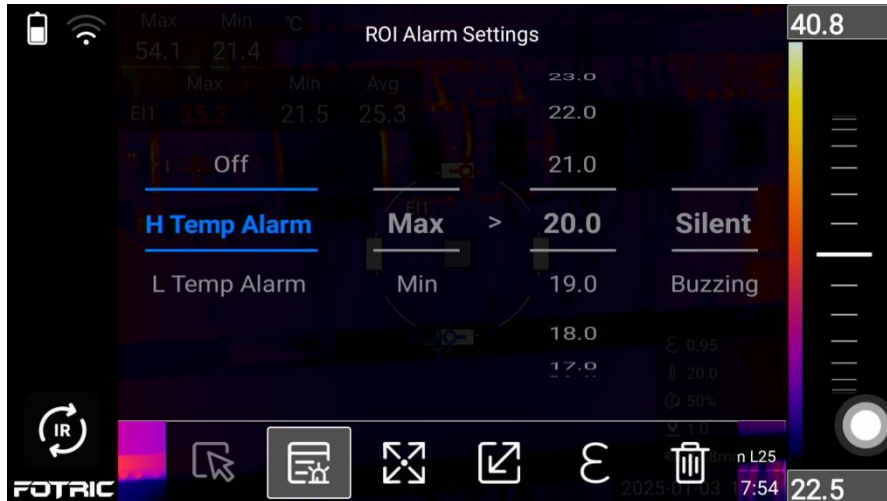

- ✧ **Low Temperature Alarm:** The alarm is triggered when the highest/lowest temperature in the area is below the alarm threshold.

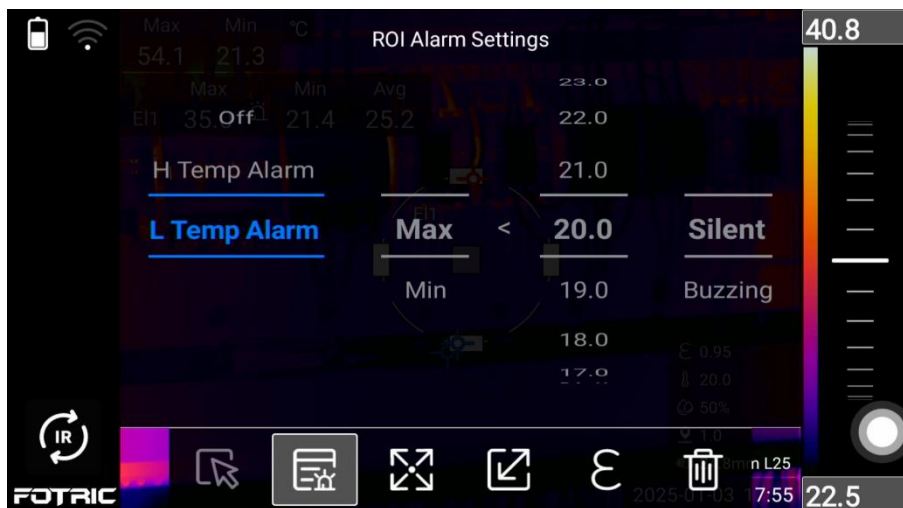

## 7. Temperature Rise

The device allows you to set a reference temperature, and all temperature values globally or within a specific region will be displayed as the difference from this reference temperature. The specific steps are as follows:

1. **Main menu interface:** Press the **OK** button or tap the main menu to open the device menu.
2. Go to **Settings** → **IR Device Set** → **Measurement Enhancement** → **Measurement Tools Extension Options**, and enable this function.
3. Navigate to **Device Menu** → **ROI** → **Add Temperature Rise**.
4. Configure the temperature rise's **On/Off status**, the **target**, and the **reference temperature Rise**.



## 8. On-device Analysis

The device supports quick analysis of thermal images and radiometric videos to help promptly identify, analyze, and resolve issues. The specific steps are as follows:

1. Press the **Gallery** button to enter the gallery homepage.
2. Use the **touchscreen** or **directional keys** to select the thermal image or radiometric video to be analyzed.
3. Press the **OK** button to enter the gallery preview interface.
4. Press the **OK** button again to bring up the gallery preview menu.
5. Tap the **Analyze** button to access the gallery analysis interface.



6. Analyze the thermal image data and save the results. Press the **Back** button to exit.



## 9. Analysis Software

The device supports expert analysis software, enabling real-time control and display of infrared thermal images, infrared data analysis, and rapid batch generation of professional reports. For detailed instructions, please refer to the user manual of the analysis software.

## 5. Thermal Imaging Basic Parameters

### 1. Super Resolution (SR)

Super Resolution is an image enhancement feature that improves image resolution and reduces noise, making smaller targets easier to distinguish and measure. A SuperResolution image has twice the width and height of a standard image. The operation steps are as follows:

1. In the **main interface**, press the **OK** button or tap the main menu to access the device menu.
2. Navigate to **Device Menu** → **Settings** → **Storage & Save Options** → **Save as Super Resolution**
3. Toggle the feature **On/Off**.
4. Alternatively, in the real-time view, swipe down from the top of the screen to bring up the system dropdown menu, and then toggle the 'Super Resolution'(SR) **On/Off**

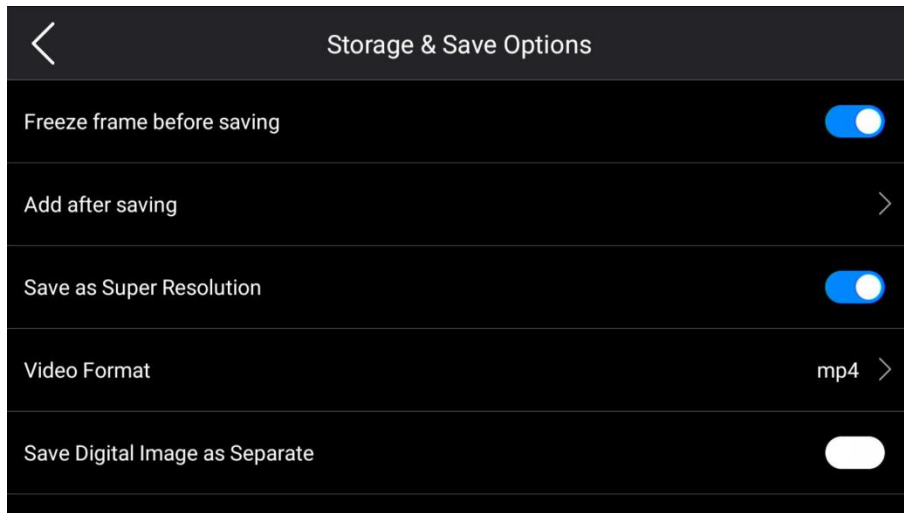

**Note:**

1. The availability of the Super Resolution feature depends on the specific device model. Please refer to the actual device for details.
2. The Super Resolution feature only supports single-frame capture of infrared images. Otherwise, the images will retain their original resolution.

## 2. Focus Mode

Focusing allows the device to capture clearer and more accurate images, ensuring optimal image quality for analysis.

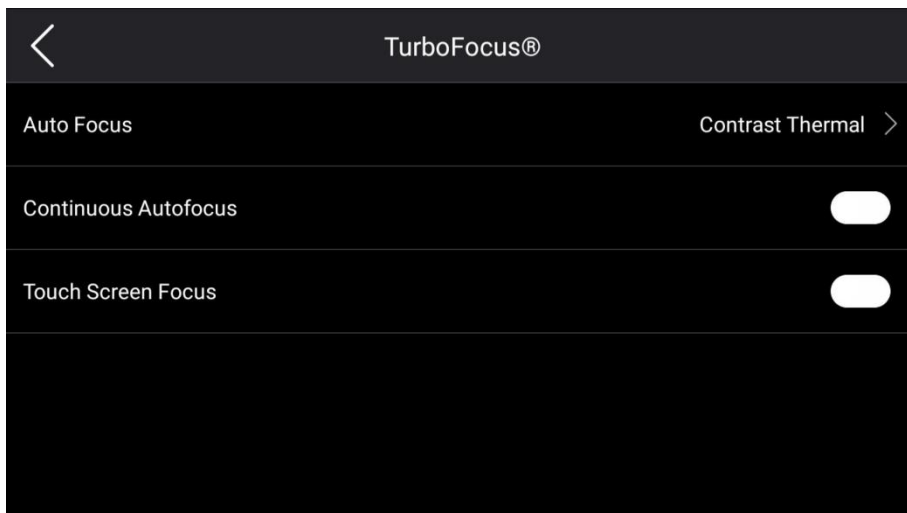

---

## 2.1. Manual Focus

Manual focusing is achieved by manually rotating the focus ring. To focus the device, aim the lens at the object to be observed and rotate the focus wheel located next to the lens in a clockwise or counterclockwise direction to adjust the clarity of the image.

## 2.2. Auto Focus

Users can press the **Auto Focus** button to automatically focus the device. The specific steps are as follows:

1. In the **main menu interface**, press the **OK** button or tap the main menu to access the device menu.
2. Navigate to **Device Menu → Settings → IR Device Set → Turbo Focus® → Auto Focus**.
3. Choose either **Contrast Thermal** or **Laser** for focusing:
  - 3.1 **Contrast Thermal**: Adjusts the focus based on maximizing image contrast.

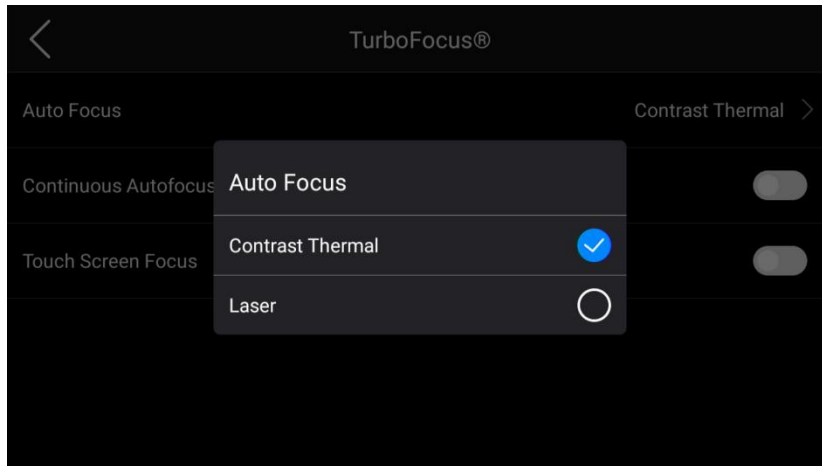

- 3.2 **Laser**: Adjusts the focus based on laser distance measurement.

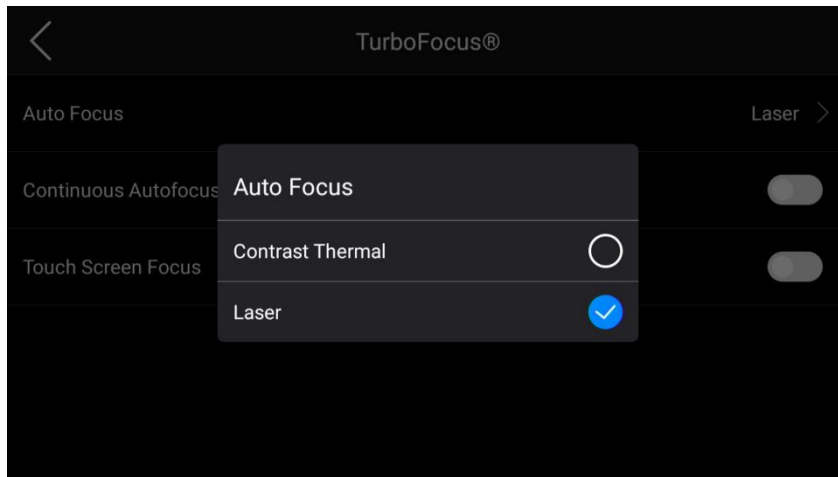

Aim at the target, and press the **Auto Focus** button to initiate the focus adjustment.

### 2.3. Continuous Focus

The device can be set to perform continuous auto focusing. The specific steps are as follows:

1. In the **main menu interface**, press the **OK** button or tap the main menu to access the device menu.
2. Navigate to **Device Menu → Settings → IR Device Set → Turbo Focus® → Continuous AutoFocus**.
3. The user can **enable** or **disable** this feature.

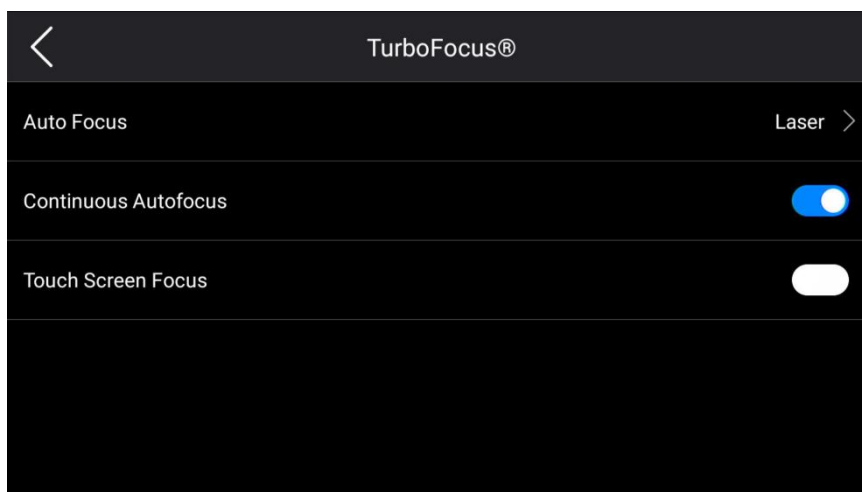

### 2.4. Touch Screen Focus

The device can also be set for touch focusing. The specific steps are as follows:

1. In the **main menu interface**, press the **OK** button or tap the main menu to access the device menu.
2. Navigate to **Device Menu → Settings → IR Device Set → Turbo Focus® → Touch Screen Focus**
3. The user can **enable** or **disable** this feature.
4. After enabling Touch Screen Focus, the user can tap on the visible area of the infrared image (where no menu or image overlay information is active) to automatically focus on the target area.

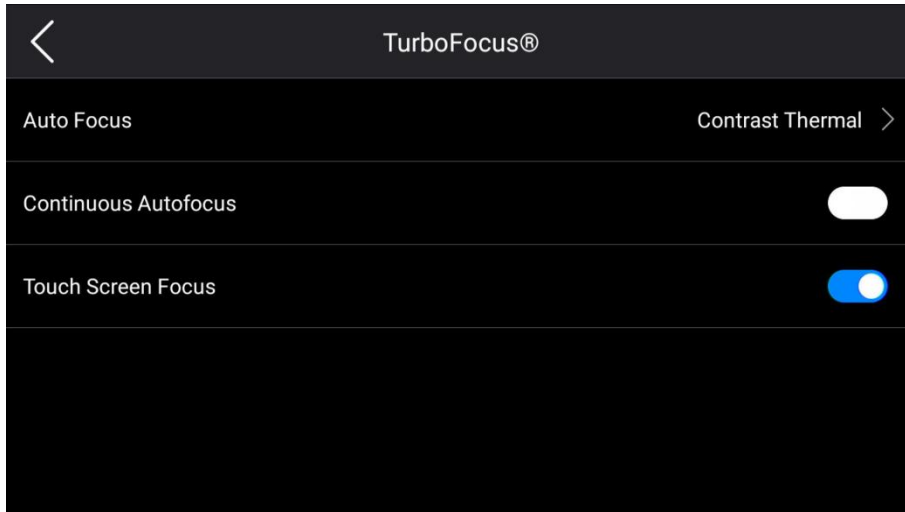

**NOTE:**

If the device is set to laser auto focus, do not aim the device at a person's face when using the auto focus or continuous auto focus function, as the laser beam may cause eye discomfort.



**NOTE:**

The focusing function on the device depends on the specific model. Please refer to the actual device for details.

### 3. IR Device Settings

Thermal settings include **Turbo Focus®**, **Overlay information**, **Manual Temperature Span adjustment Mode**, **Line Temperature distribution**, and **Measurement Enhancement**. The Measurement Enhancement is further divided into **Image Enhancement**, **Palette Extension**, and **Measurement Tools Extension**.

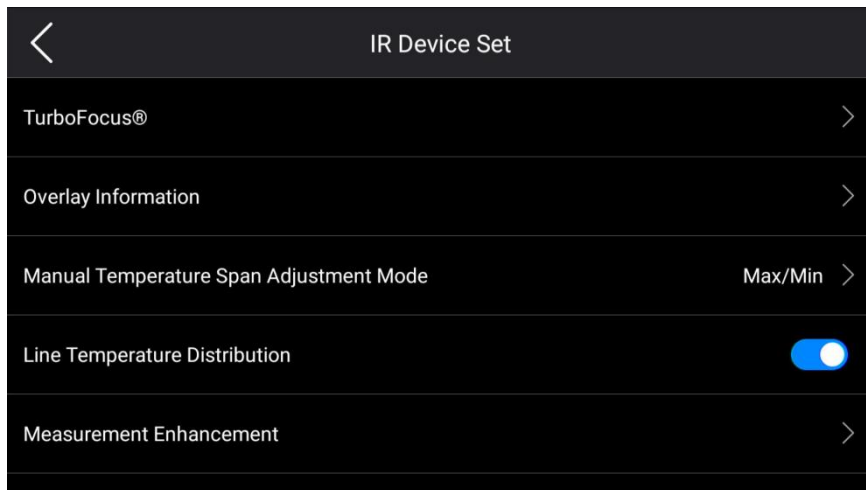

## 6. Acoustic Imaging Display

### 1. Sound Source Mode

The sound imaging device can detect sound sources in various modes, which can be switched according to your preferences. The specific operation steps are as follows:

1. Switch to the "AC" interface by tapping the "IR" button in the lower-left corner of the screen.
2. In the main menu interface, press the OK button or tap the main menu to bring up the device menu.

#### 3. Device Menu → Sound Source Mode

#### 1.1. Single Sound Source

Overlay the sound image of multiple high sound pressure areas on the visible light image. The specific operation steps are as follows:

1. **Main menu interface:** Press the OK button or tap the main menu to bring up the device menu.

## 2. Device menu → Sound source mode → Multiple sound sources

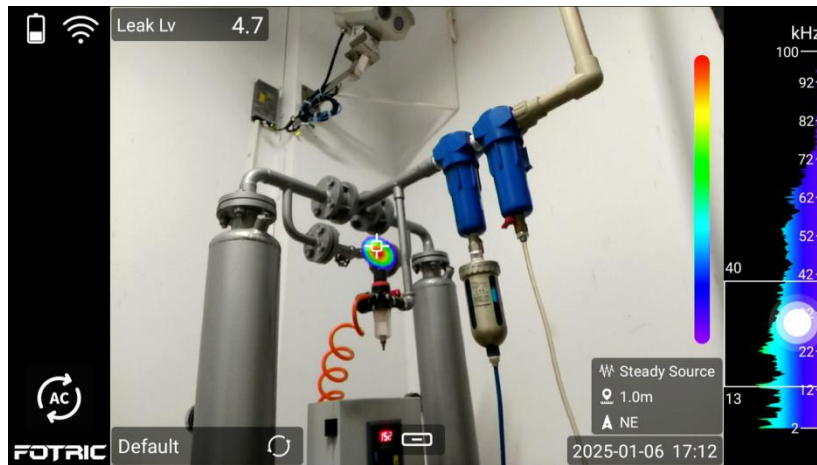

### 1.2. Multi Sound Source

Overlay the sound image of multiple high sound pressure areas on the visible light image. The specific operation steps are as follows:

3. **Main menu interface:** Press the OK button or tap the main menu to bring up the device menu.
4. **Device menu → Sound source mode → Multiple sound sources**

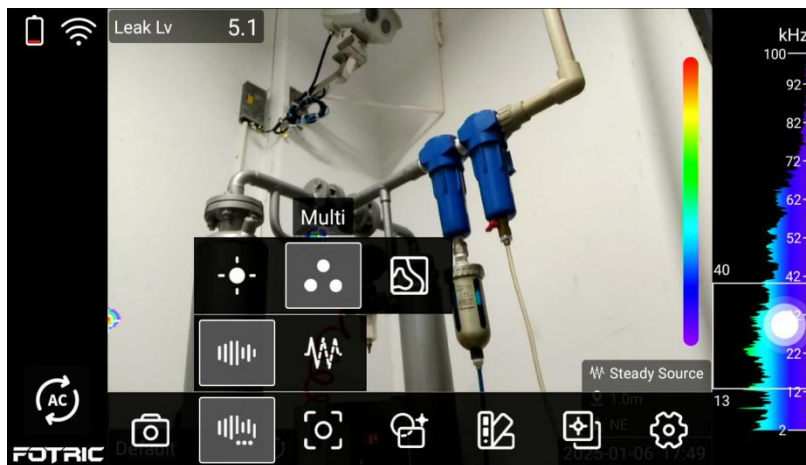

### 1.3. Hologram

Adjust the sound pressure threshold and overlay the sound image of the areas above the threshold on the visible light image. The specific operation steps are as follows:

1. In the main menu interface, press the OK button or tap the main menu to bring up the device menu.
2. **Device menu → Sound source mode → Hologram**



## 2. Palettes

The color palette can be changed to display different high sound pressure areas, and it supports adjusting the transparency with three available color palettes. The specific operation steps are as follows:

1. In the main menu interface, press the OK button or tap the main menu to bring up the device menu.
2. **Device menu** → **Color palette** (adjustable: red-blue, iron red, gray-white).
3. **Device Menu** → **Palette** → **More** → Tap the icon in the upper right corner to adjust the transparency of the palette.

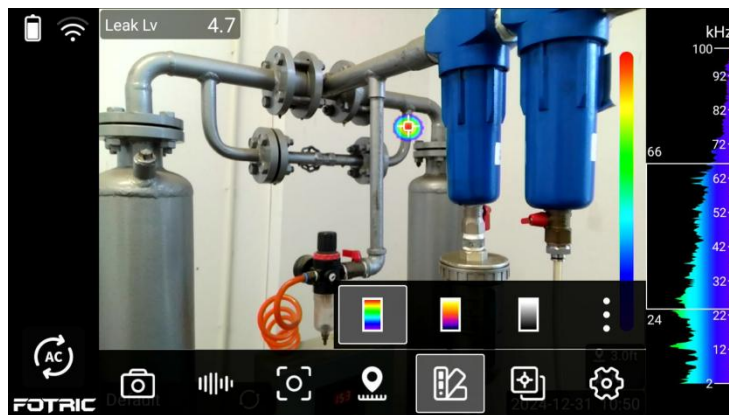

## 3. Black and White Background

During acoustic imaging detection, the color visible light image can be displayed as a black-and-white grayscale visible light image. The specific steps are as follows:

1. In the main menu interface, press the OK button or tap the main menu to open the device menu.
2. Navigate to **Device Menu** → **Palette** → **More** → Tap the second icon in the upper right corner to switch the image to a black-and-white background

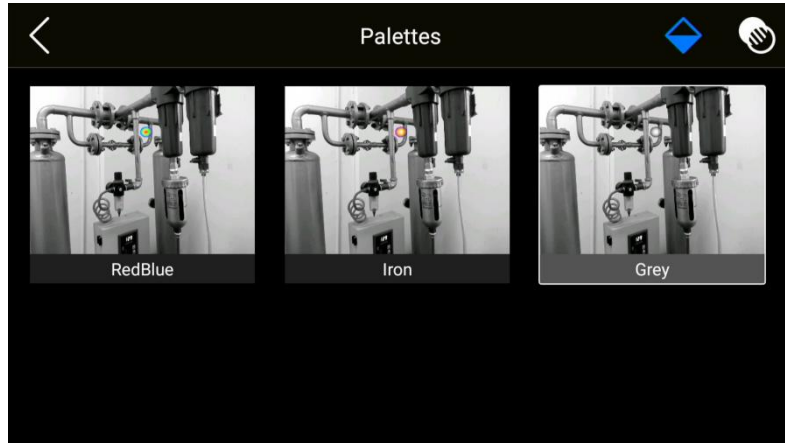

#### 4. Transient Mode (T-FFTD®)

Capture transient sound signals and allow them to remain on the real-time acoustic image for a longer duration, assisting in identifying issues such as intermittent leaks, partial discharges, vibrations, and abnormal noises. The specific steps are as follows:

1. In the main menu interface, press the OK button or tap the main menu to access the device menu.
2. Navigate to **Device Menu** → **Settings** → **AC Device Set** → **Measurement Enhancement** → **Enable T-FFTD®**.
3. Return to the main menu interface → **Acoustic Parameters** → **T-FFTD®** (the user can choose between transient sound sources or steady-state sound sources).

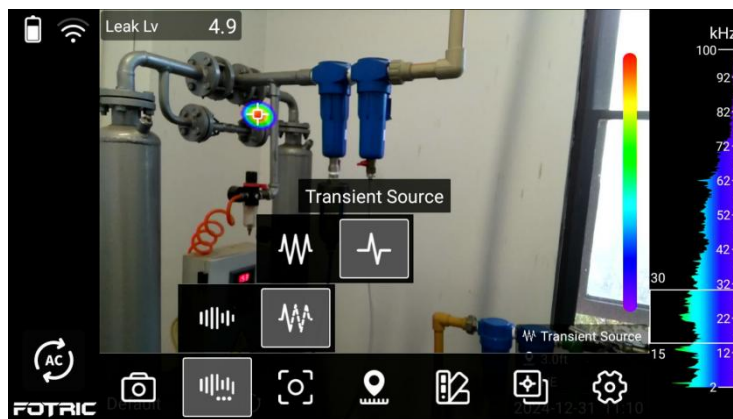

#### 5. Digital Zoom

The device's digital zoom function allows control over image zoom display. The specific steps are as follows:

1. **Zoom In:** Use two fingers to touch the screen and spread them apart.
2. **Zoom Out:** Use two fingers to touch the screen and pinch them together.
3. When the zoom level exceeds 1x, a zoom slider wheel will appear:
  1. Adjust the zoom level by sliding the wheel on the touch screen or using the left/right directional keys.
  2. Press the OK button or the Back button to hide the zoom slider wheel.
  3. Alternatively, tap the zoom level value again to reactivate the zoom adjustment slider.

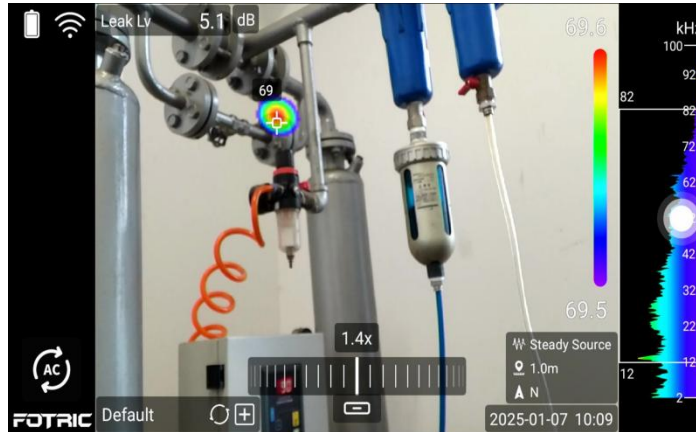

## 6. Image Overlay Information

The device can overlay parameters, sound pressure values, and other information onto image files. The specific steps are as follows:

### Leakage Mode:

1. Displays leakage evaluation parameters and results Including measurement parameters, compass information, as well as date and time information.

### Partial Discharge Mode:

1. Displays partial discharge diagnostic parameters, PRPD patterns, and results Including measurement parameters, compass information, as well as date and time information.

## 7. Sound Pressure Tracking

To automatically track the maximum sound pressure using special markers and overlay the acoustic image of the strongest sound pressure area on the visible light image,



## 7. Acoustic Measurement Analysis

### 1. Frequency Range Selection

Supporting Pre-configured Frequency Ranges for Different Scenarios and Manual Adjustment of Frequency Bands.

1. Main menu interface: Press the OK button or tap the main menu to bring up the device menu
2. Device Menu → Settings → AC Device Set → Enable Frequency Configuration
3. Return to the real-time screen and tap the bottom left corner to customize the frequency band range



### 2. Measurement Tools

The device allows for measurement of specific locations, boundaries, or areas by setting points, circles.



## 2.1 Add Spot

The specific steps are as follows:

1. In the main menu interface, press the OK button or tap the main menu to bring up the device menu
2. **Device menu → Settings → AC Device Set → Measurement Enhancement → Enable Measurement Tool**
3. **Return to the main interface → Device menu → Measurement Tools → Add Spot.**
4. Tap the selected measurement point, drag it or use the directional keys to move and adjust the spot's position.

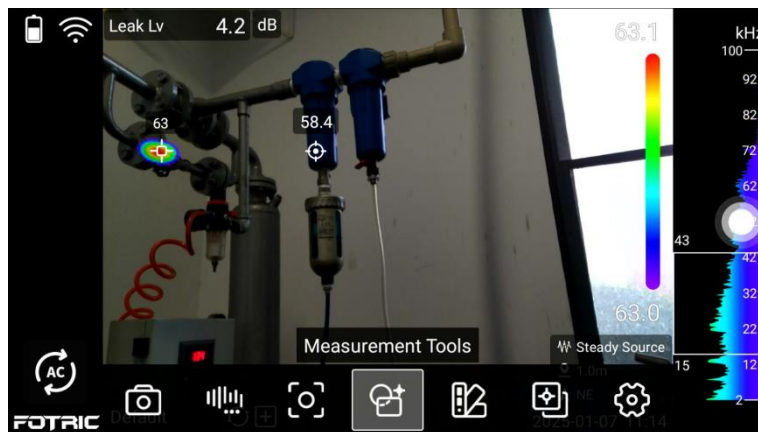

## 2.2 Add Circle

The specific steps are as follows:

1. In the main menu interface, press the OK button or tap the main menu to bring up the device menu.

2. Device menu → Settings → AC Device Set → Measurement Enhancement → Enable Measurement Tool
3. Return to the main interface → Device menu → Measurement Tools → Add Circle.
4. Tap the selected measurement circle, drag it or use the directional keys to move and adjust the position of the measurement circle.

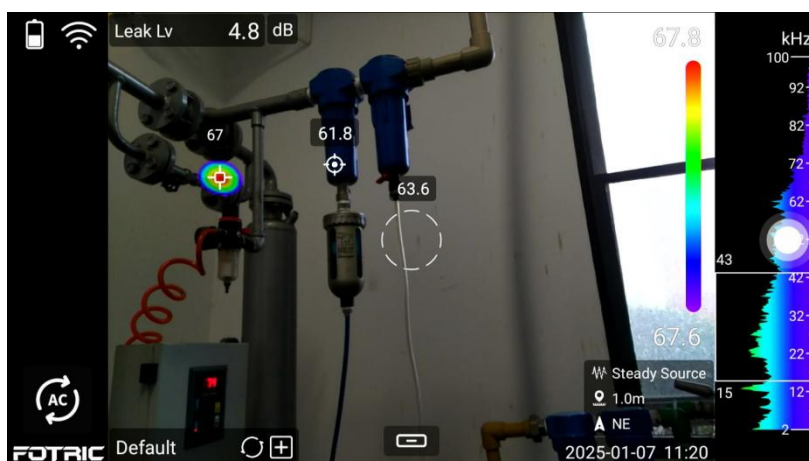

### 3. Detection Mode

The **Detection Modes** are divided into two types: **Partial Discharge Mode** and **Leak Detection Mode (Leakage Evaluation Mode)**



The detection modes on the device depend on the specific model. Please refer to the actual device for the available detection modes.

### 4. Partial Discharge Mode

The device is equipped with **Partial Discharge (PD) Detection** functionality, along with various intelligent features that significantly enhance the user's detection efficiency, ensuring quick and accurate fault diagnosis and maintenance.

**Partial Discharge Diagnosis: Supports diagnostic types, discharge probability, AC frequency, and PRPD graph.**

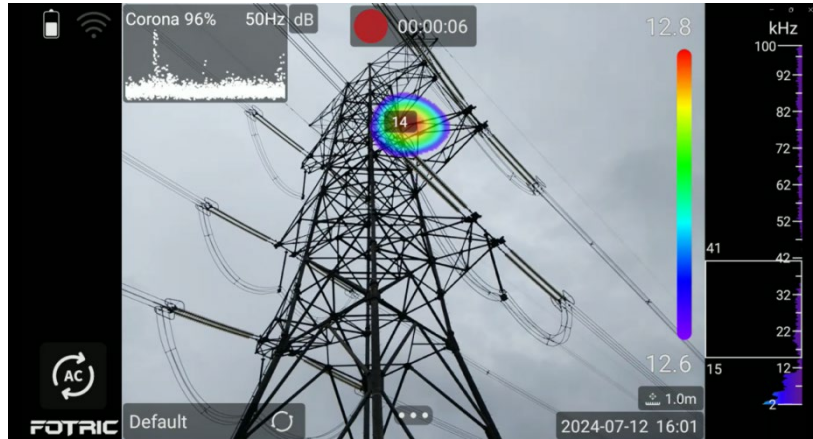

## 4.1. AC Frequency

The AC frequency is only applicable in **Partial Discharge Mode** and is adaptable to different AC frequencies (50/60Hz). The specific steps are as follows:

1. In the main menu interface, press the OK button or tap the main menu to bring up the device menu.
2. **Device menu** → **Settings** → **AC Device Set** → **AC Frequency** (Change to the appropriate frequency based on the usage scenario).

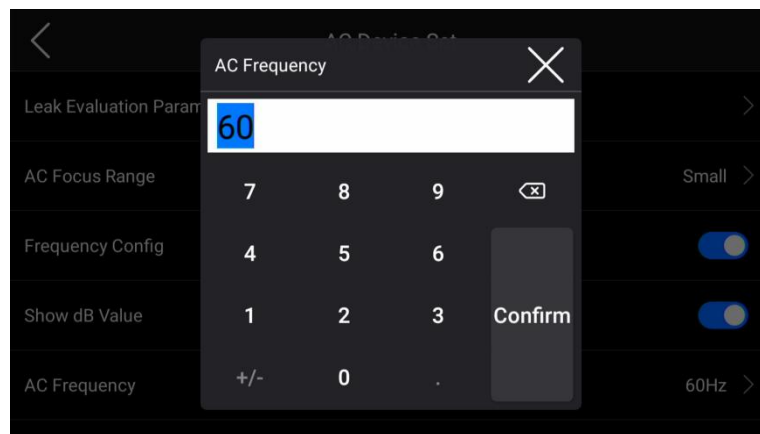

## 5. Leakage Evaluation Mode

The device is equipped with **Gas leak detection** functionality and comes with various intelligent features that significantly enhance detection efficiency, ensuring fast and accurate fault diagnosis and maintenance.

**Leakage Assessment: Supports leakage level, leakage rate, and cost**

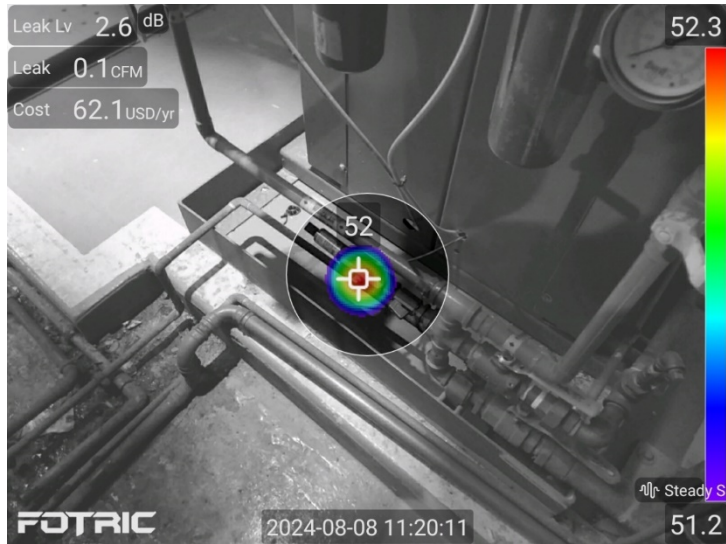

## 6. Acoustic Image Focus

To shield surrounding areas and focus on a specific region's acoustic image, minimizing noise interference and emphasizing key positions, please conduct the following steps:

1. In the main interface, press the OK button or tap the main menu to bring up the device menu
2. Device menu → Acoustic Image Focus
3. Device menu → Settings → AC Device Set → Acoustic Image Focus Range (The user can adjust the size of the focus ring)

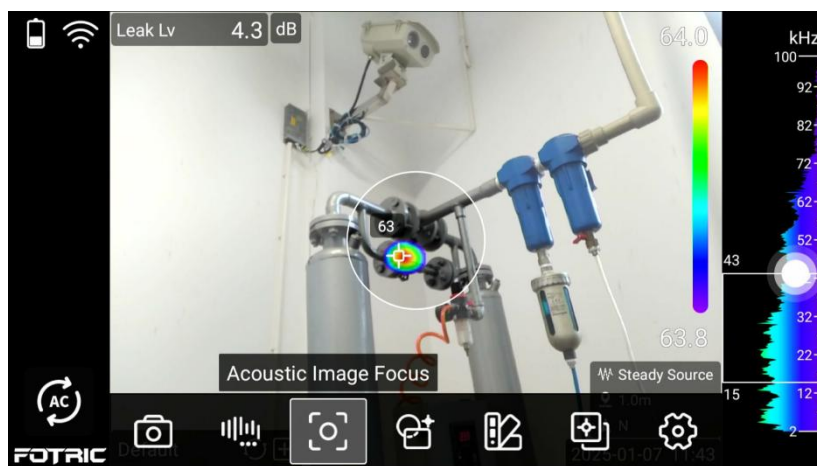

## 7. On-device Analysis

The device supports quick analysis of thermal images and holographic acoustic videos to promptly identify, analyze, and resolve issues. The specific operation steps are as follows:

1. Press the gallery button to enter the gallery homepage.
2. Use the touch or directional buttons to select the thermal image or radiometric video to be analyzed.
3. Press the OK button to enter the gallery preview interface.
4. Press the OK button again to bring up the gallery preview menu.
5. Click the "Analyze" button to enter the gallery analysis interface.
6. Analyze the acoustic image data and save the results.
7. Press the back button to exit.

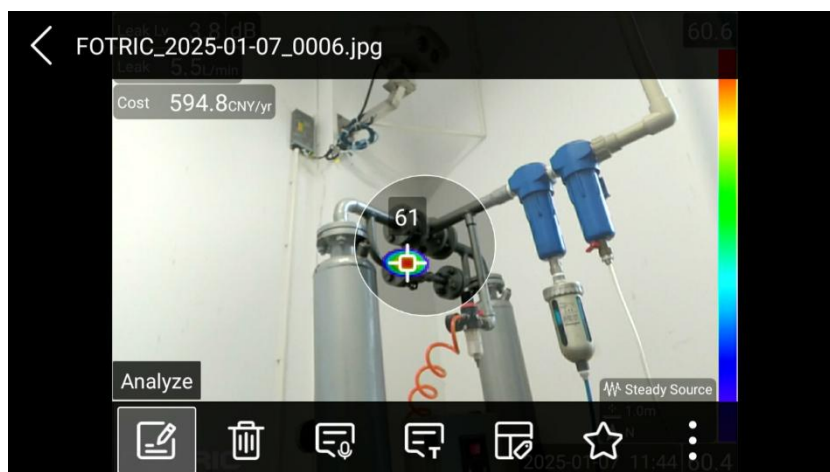

---

## 8. Analysis Software

The device supports professional analysis software, which allows for real-time control and display of acoustic images, analysis of acoustic image data, and quick batch generation of professional reports. For detailed operations, please refer to the user manual of the analysis software.

## 8. Acoustic Imaging Basic Parameters

### 1. Distance

The distance to the sound source is calculated in real-time through the acoustic sensor's received sound signals. The specific operation steps are as follows:

1. In the main menu interface, press the OK button or tap the main menu to bring up the device menu.
2. Device menu → Target distance (adjust based on the test scenario).
3. Find and press the device's laser key for a long press; the device will automatically measure the distance.

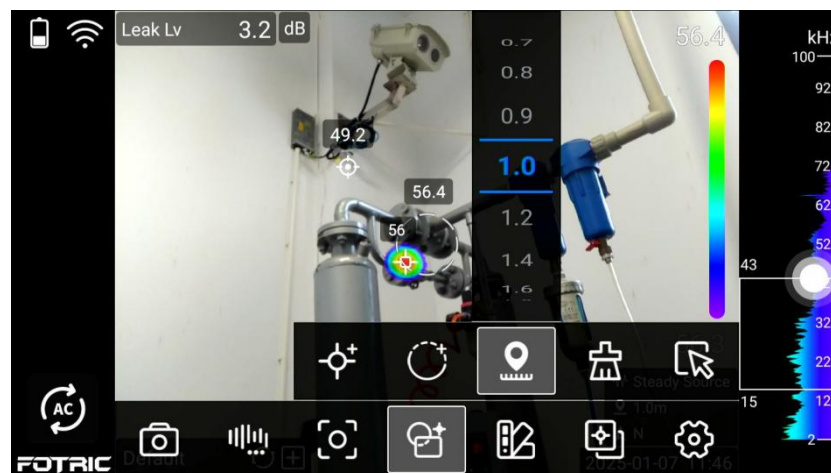

### 2. AC Device Set

**AC Device Set** includes: Leak Evaluation Parameters (see Appendix B for more information), AC Focus Range, Frequency Config, Show dB values, AC frequency, SPL Normalization, and Measurement Enhancement. The specific operation steps are as follows:

1. In the main menu interface, press the OK button or tap the main menu to bring up the device menu
2. Device Menu → Settings → AC Device Set

- 
3. Enter the AC Device Set page where the user can configure each parameter as needed

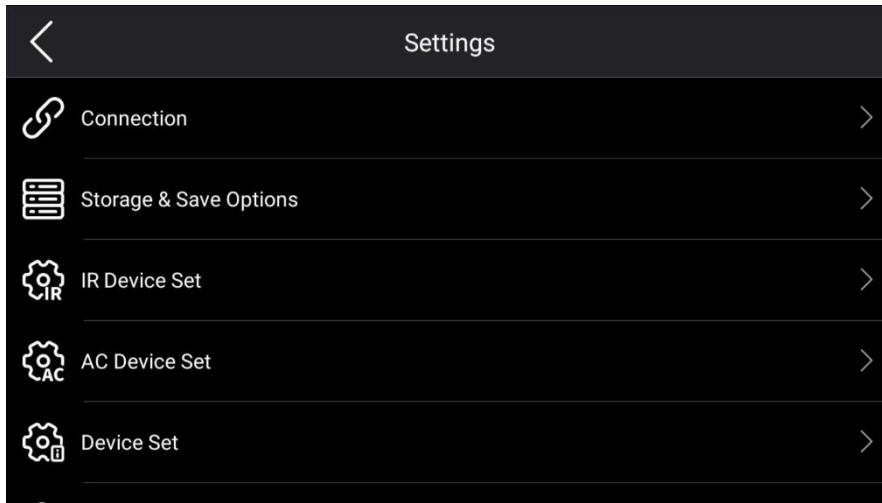

## 9. Capture Functions

### 1. Single Frame Capture

Capture an image in the main menu interface and save it to the device's storage card.

#### Operation steps:

1. In the main menu interface, press the OK button or tap the main menu to bring up the device menu
2. **Device menu → Capture Mode → Single Frame Capture**
3. Press the shutter button to freeze the image. For operations related to freezing the image, please refer to section 5, "Freezing the Image."
4. Press the shutter button again to capture a single image

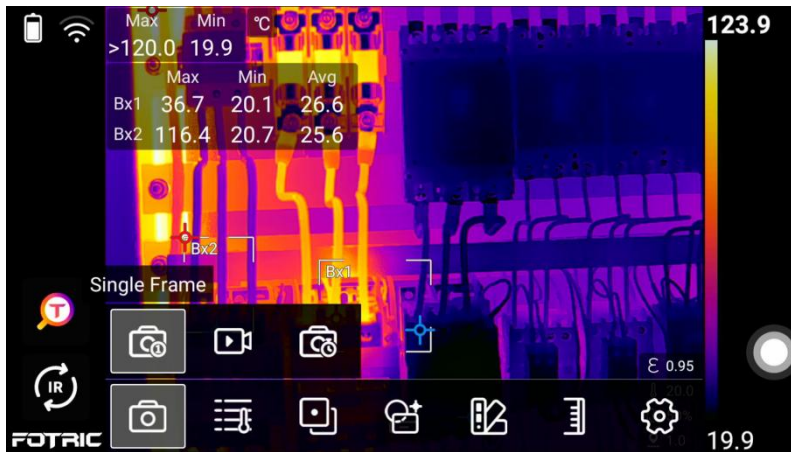

**NOTE**

- To enable freeze frame before saving, follow steps 1, 2, 3, and 4
- If freeze frame before saving is not enabled, follow steps 1, 2, and 4
- To enable/disable freeze frame before saving, go to **"Settings → Storage and Save Options.->Freeze Image Before Saving"**

## 1.1 File Naming Format

### Named by Date & No.

To use a date-based serial number for naming files:

1. In the main menu interface, press the OK button or tap the main menu to bring up the device menu.
2. **Device menu → Settings → Storage and Save Options → Choose "Named by Date & No." under File naming format.**
3. Complete a single-frame capture (File name: Named by Date & No ). **Go to the gallery → Image preview → File properties, and check the file name: Named by Date & No.**

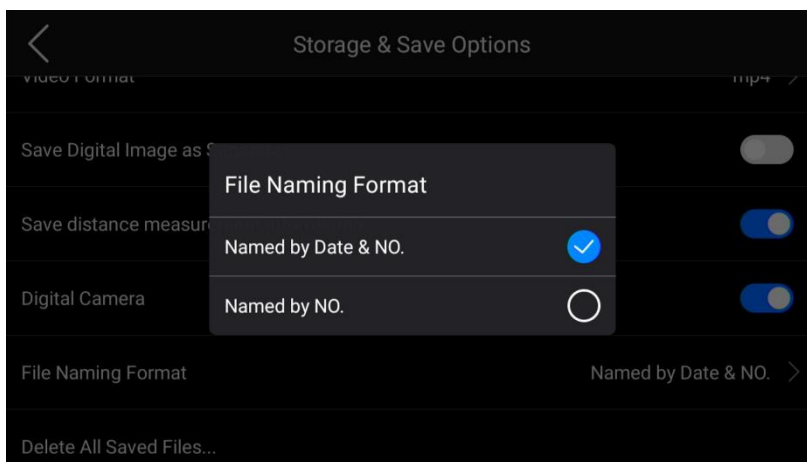

### Named by NO.

1. In the main menu interface, press the OK button or tap the main menu to bring up the device menu.

---

2. **Device menu → Settings → Storage and Save Options → Choose "Named by No."** under File naming format.

3. Complete a single-frame capture (File name: Named by Date & No ). **Go to the gallery → Image preview → File properties, and check the file name: Named by No.**

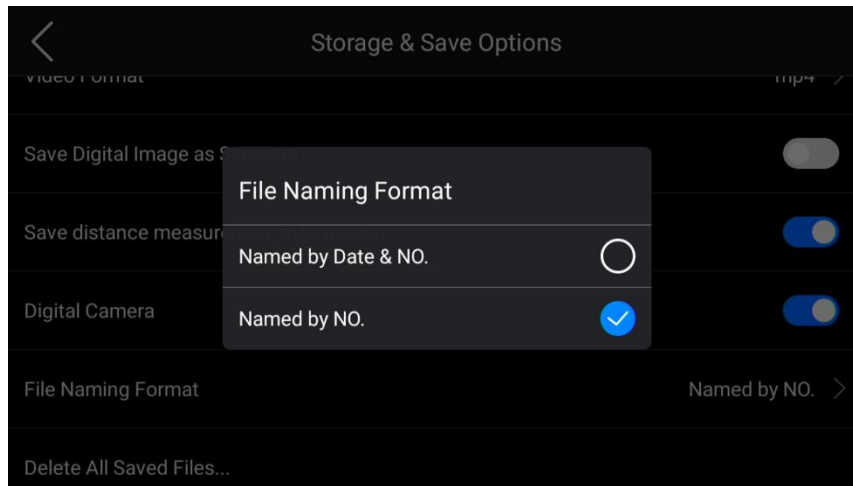

## 2. Time-lapse Capture

Set a time interval ranging from 2 seconds to 1 hour to automatically save images in infrared, T-DEF® Blend, or picture-in-picture mode, and store them on the device's memory card.

### Time-lapse Capture Operation Steps :

1. In the main menu interface, press the OK button or tap the main menu to bring up the device menu.
2. **Device menu → Capture Mode → Time-lapse Capture.**
3. In the Time-lapse Capture menu, press OK or tap the Time-lapse Capture menu to set the time-lapse capture parameters.
4. Press the capture button to start Time- lapse capture.
5. Press the capture button again to stop the Timed-lapse capture.

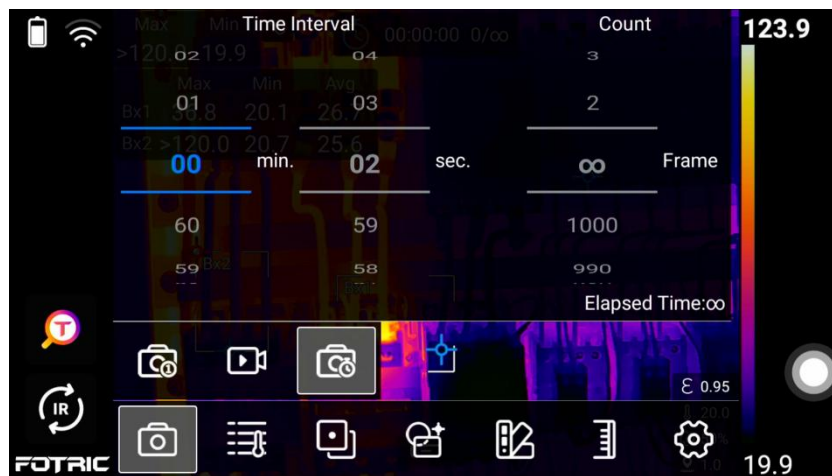
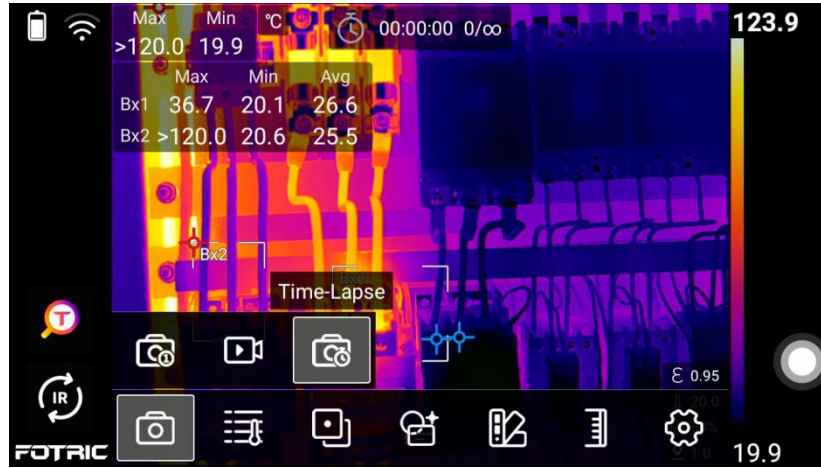

## NOTE

1. The Time-lapse capture mode on the device depends on the specific model, please refer to the actual device for details.

During the Time-lapse capture process, only focusing operations and stopping the Time-Lapse capture are allowed. No other operations are supported.

## 3. Video Recording

The device can record video clips and save them to the storage card, supporting IRS or IRSX, ACS, and MP4 file formats.

- **IRS or IRSX** (Radiometric video): This format is used for radiometric video and is supported only in thermal image mode.
- **ACS** (Holographic acoustic video): This format is used for holographic acoustic videos and is supported only in acoustic image mode.
- **MP4** (Standard video): This format is used for regular videos and is supported in all modes except radiometric recording.

Radiometric recording supports only thermal image mode, while holographic acoustic video recording supports only acoustic image mode. Non-radiometric recording is supported in all modes.

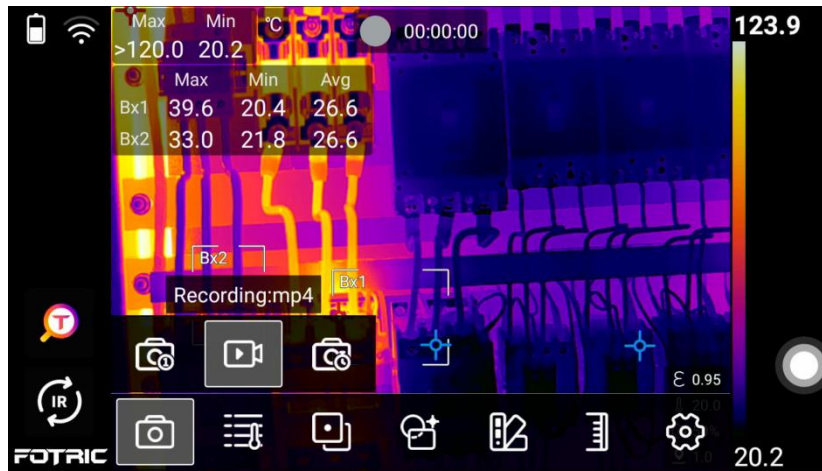

### 3.1 Radiometric Video Recording

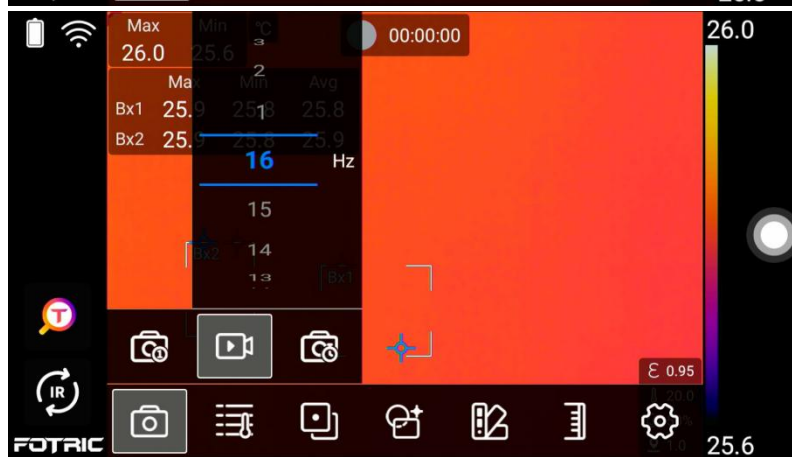
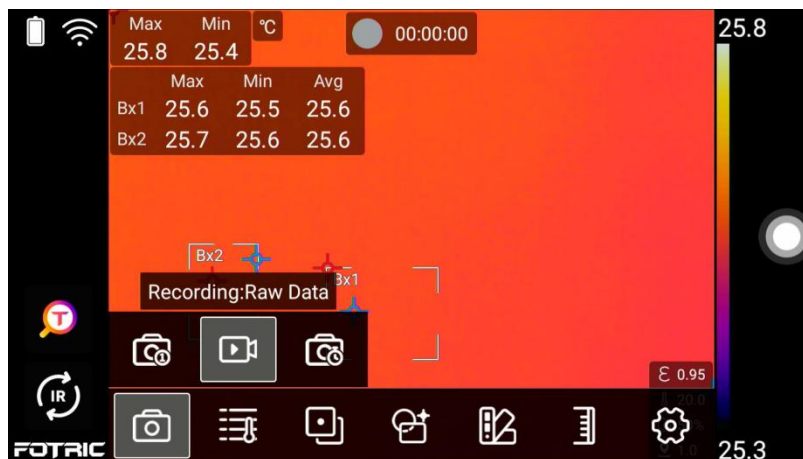

1. The radiometric video recording mode on the device depends on the specific model, please refer to the actual device
2. The video format selection can be set through the following path:  
**Settings → Storage and Save Options.**

### 3.2 Holographic video recording

Supports analyzable holographic video recording up to 7 minutes long and saved on the device's memory card.

Steps:

1. In the main menu interface, press the OK key/tap the main menu to bring up the device menu, and select the original video in the video format;
2. **Device menu → Capture Mode → Recording: Raw data;**
3. Recording menu, press OK key/touch the recording menu to set the recording frame rate of holographic pan video;
4. Press the photo button to start recording the holographic audio and image video;
5. Press the photo button again, and the holographic sound and image video recording is completed.

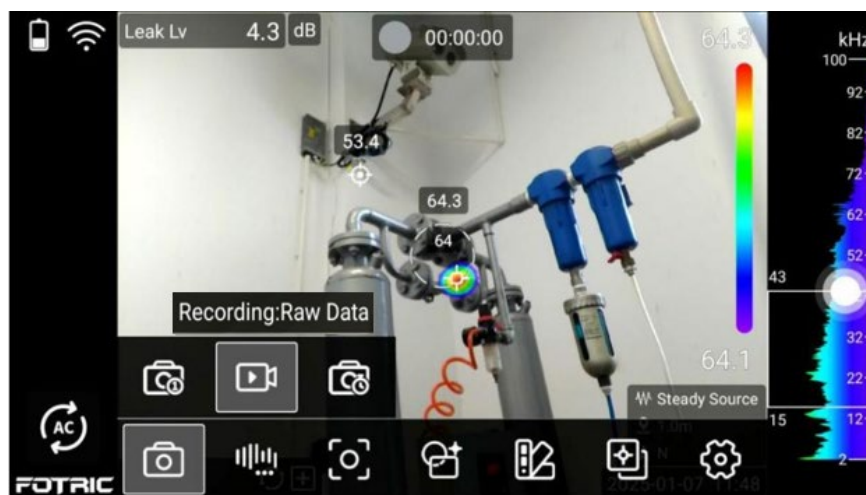

#### NOTE

1. The full radiation video recording mode on the device depends on the specific model, so please refer to the actual device.
2. The video format selection can be set through "Settings → Storage and Save Options."

### 3.3 MP4 Video Recording

Supports MP4 video recording in various image modes, and saves the video to the device's storage card.



### Operation Steps:

1. In the live interface, press the OK button or tap the main menu to bring up the device menu, then select MP4 as the video format.
2. Go to **Device Menu** → **Capture Mode** → **Recording: MP4**.
3. Press the shutter button to start recording the MP4 video.
4. Press the shutter button again to finish the MP4 video recording

### NOTE

- The MP4 video recording mode on the device depends on the specific model, so please refer to the actual device for details.
- The video format selection can be set through "Settings → Storage and Save Options."

## 3.4 Video Format

### Raw data

1. In the live interface, press the OK button or tap the main menu to bring up the device menu.
2. **In the device menu** → **Settings** → **Storage and Save Options**, select "**Raw Data**" for the video format.

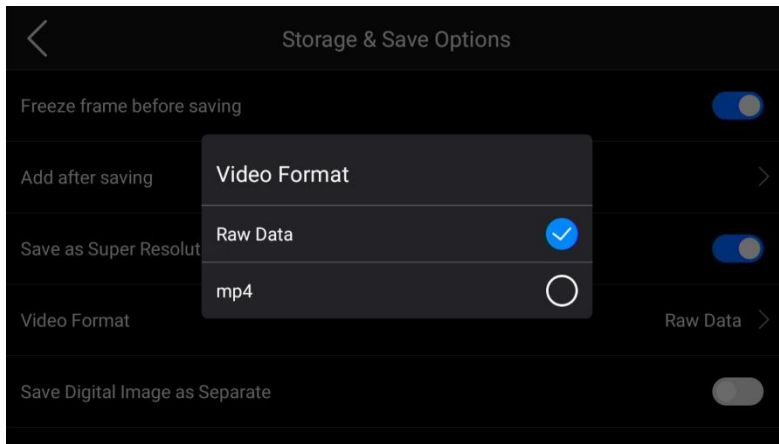

## MP4

1. In the live interface, press the OK button or tap the main menu to bring up the device menu.
2. In the device menu → Settings → Storage and Save Options, select "MP4" for the video format.

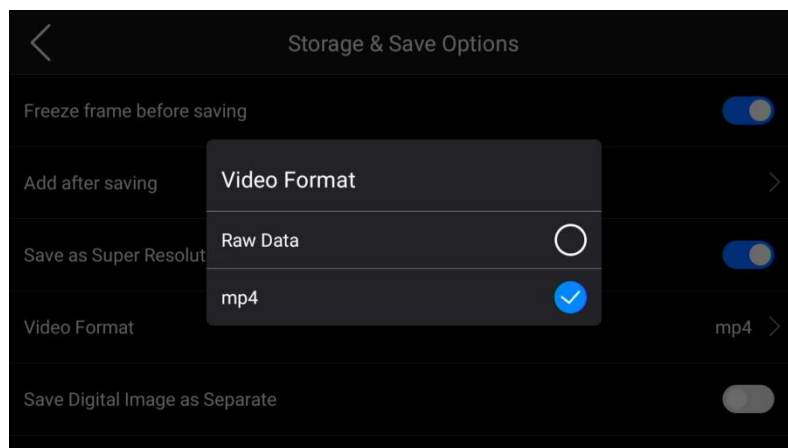

## 4. Freeze Interface

In infrared image, visible light temperature measurement (T-DEF®), and picture-in-picture modes, when taking a single frame, the freeze frame function can be enabled for preview.

**Operation Steps:** In single-frame capture mode, press the snapshot button to enter the freeze frame for the image.

### Temperature Measurement Parameters:

Please refer to **Thermal Imaging Measurement and Analysis** → 4.2. Global Temperature Measurement Parameters.

---

### Temperature Measurement Tools:

Please refer to **Thermal Imaging Measurement and Analysis** → 4.3.Measurement Tools (ROI)

### Voice Annotation:

Please refer to **Capture Functions** → 9.6 Voice Annotation.

### Text Annotation:

Please refer to **Capture Functions** → 9.7 Text Annotation.

### Tag Table

Please refer to **Capture Functions** → 9.8 Tag Table

### Favorites:

Please refer to **Capture Functions** → 9.9 Favorites

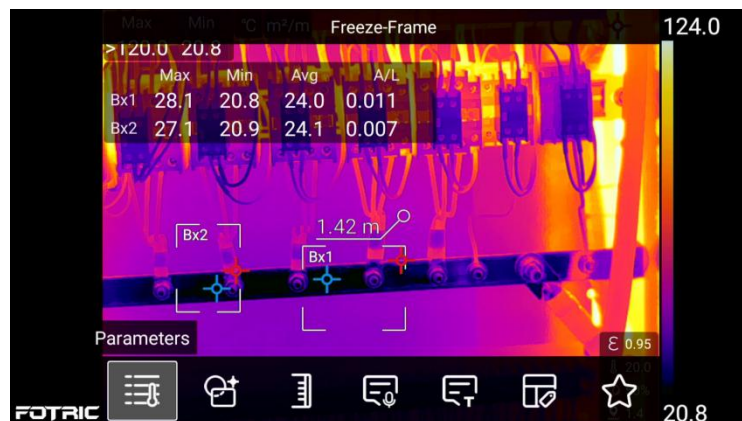

The freeze function on the device depends on the specific model. Please refer to the actual device for details.

## 5. QR Code Scan

Scan the QR code to use it as a text note and tag.

Steps for Operation:

1. Freeze the screen or preview the gallery, press the OK button or tap the main menu to bring up the device menu.
2. In the device menu, go to Text Annotation → Scan QR Code
3. Tap , and align it with the QR code to be scanned, displaying the QR code content;
4. Tap the "Save" button to successfully save the QR code content.

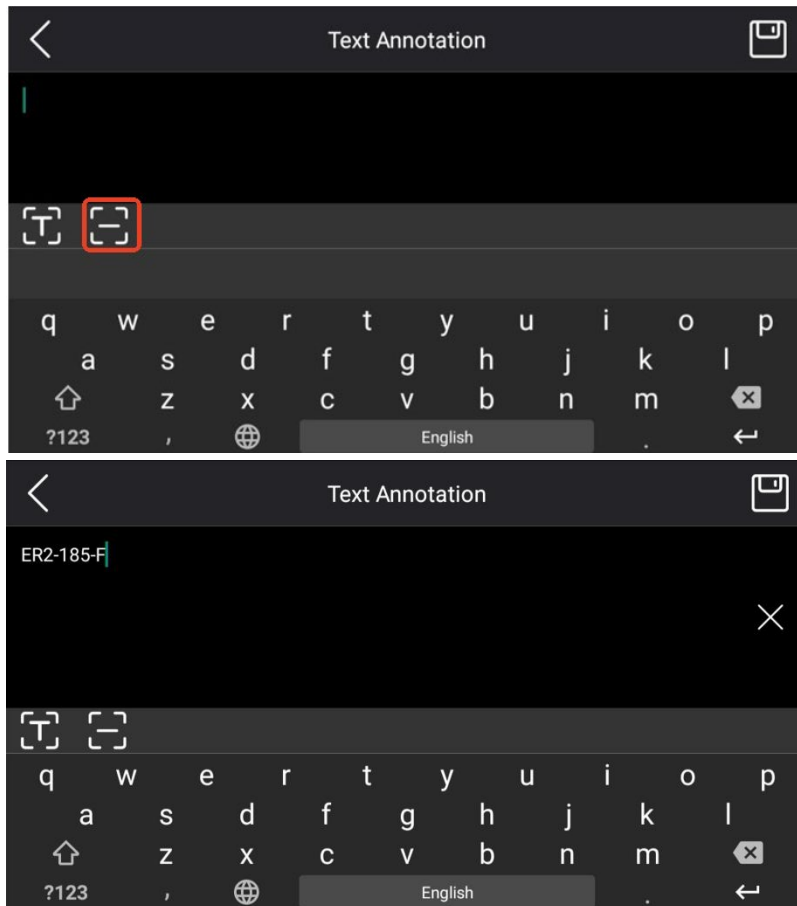



The QR code function on the device may vary depending on the specific model. Please refer to the actual device.

## 6. Voice Annotation

Record Voice Annotation with a maximum duration of 120 seconds and save it to the thermal image and full radiation video.

### Steps for operation:

1. Freeze the screen or preview the gallery, press the OK button or tap the main menu to bring up the device menu.
2. In the device menu, go to Voice Annotation.
3. Tap  to start recording the voice annotation.
4. Tap  to stop recording the voice annotation.
5. Tap  to play the recorded voice annotation.
6. Tap the button to delete the recorded voice annotation.

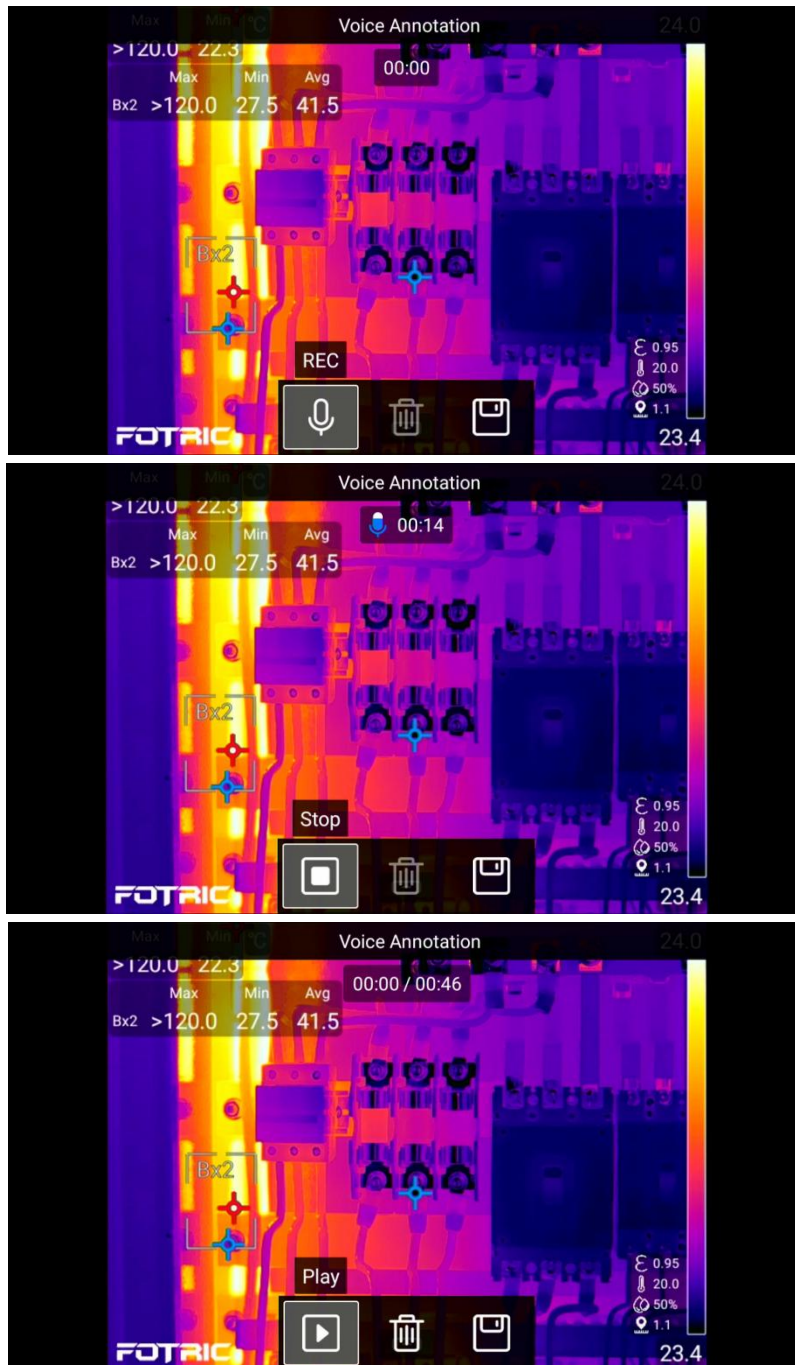

 **NOTE**

The voice annotation function on the device may vary depending on the specific model. Please refer to the actual device.

## 7. Text Annotation

### Steps for operation:

1. Freeze the screen or preview the gallery, press the **OK button** or tap the **main menu** to bring up the device menu.

2. In the device menu, go to **Text Annotation**.
3. After successfully inputting through manual keyboard entry, OCR text recognition, QR code scanning, or tap the **Save** button. The content will be saved successfully, and a text note icon will appear in the top left corner of the image.

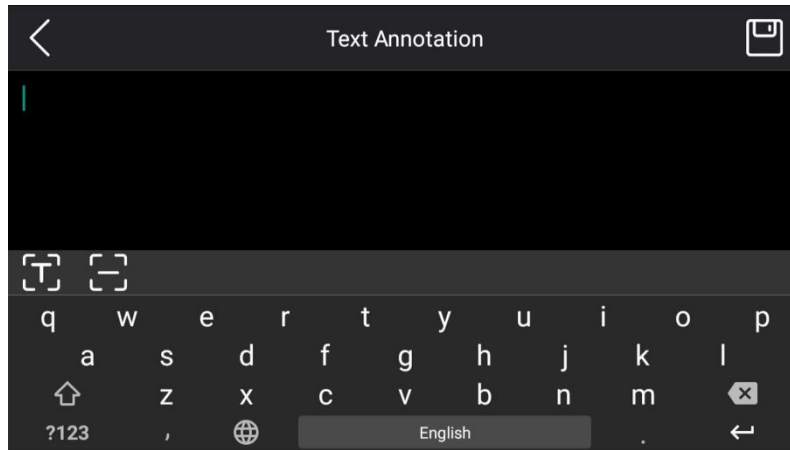

The voice note function on the device may vary depending on the specific model. Please refer to the actual device.

## 8. Tag Table

Here is the English translation of the provided instructions:

Each row in the label table can be entered through a dropdown list or soft keyboard input, saved to a file, and then filtered by label values in the gallery. The specific steps are as follows:

1. Freeze the screen/gallery preview, press the OK button or touch the main menu to bring up the device menu.
2. **Device menu** → **Tag Table**

Default	
Location	▼
Sub-location	▼
Target	▼
Target ID	▼
Inspected	▼

- As shown in the image, the left side represents the field name, and the right side represents the field value. The field value can be selected from a dropdown list or entered as text. For example, in the image, select the dropdown option "Company A," then change it to "Company AA." Afterward, click the button to add "Company AA" to the dropdown options.

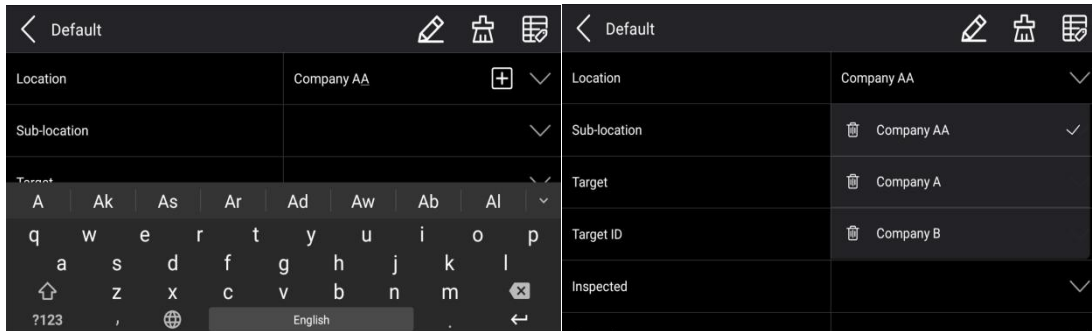

- Press the back button and select "Save table" to complete the addition of the Tag table.



Function: Clicking this button will enable editing field names, allowing the user to add, modify, and delete them. After editing, click the button again to save the changes.

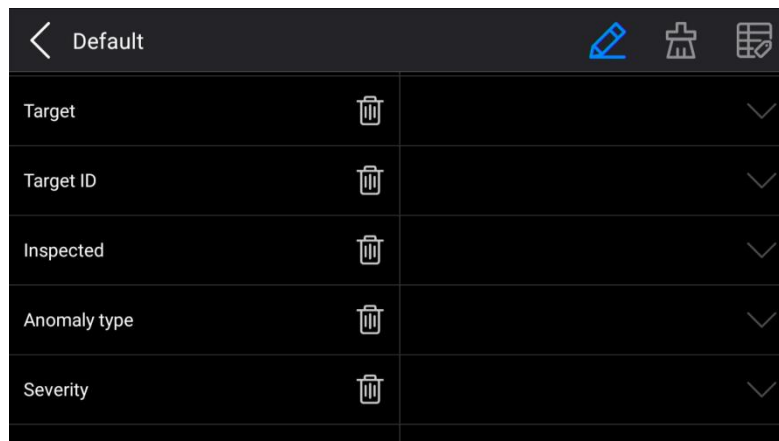

Function: Clicking this button will clear all field values.



Function: Clicking this button allows you to switch between different table templates. To do this, create a new folder called "TagTable" on the device's storage card, and import the custom label templates from the PC software. Then, the user can select different table templates on the device.

- Default** is the default label table that comes with the device.
- Tag Template 1** is a user-customized label template.

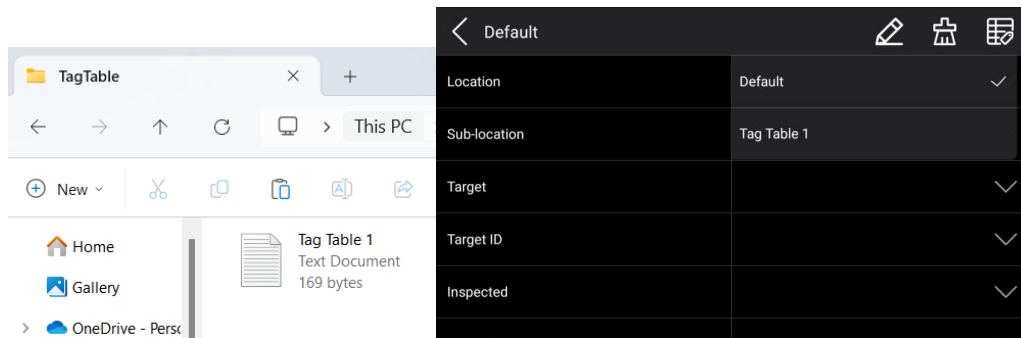

**Sorting Function:** When you press and hold a row, the following status will appear, allowing you to drag it to a suitable position above or below for sorting.

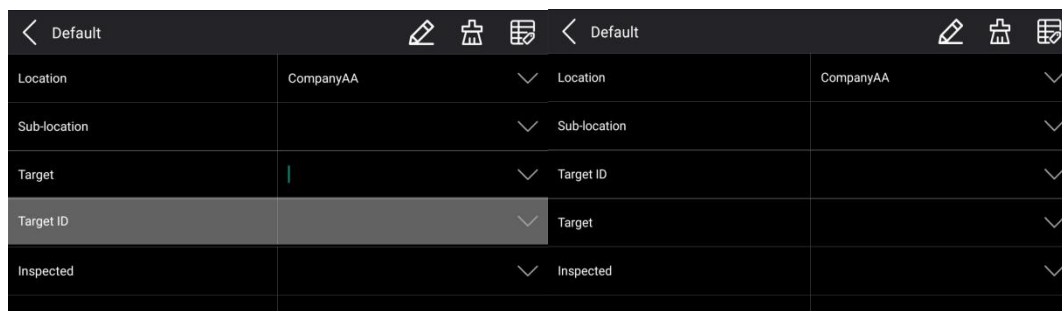

The label function on the device depends on the specific model; please refer to the actual device for details.

## 9. Favorites

### Operation Steps:

1. Freeze the screen/gallery preview, press the OK button or touch the main menu to bring up the device menu.
2. **Device menu** → **Favorites**
3. Press the OK button or touch the favorite icon, and the favorite icon will appear in the top-left corner of the image.

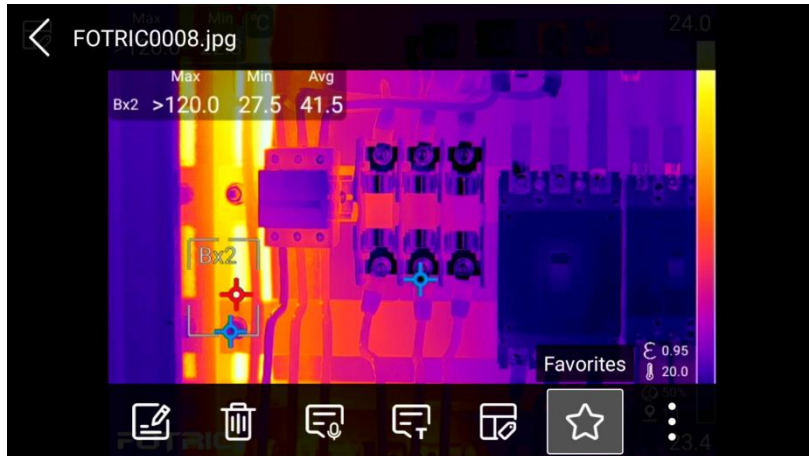

## NOTE

The collection function on the device depends on the specific model; please refer to the actual device for details.

## 10. Sketch

Make sketched by dragging your finger on the display screen and save it to the thermal image.

### Operation steps:

1. Enter the sketch interface through the Add after saving/Gallery preview interface...;
2. Select the graffiti pen of the corresponding color as needed to draw;
3. Select the eraser to erase the excess graffiti part, click the Save button, and the sketch is successfully saved to the thermal image.

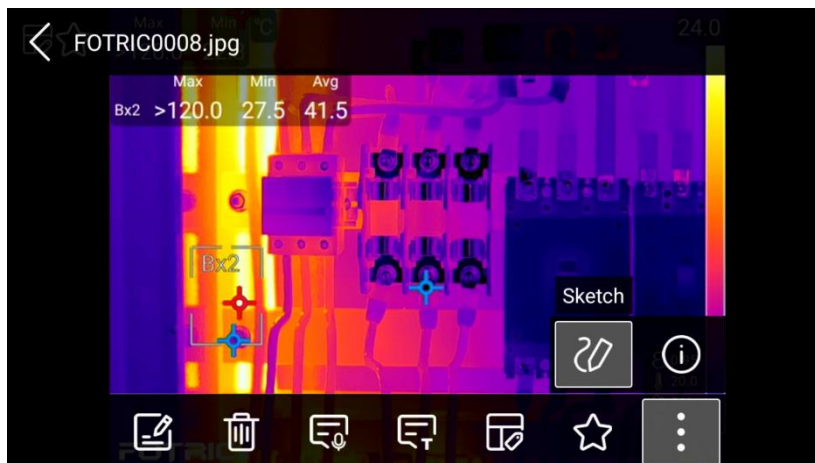

## 11. Gallery

The files are saved on the SD storage card, and the user can view all the saved files through the gallery.

### Operation Steps:

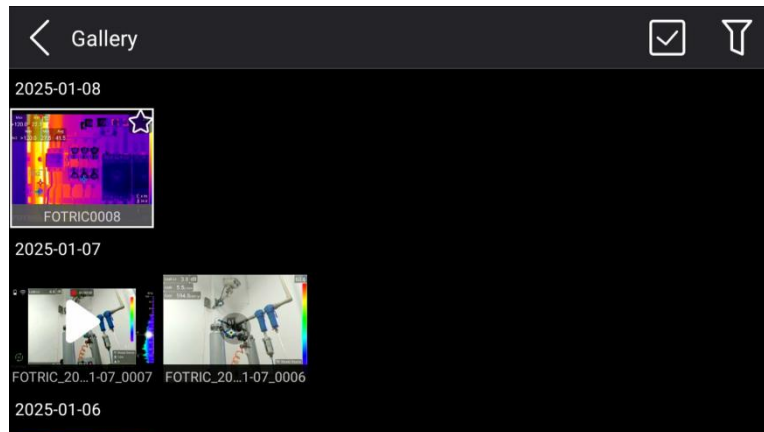

1. Press the Gallery button on the device to enter the gallery interface.

- 
2. Press the Back button on the device to return to the live view interface.



## Generate Report: 9.12 On-device Report

### Delete

- Click the selection icon /button at the top of the gallery, or press the selection icon  at the top and then press the OK button.
- Select one or more files, then click the delete icon/button at the top of the gallery, or press the delete icon at the top and then press the OK button.
- Click the confirm button to successfully delete the selected files

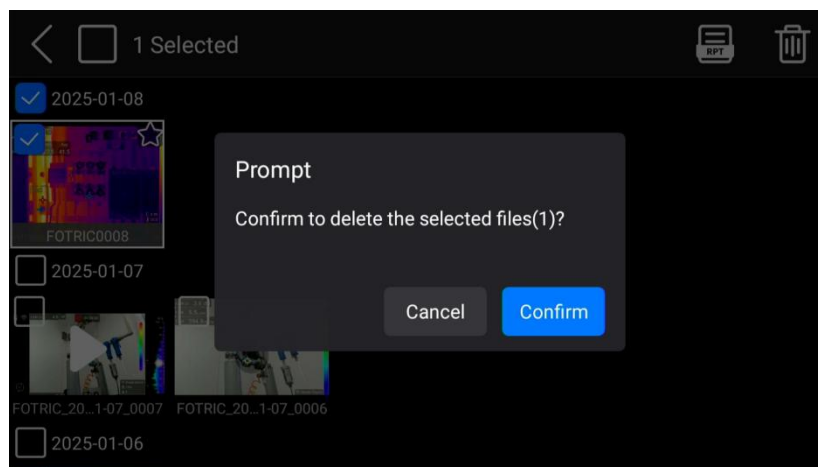

### Filtering

- Click the filter icon/button at the top of the gallery, or press the filter icon at the top and then press the OK button.
- Select "Favorites" to successfully filter out the files marked as favorites.
- Select "IR" to successfully filter out the files taken with the thermal imager.
- Select "AC" to successfully filter out the files taken with the thermal imager.
- Select a specific tag to successfully filter out the files with that tag.

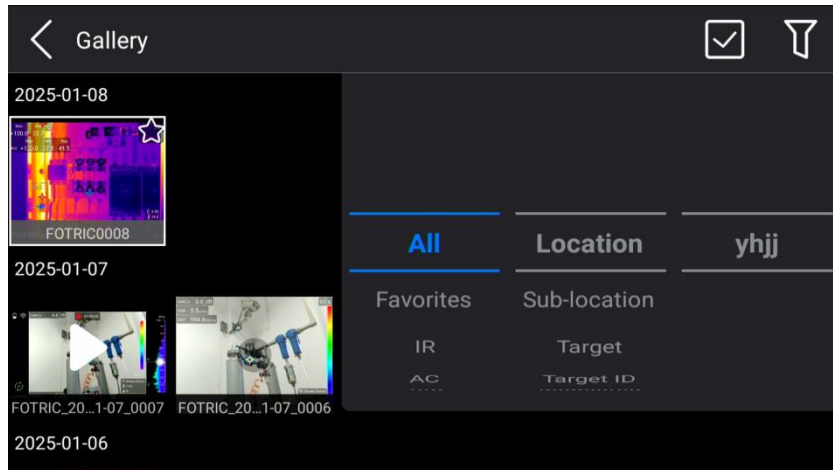

**Gallery Preview**

The thermal image has been selected. Touch the thermal image or press the OK button to enter the gallery preview interface



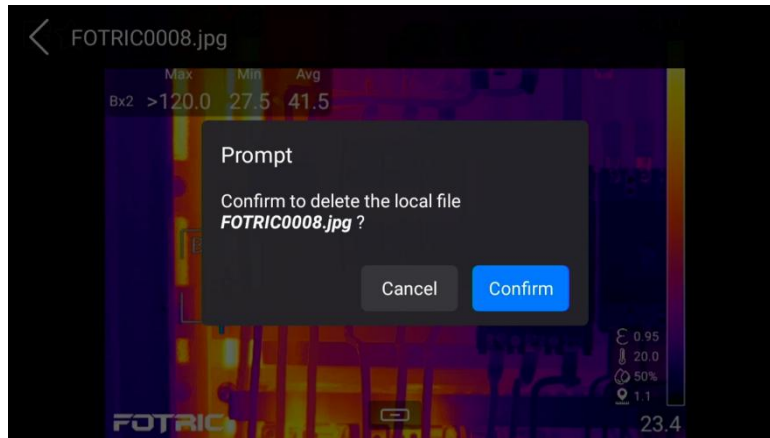

**Delete Function:**

Click the delete button, and the image or video will be successfully deleted



 Voice Annotation: 9.3. Voice Annotation.

 Text Annotation: 9.4 Text Annotation.

 Tag Table: 9.5 Tag Table

 Favorites: 9.6 Favorites

## 12. On-device Report

Support the generation of Word or PDF reports from single or multiple thermal images.

Operating Steps:

1. Click the selection icon above the gallery  / Press the key to directly reach the selection icon

 above, then press the OK key;

2. Select one or more thermal images, click the 'Generate Report' icon above the gallery / Press the key to directly reach the 'Generate Report' icon above, then press the OK key;

3. Select the report format: docx, tap / press the OK key to successfully generate a .docx report for the selected thermal image.;

4. Select the report format: pdf, tap / press the OK key to successfully generate a .pdf report for the selected thermal image.

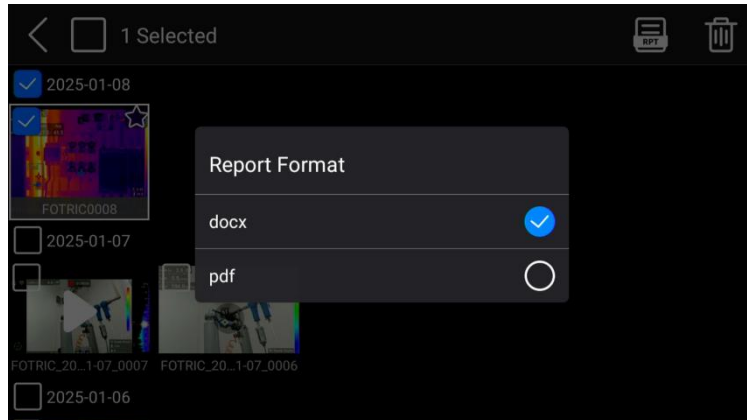

The built-in report function on the device may vary depending on the specific model. Please refer to the actual device.

## 10.Plug-ins

### 1. MagicThermal®

AI recognizes the target feature area, and uses the temperature measurement box (which fits the contours of the target feature area) to select the region, saving the temperature measurement box information to the thermal image. The temperature measurement box cannot be moved or fine-tuned on the device, but it can be edited using PC analysis software. The specific steps are as follows:

1. In the live view interface, press the OK key / touch the main menu to bring up the device menu.
2. **Device menu** → **Settings** → **Plugin Management** → **Enable MagicThermal® plugin.**
3. Return to the live screen, freeze the image, tap the magic wand icon  in ROIs, select the target object, and use the temperature measurement box (to fit the contours of the target feature area) to select the region.

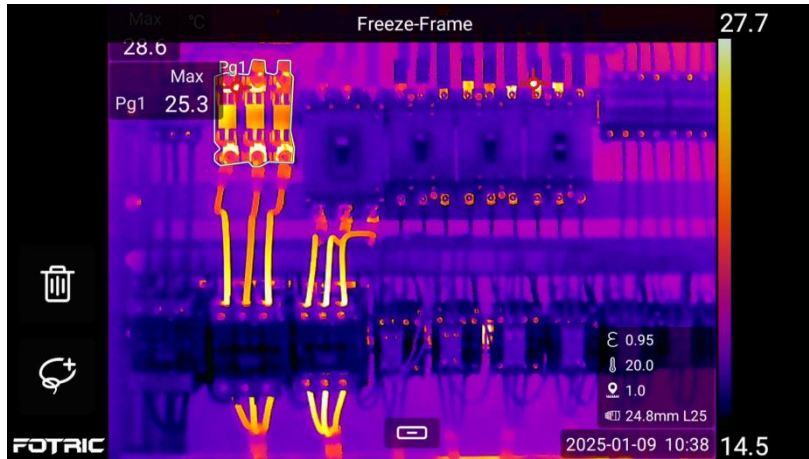

## 2. NaviPdM Venus

For detailed instructions, please refer to the user manual of this featured function

# 11.Connection

## 1. WiFi Connection

Use Wi-Fi to connect the device to a wireless local area network (WLAN).

### Steps:

1. On the main menu interface, press the OK button or tap the main menu to bring up the device menu.
2. Go to **Device Menu** → **Settings** → **Connection** → **WLAN**.
3. Enable the wireless network, which will display a list of available networks. Select a network.
4. Choose one of the available networks. Networks with password protection will be indicated by a padlock icon. To access these networks, enter the password and click the "**Join**" button. The wireless network will be successfully connected.

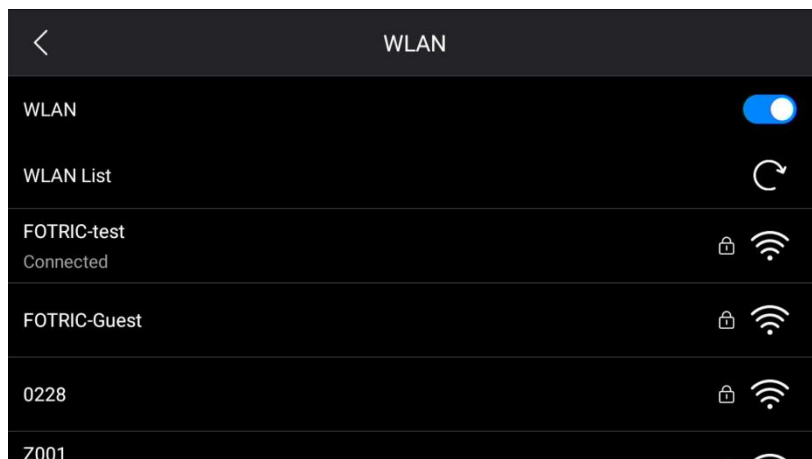



The Wi-Fi connection function on the device depends on the specific model. Please refer to the actual device for details.

## 2. Bluetooth

### Bluetooth Connection

After enabling Bluetooth, the user can search for nearby Bluetooth headphones for pairing. Once paired successfully, the user can listen to the recorded voice in the thermal image and radiometric video through the Bluetooth headphones.

#### Steps:

1. On the main menu interface, press the OK button or tap the main menu to bring up the device menu.
2. Go to **Device Menu** → **Settings** → **Connection** → **Bluetooth**.
3. Enable Bluetooth connection, which will display a list of available Bluetooth headphones.
4. Select an available Bluetooth headphone to connect. Once the Bluetooth connection is successful, the status will change to "Connected."

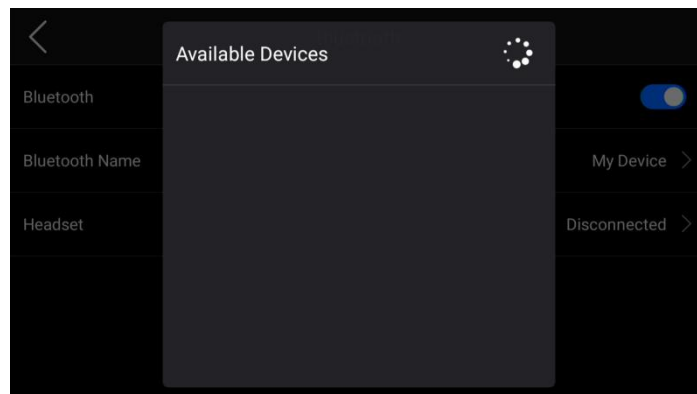

- Bluetooth connection function depends on the specific model. Refer to the actual device for details.
- After adding a Bluetooth headphone, it can be used to add voice annotations.
- Once a Bluetooth headphone is added, the built-in microphone and speaker are automatically disabled.

## 3. USB Interface

### USB Interface

The device can be connected to a computer using a USB cable. Once the connection

---

is established, image and video files can be transferred from the storage card to the computer.

### USB Mode:

1. Open the interface box cover and connect the USB cable to the USB Type-C interface in the connector cover. Connect the other end of the USB cable to the computer.
2. On the main menu interface, press the OK button or tap the main menu to bring up the device menu.
3. Go to **Device Menu** → **Settings** → **Device Set** → **USB Mode: AC**. The device has not yet established a connection with the computer

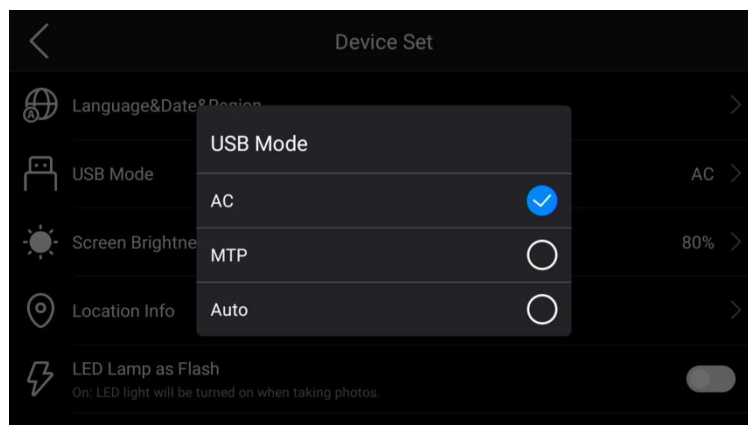

### USB Mode: File Transfer (MTP)

1. Open the cover of the device interface box and connect the USB cable to the USB Type-C interface in the connector cover. Then, connect the other end of the USB cable to the computer.
2. On the main menu interface, press the OK button or tap the main menu to bring up the device menu.
3. **Device menu** → **Settings** → **Device Settings** → **USB Mode Selection: File Transfer (MTP)**, the device successfully establishes a connection with the computer.
4. On the computer, open the SD card's Gallery folder, and use drag-and-drop to move the desired files to the computer.
5. Import the images into the computer analysis software for further analysis.

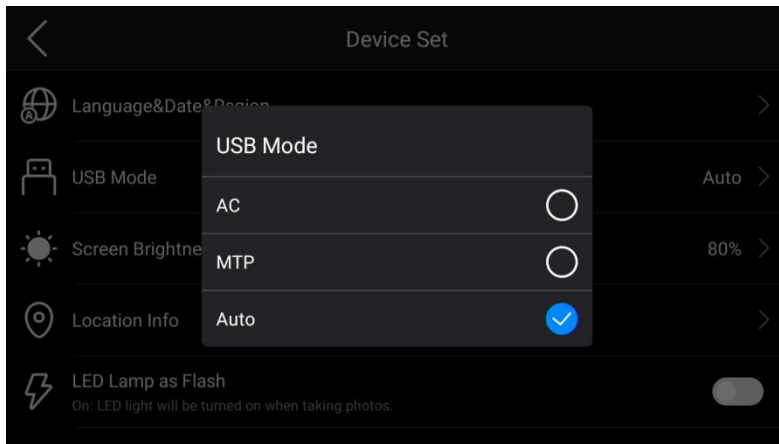

### USB Mode: Auto

1. Open the cover of the device interface box and connect the USB cable to the USB Type-C interface in the connector cover. Then, connect the other end of the USB cable to the computer.
2. On the main menu interface, press the OK button or tap the main menu to bring up the device menu.
3. **Device menu → Settings → Device Set → USB Mode Selection: Auto.**
4. When the device is powered on, a prompt will appear: "USB cable detected. Do you want to switch to file transfer (MTP) mode?"
5. Confirm: Successfully switched to file transfer (MTP) mode, and the device successfully establishes a connection with the computer.

Cancel: Did not switch to file transfer (MTP) mode, and the device did not establish a connection with the computer.

## 4. HDMI Interface

Use the device-compatible HDMI cable to connect the device to the computer. The device's interface image will be synchronized and displayed on the computer screen.

## 5. FTP

Connect to the device via WiFi network or the device's own WiFi hotspot, then access the data on the device through FTP.

### Operation steps:

1. On the main menu interface, press the OK button or tap the main menu to bring up the device menu.
2. **Device menu → Settings → Connection → More Connection → FTP .**
3. Enable FTP Quick Transfer, and use a client browser, file manager, or FTP client tool to enter the FTP address: ftp://IP:port/ to connect to the thermal imaging device's FTP service and perform file transfer.

- 
4. The user can configure whether to allow anonymous access. If anonymous access is enabled, the client does not need to authenticate and can connect to the device's FTP service to operate the file system.
  5. If anonymous access is disabled, the client needs to enter the configured username and password to access the file system.

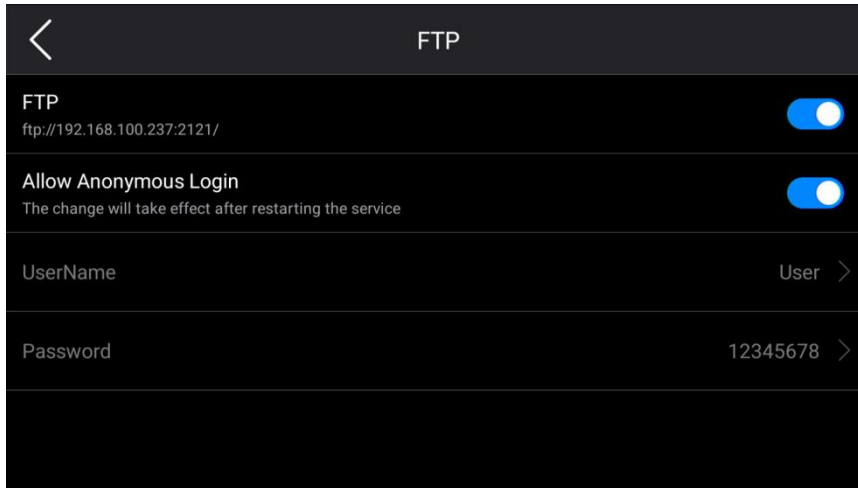

#### NOTE

- The FTP quick transfer function on the device depends on the specific model. Please refer to the actual device for details.
- In WLAN mode, the client must connect to the same WLAN network.
- In hotspot mode, the client must first connect to the device's hotspot before it can be accessed

## 6. PC Radiometric Video Stream

PC radiometric video stream can be analyzed in real-time through AnalyzIR. For specific operation steps, please refer to the user manual of the analysis software.

## 7. Remote Display

Radiometric video stream can be viewed via the USB Type-C interface connected to AnalyzIR, while the HDMI interface can be used to connect to a display or projector. For detailed instructions, please refer to the corresponding user manual.

## 12. Remote Control

---

## 1. PC Control

AnalyzIR supports installation on Windows systems, allowing you to connect devices for real-time data analysis and view and analyze the captured and recorded data. For detailed instructions, please refer to the user manual of the analysis software.



The desktop control functionality depends on the specific model. Please refer to the actual device for details.

## 2. Mobile Device Control

The mobile software EasyIR is available on Android systems, allowing users to preview the device's screen, synchronize device data, and view, browse, share, and analyze the synchronized data. For detailed instructions, please refer to the user manual for the mobile app.

## 3. Webpage Control

Remote operation control can be performed through the browser of devices such as mobile phones, computers, and tablets, allowing you to access, analyze, and share local data. For detailed instructions on the web-based control, please refer to the user manual for the web interface.

The device's IRExplorer page displays the web link, editable username, password, and the scanned QR code.

### Steps:

- Press the OK button or tap the main menu to bring up the device menu.
- **Device menu → Settings → Connections → More Connections → IRExplorer.**
- Enter the IP address on a computer or mobile device to access the IRExplorer login page.
- Log in using a username and password, or directly access the login page by scanning the QR code.



The availability of web-based control varies by model.

# 13. Auxiliary Functions

## 1. Intelligent Focusing System (TurboFocus®)

The intelligent focusing system supports Contrast Thermal Focus, Laser Focus, Continuous Autofocus, and Touch Screen Focus.

### Contrast Thermal Focus:

- 
- In the main menu interface, press the OK button or tap the main menu to bring up the device menu.
  - **Device menu** → **Settings** → **IR Device Set** → **TurboFocus®** → **Select Contrast Thermal Focus** for autofocus.
  - Return to the main menu interface, press the focus button to perform autofocus based on the optimal contrast of the image.

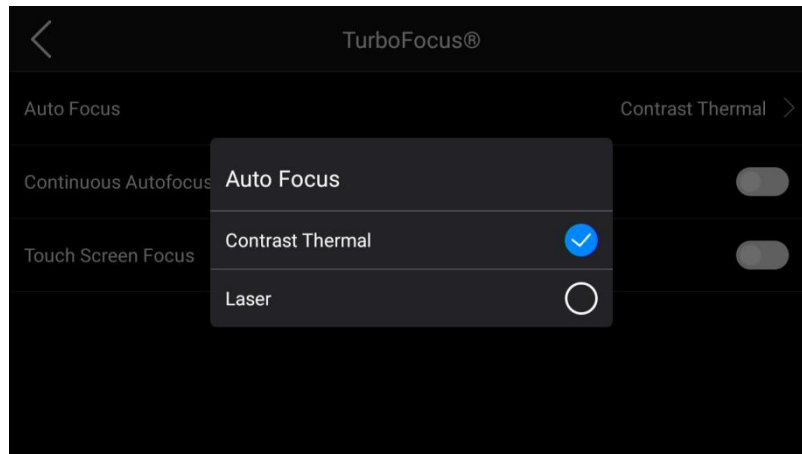

#### **Laser Focus:**

- In the main menu interface, press the OK key or touch the main menu to bring up the device menu.
- **Device menu** → **Settings** → **IR Device Set** → **TurboFocus®** → **Select Laser Focus** for automatic focus.
- Return to the main menu interface, press the focus button, and the automatic focus will be performed based on the distance between the measurement imager and the target.

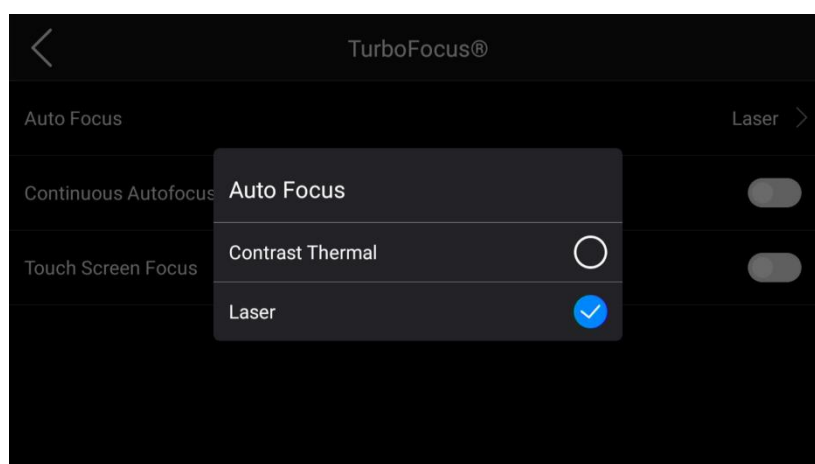

#### **Continuous Autofocus:**

- In the main menu interface, press the OK key or touch the main menu to bring up the device menu.
- **Device menu** → **Settings** → **IR Device Set** → **TurboFocus®** → **Enable Continuous Autofocus**.

---

· Return to the main menu interface. After the device moves and then stops, the continuous automatic focus adjustment will be performed based on the Thermal contrast or laser distance measurement method, depending on the different distances of the measured objects in the scene.



The **TurboFocus®** intelligent focusing system on the device is dependent on the specific model. Please refer to the actual device for details.

#### **Touch Screen Focus**

- In the main menu interface, press the OK key or touch the main menu to bring up the device menu.
- **Device menu** → **Settings** → **IR Device Set** → **TurboFocus®** → Enable **Continuous Autofocus**.
- Return to the main menu interface. After the device moves and then stops, the continuous automatic focus adjustment will be performed based on the image contrast or laser distance measurement method, depending on the different distances of the measured objects in the scene.

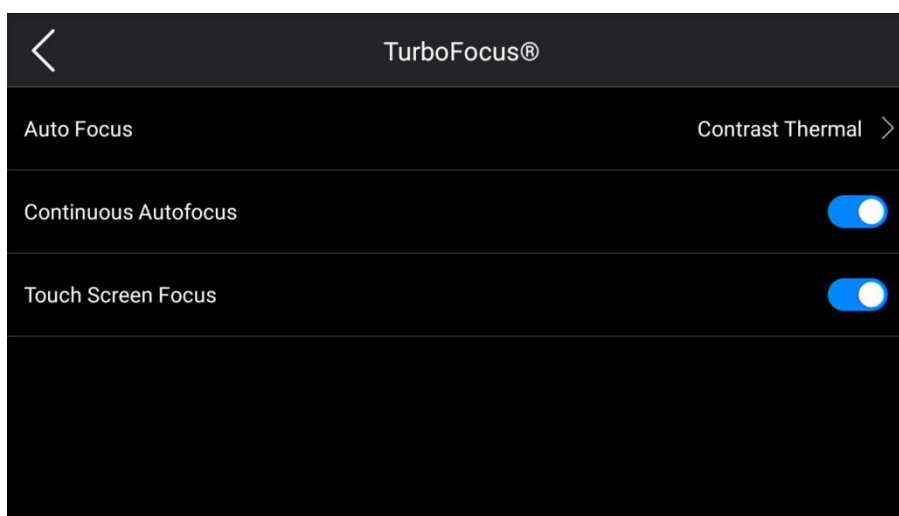



The touch focus function on the device is available depending on the specific model. Please refer to the actual device for confirmation

## 2. Floating Ball

The floating ball enables virtual button functions to call up features such as photo capture, lighting, AI, and gallery physical buttons.

### Steps:

1. On the live interface, press the OK button or tap the main menu to bring up the device menu.
2. **Device menu → Settings → Device Set → Floating Ball.**
3. After enabling, the floating ball button will appear on the live interface and can be moved to any position.
4. Tap the floating ball button to expand the sub-functions. Tap again to collapse the sub-functions of the floating ball.

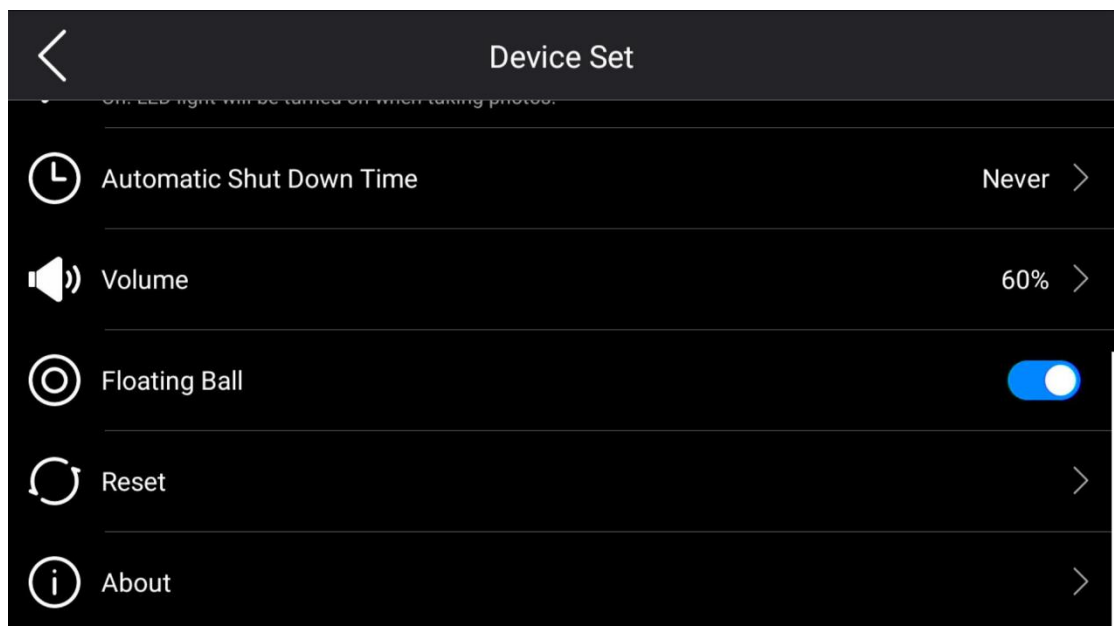

## 3. Laser

Supports **Laser Pointer** and **Laser Distance Measurement**.

### Operation Steps:

1. Press the laser button on the device to turn on the laser.

2. A laser point will be visible on the target, and the screen will display the symbol  along with the laser measurement distance.
3. Release the laser button to turn off the laser.



#### NOTE

The laser distance measurement function on the device is available depending on the specific model. Please refer to the actual device for confirmation.

## 4. Region Feature Measurement

Support temperature measurement along the measurement line length and support temperature measurement for rectangular and circular areas.

### Temperature Line Length Measurement:

1. Add a temperature measurement line on the real-time screen.
2. Ensure the temperature measurement line is centered on the image.
3. Adjust the length of the temperature measurement line to match the size of the target.
4. Keep the device perpendicular to the target and press the laser button on the device.
5. The calculated length will be displayed on the real-time screen.

### Temperature Frame Rectangle and Circle Area Measurement:

1. Add a temperature measurement frame rectangle and a temperature measurement frame circle on the real-time screen.
2. Ensure the temperature measurement frame rectangle or temperature measurement frame circle is centered on the image.
3. Adjust the size of the temperature measurement frame rectangle or temperature measurement frame circle to match the size of the target.
4. Keep the device perpendicular to the target and press the laser button on the device.
5. The calculated area will be displayed on the real-time screen.



### NOTE

The region feature measurement function on the device depends on the specific model. Please refer to the actual device for details

## 5. GPS

Supports GPS satellite positioning.

### Operation Steps:

1. On the main menu interface, press the OK button/tap the main menu to bring up the device menu.
2. Device menu → Settings → Device Settings → Location Information → Geolocation.
3. Turn on Geolocation, and location information can be saved to a file.

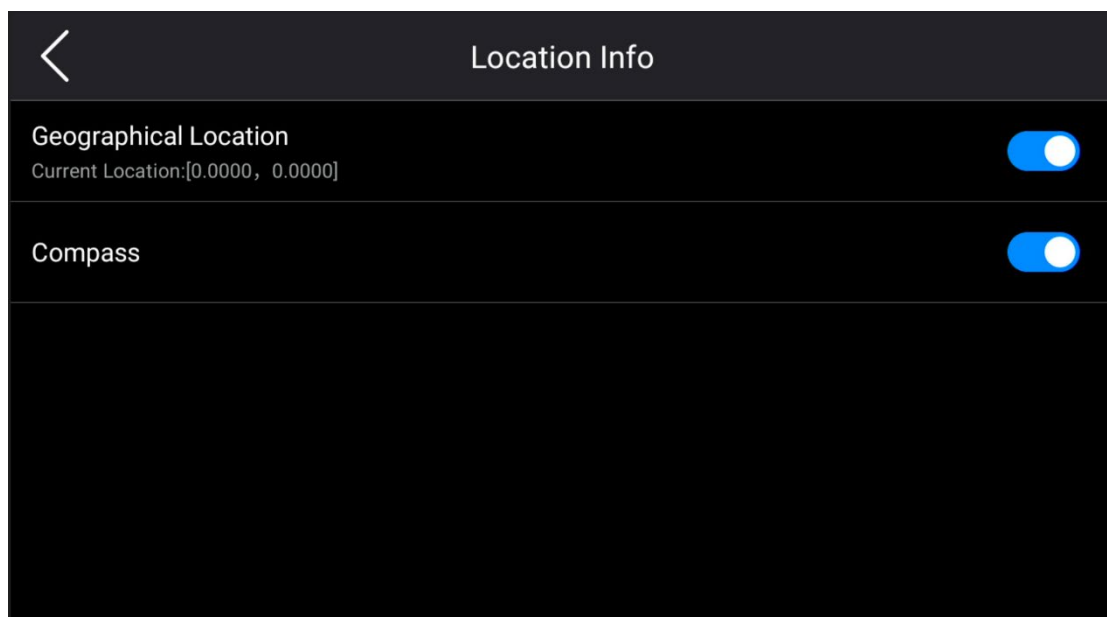



**NOTE**

The geolocation function on the device depends on the specific model. Please refer to the actual device.

## 6. Compass

Support 360° orientation

Operation steps:

1. In the main menu interface, press the OK button or touch the main menu to bring up the device menu.
2. **Device menu → Settings → Device Settings → Location Information → Compass.**
3. Turn on the compass, and the orientation information can be saved to the thermal image and radiometric video.
4. **Device menu → Settings → Thermal Image Settings → Image Overlay Information → Enable Compass.**
5. Return to the main menu interface, and the orientation information will be displayed in the image overlay section at the bottom right of the main menu interface.

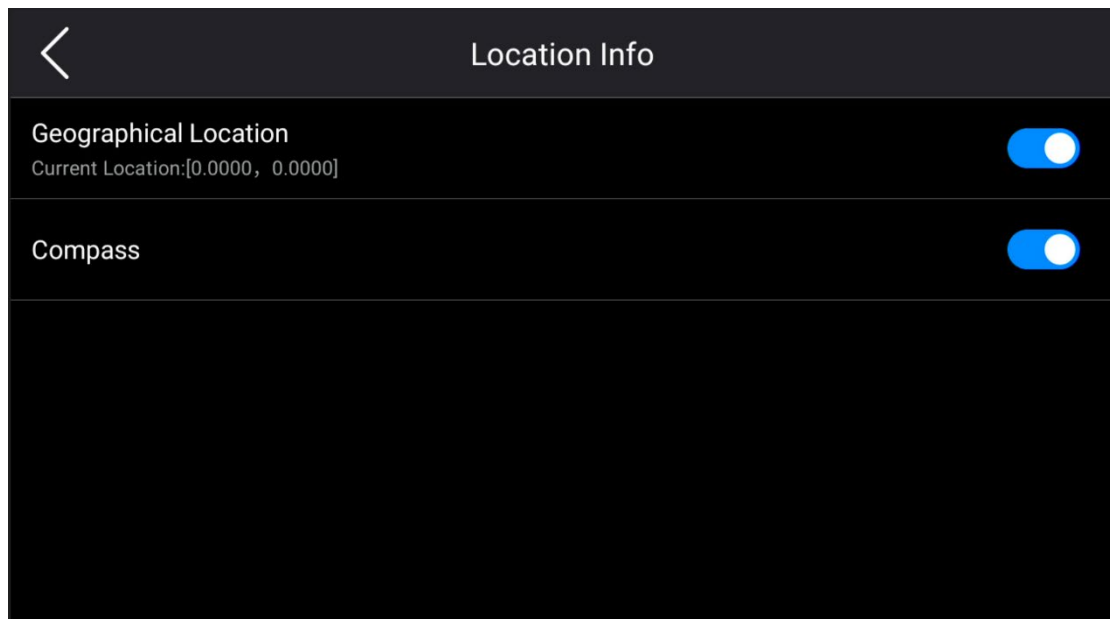

## 7. LED Lamp

Support for **Flashlight illumination** and **Flash mode**.

**Flashlight Illumination:**

Open the device's flashlight from the main menu interface drop-down menu and use it as a flashlight.

**Flash Mode:**

1. In the main menu interface, press the OK button or touch the main menu to bring up the device menu.
2. **Device menu → Settings → Device Settings → LED light as flash.**
3. Once enabled, the LED light will function as a flash when pressing the shutter button for single-frame capture, or the LED light will continuously function as a flash during timed continuous capture for image saving.

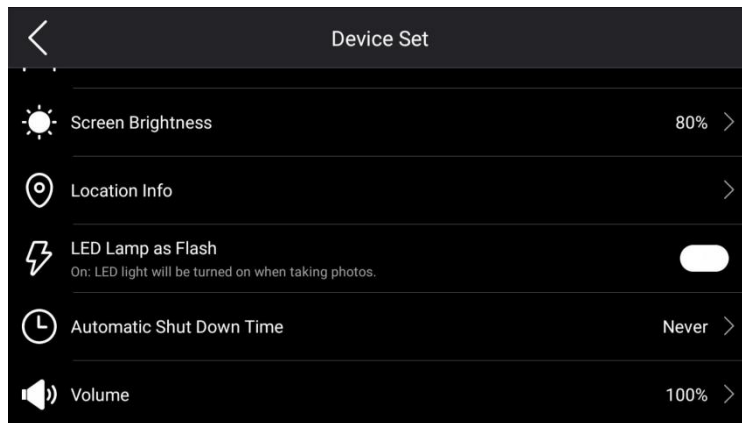

## 8. Language

The supported languages include: Simplified Chinese, English, Traditional Chinese, Spanish, Korean, German, Portuguese, Italian, French, and Thai.

Operation steps:

1. In the main menu interface, press the OK button or touch the main menu to bring up the device menu.
2. **Device menu → Settings → Device Settings → Language&Time&Region → Language.**
3. The default languages are Simplified Chinese and English. Select a language to switch to that language.

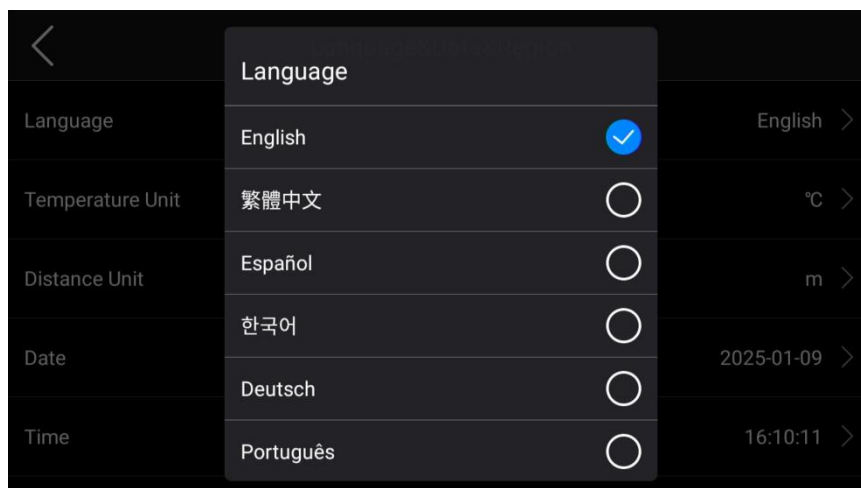



#### NOTE

The default language on the device depends on the specific model. Please refer to the actual device for confirmation.

## 9. Software and Firmware Upgrades

Supports online software upgrades, offline upgrades, and system configuration online and offline upgrades.

### Online Software Upgrade:

1. On the main menu interface, press the OK button/touch the main menu to bring up the device menu.
2. **Device Menu** → **Settings** → **Device Set** → **About** → **System Update**.
3. Ensure WIFI is enabled, the device is connected, and the network is stable.
4. Agree to the user agreement and click "Software Update."
5. Click "**Online Upgrade**," and the available upgrade version will be detected.
6. Click the upgrade button, and the system will proceed with the upgrade. After the upgrade is complete, the device will restart, and the software version will be updated to the successfully upgraded version.



### Offline Software Upgrade:

- The upgrade package (.epk file) has been placed in the device's storage card in the corresponding "update" folder.
- On the main menu interface, press the OK button/touch the main menu to bring up the device menu.
- **Device Menu** → **Settings** → **Device Set** → **About** → **System Update**
- Agree to the user agreement and click "**System update**."
- Click "**SD Update**," and a QR code scanning interface will appear.

- 
- Use smartphone to scan the QR code. After the upgrade verification is successful, a verification code will be displayed. Enter the code in the device's QR code interface to proceed with the upgrade. Once the upgrade is completed, the device will restart, and the software version will be updated to the successfully upgraded version.

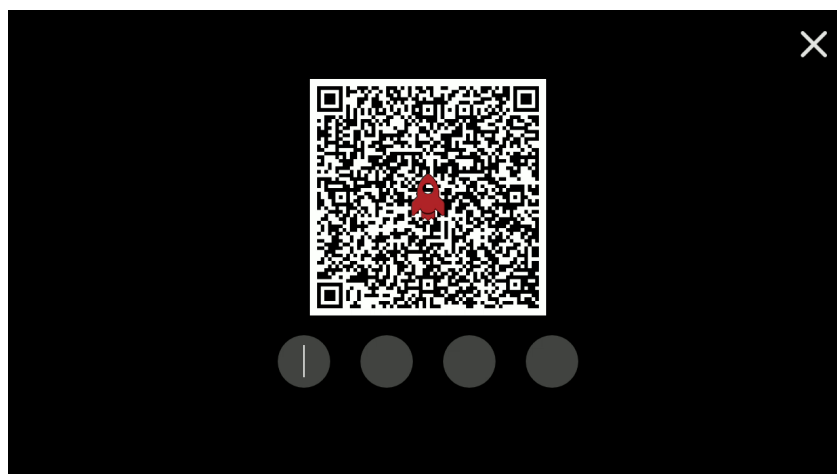

### **Online System Configuration Upgrade:**

- Ensure WIFI is enabled, the device is connected, and the network is stable.
- On the main menu interface, press the OK button/touch the main menu to bring up the device menu.
- Device Menu → Settings → Device Set → About → System Update.
- Agree to the user agreement and click "System Configuration Upgrade."
- Click "Online Update," and the available upgrade version will be detected.
- Click the upgrade button, and the system will proceed with the upgrade. After the upgrade is complete, the device will restart, and the system configuration version will be updated to the successfully upgraded version.



### Offline System Configuration Upgrade:

- The upgrade package (.epk file) has been placed in the device's storage card in the corresponding "update" folder.
- On the main menu interface, press the OK button/touch the main menu to bring up the device menu.
- Device Menu → Settings → Device Settings → Device Information → System Upgrade.
- Agree to the user agreement and click "System Configuration Upgrade."
- Click "SD Update" and a QR code scanning interface will appear.
- Use a smartphone to scan the QR code. After the upgrade verification is successful, a verification code will be displayed. Enter the code in the device's QR code interface to proceed with the upgrade. Once the upgrade is completed, the device will restart, and the device configuration version will be updated to the successfully upgraded version.



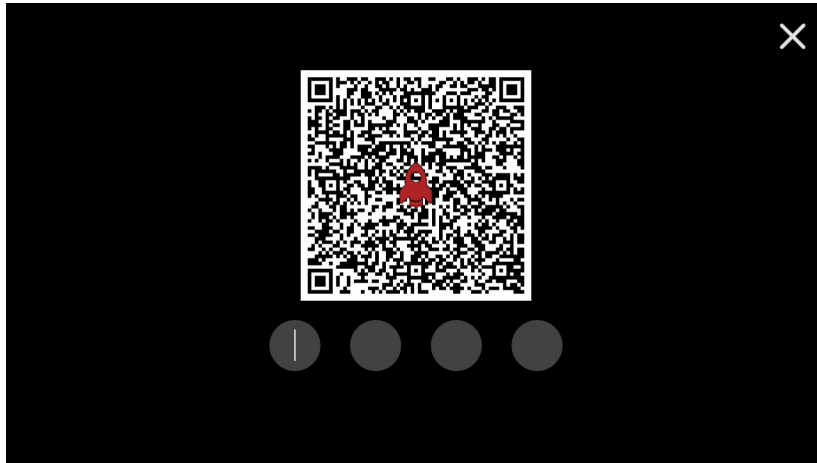

## 10. Device Set

Set the language, time, and region, USB mode, screen brightness, location information, LED light as flashlight, auto shutdown time, volume, reset, and view device information.

**Language&Time&Region Settings:** Set language, Temperature Unit, Distance Unit, Date, Time, Time Zone, and Date Format.

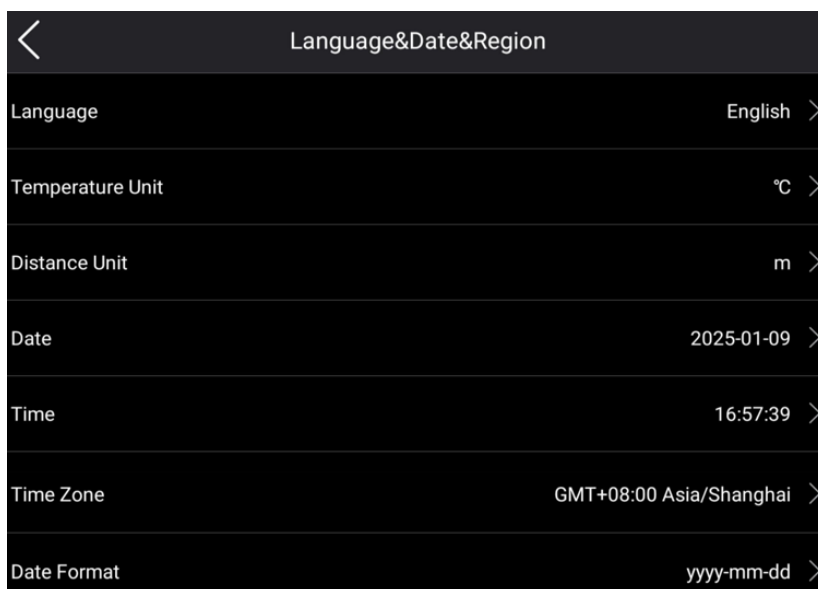

**Language Setting:** Refer to section 12.8 Supported Languages.

**Set Temperature Unit:**

1. On the main menu interface, press the OK button/touch the main menu to bring up the device menu.
2. **Device Menu** → **Settings** → **Device Set** → **Language&Time&Region** → **Temperature Unit**.
3. Set the temperature unit parameter.

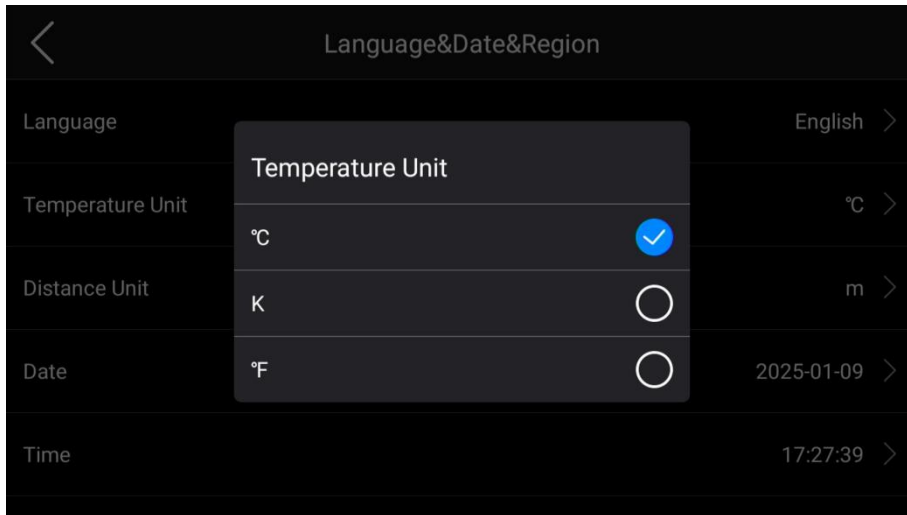

### Set Distance Unit:

1. On the main menu interface, press the OK button/touch the main menu to bring up the device menu.
2. **Device Menu** → **Settings** → **Device Set** → **Language&Time&and Region** → **Distance Unit**.
3. Set the distance unit parameter.

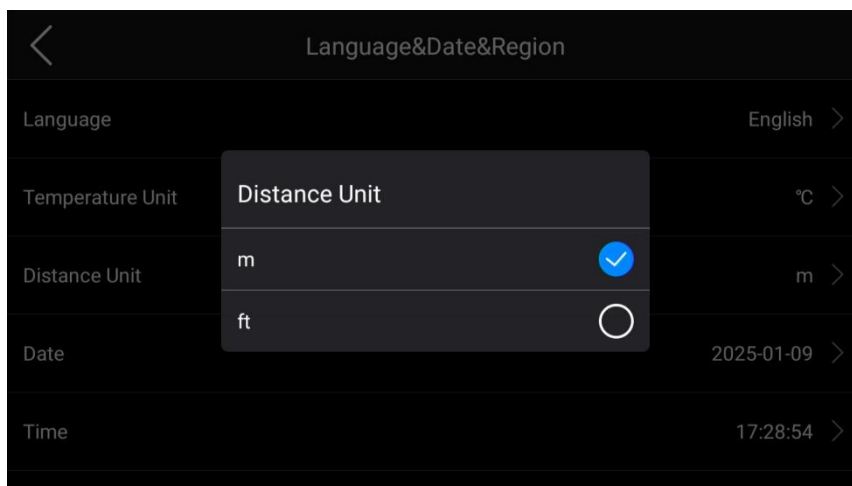

### Set Date:

1. On the main menu interface, press the OK button/touch the main menu to bring up the device menu.
2. **Device Menu** → **Settings** → **Device Set** → **Language&Time&Region** → **Date**

3. Set the date parameter.

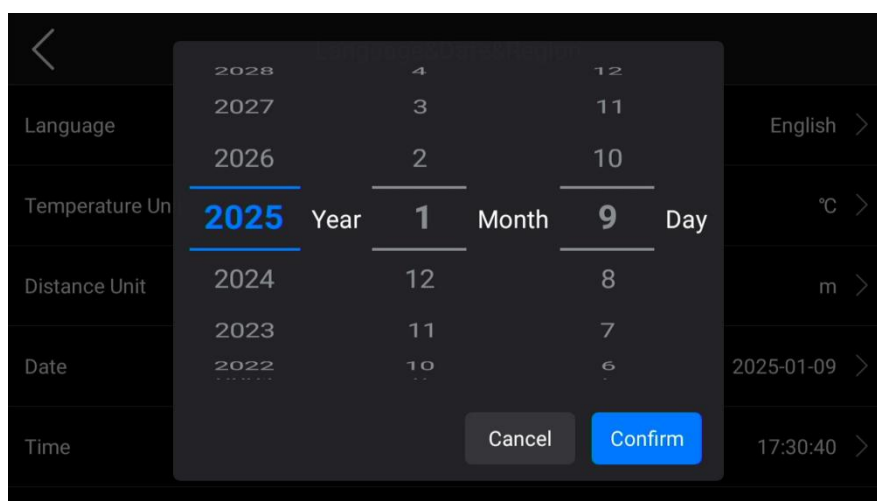

### Set Time:

1. On the main menu interface, press the OK button/touch the main menu to bring up the device menu.
2. **Device Menu** → **Settings** → **Device Set** → **Language&Time&Region** → **Time**
3. Set the time parameter.

### Set Time zone:

1. On the main menu interface, press the OK button/touch the main menu to bring up the device menu.
2. **Device Menu** → **Settings** → **Device Set** → **Language&Time&Region** → **Time zone**.
3. Set the time zone parameter

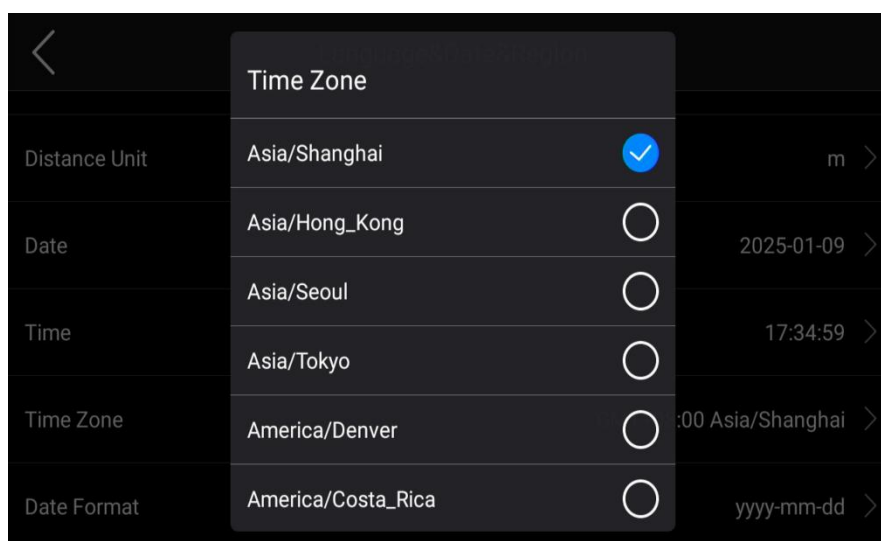

### Set Date Format:

1. On the main menu interface, press the OK button/touch the main menu to bring up the device menu.
2. **Device Menu → Settings → Device Set → Language&Time&Region → Date Format.**
3. Set the date format parameter.

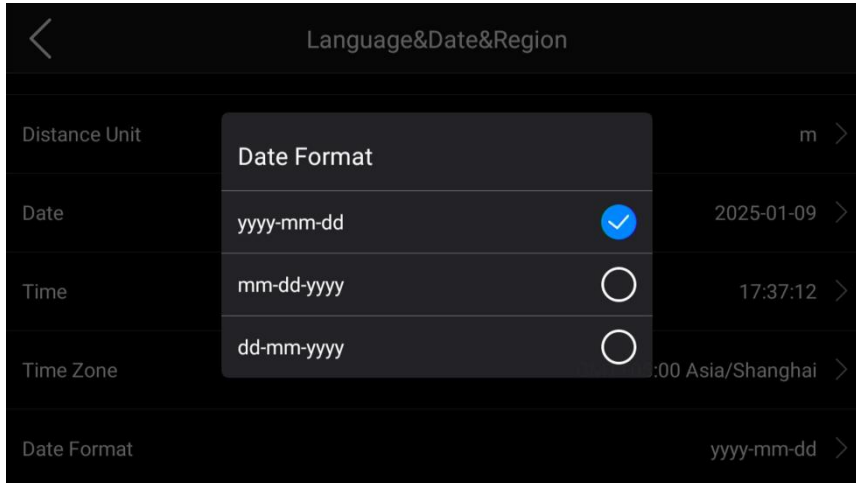

### Screen Brightness:

1. On the main menu interface, press the OK button/touch the main menu to bring up the device menu.
2. **Device Menu → Settings → Device Set → Screen Brightness.**
3. Slide the screen or press the left/right buttons to adjust the screen brightness.

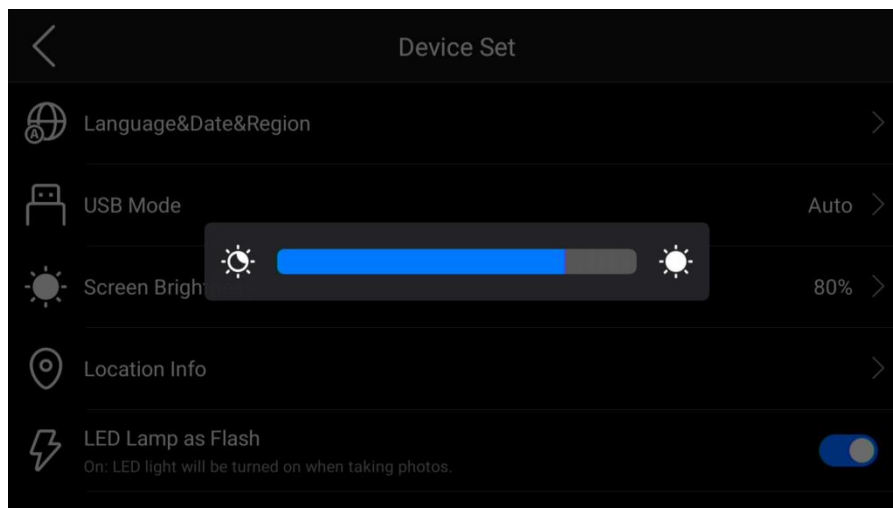

### Location Information:

Refer to 13.6 Compass

### LED as Flashlight:

Refer to 13.7 LED Lamp

---

## Auto Shutdown Time:

1. On the main menu interface, press the OK button/touch the main menu to bring up the device menu.
2. **Device Menu → Settings → Device Set → Automatic Shutdown Time.**
3. Set the auto shutdown time, which specifies how long the device will stay on after inactivity before automatically shutting down.

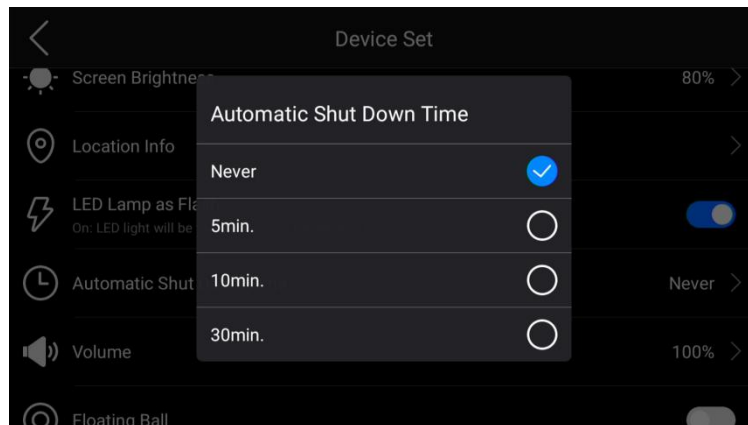

## Volume:

1. On the main menu interface, press the OK button/touch the main menu to bring up the device menu.
2. **Device Menu → Settings → Device Set → Volume.**

## Reset

Reset parameters to the factory default settings, or delete all saved files.

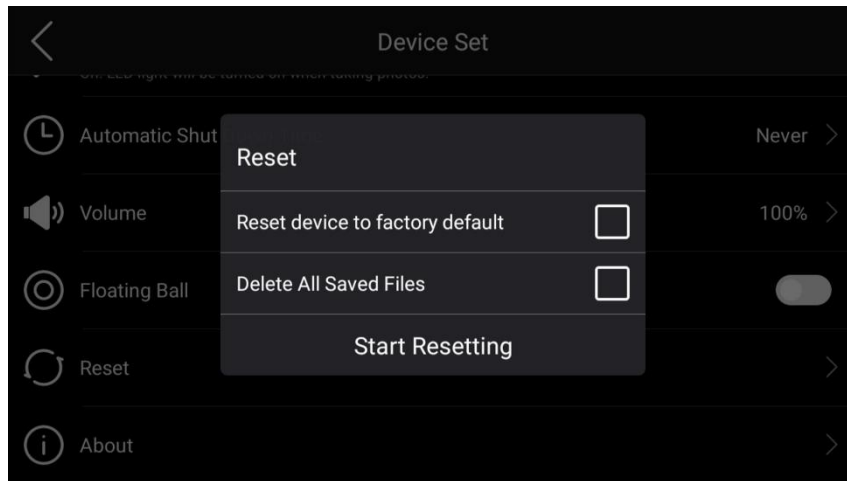

### Device Information

View model, serial number, application version, system version, lens, battery level, remaining SD storage capacity, status information (IMEI, IP address, MAC address, Bluetooth address), system update.

About	
Model	Fotric P7MiX
Serial Number	1001002892
App Version	6.8.0.6008924
System Version	1.2.0.89
AC Firmware	2.9.3.7
Microphone Channels	162
Battery Level	31%
Remaining SD Card Capacity	231.51GB
Status Information	>
System Update	>

## Appendix A. Emissivity table

(for reference only)

Material Name	Surface Condition	Temperature(°C)	Emissivity( $\epsilon$ )
Aluminum	Non-oxidized	100	0.20
	Oxidized	100	0.55
Brass	Polished brown	20	0.40
	Unpolished	38	0.22
	Oxidized	100	0.61
Copper	Severely oxidized	20	0.78
Iron	Oxidized	100	0.74
	Rusty	25	0.65
Cast iron	Oxidized	200	0.64
	Non-oxidized	100	0.21
Wrought iron	Roughened	25	0.94
	Polished	38	0.28
Nickel	Oxidized	200	0.37
Stainless steel	Oxidized	60	0.85
Steel	Oxidized at 800°C	200	0.79
Common brick	Surface	20	0.93
Concrete	Surface	20	0.92
Glass	Polished plate	20	0.94
Lacquer	White	100	0.92
	Natural color black	100	0.97
Carbon	Smoke black	25	0.95
	Candle soot	20	0.95
	Graphite rough surface	20	0.98
Paint	Average of 16 colors	100	0.94
Paper	White	20	0.93
Sand	Surface	20	0.90
Wood	Polished	20	0.90
Water	Distilled water	20	0.96
Skin	Human	32	0.98
Pottery	Fine	21	0.90
	Abrasive	21	0.93

## Appendix B. Leak Evaluation Parameters

Name	Meaning
Leak Correction Factor	A user-defined adjustment factor applied to compensate for differences between calculated and actual leak rates. This accounts for site-specific conditions such as system pressure, leak shape, and orifice geometry.
Currency	The currency used for cost calculations. This parameter is applied to energy and gas cost values and displayed in reports.
Energy Cost	The cost of electrical energy consumed by the compressor, expressed as currency per kilowatt-hour (Currency/kWh).
Gas Cost	The cost of the leaked gas per unit volume, expressed as currency per cubic meter or cubic foot (Currency/m <sup>3</sup> or Currency/ft <sup>3</sup> ).
Specific Power	The amount of power required by the compressor to maintain a given flow rate. This value is typically specified on the compressor nameplate. If unavailable, it can be calculated by dividing the nominal power by the rated flow rate.
Flow Rate Unit	The unit used to express airflow measurements. Available options include liters per minute (L/min) and cubic feet per minute (CFM). This setting is used in calculations and report display.
Run Time	The total number of hours per year that the inspected pipeline or system operates. This value is used to estimate annual energy loss and cost.