

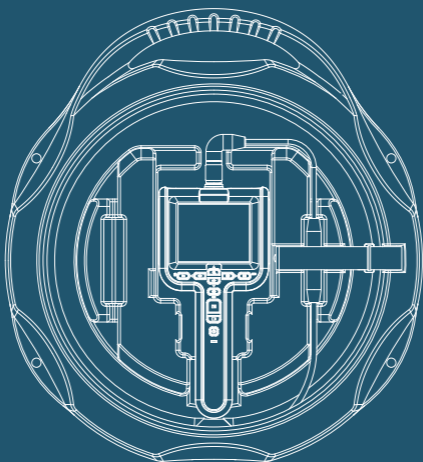

PS10HD

Industrial Videoscope



User Manual

Index

Safety & Cautions.....	2
1. Product Outlook.....	4
1.1 PS10HD.....	4
1.2 VF500.....	5
2. Getting started.....	6
3. Main functions.....	9
3.1 Multifunction keys.....	10
3.2 System mode.....	12
3.3  key operations.....	23
Specifications.....	24
Probes.....	25
Accessories.....	26

Safety & Cautions

CE NOTICE

The VF500-PS10HD is in conformance with the following standards:

- 2014/30/EU Electromagnetic Compatibility Directive

FCC NOTICE

FEDERAL COMMUNICATIONS COMMISSION INTERFERENCE STATEMENT

This equipment has been tested and found to comply with the limits for a Class B digital device, pursuant to part 15 of the FCC Rules. These limits are designed to provide reasonable protection against harmful interference in a residential installation. This equipment generates uses and can radiate radio frequency energy and, if not installed and used in accordance with the instructions, may cause harmful interference to radio communications. However, there is no guarantee that interference will not occur in a particular installation. If this equipment does cause harmful interference to radio or television reception, which can be determined by turning the equipment off and on, the user is encouraged to try to correct the interference by one or more of the following measures:

- Reorient or relocate the receiving antenna.
- Increase the separation between the equipment and receiver.
- Connect the equipment into an outlet on a circuit different from that to which the receiver is connected.
- Consult the dealer or an experienced radio/ TV technician for help.

CAUTION

Any changes or modifications not expressly approved by the grantee of this device could void the user's authority to operate the equipment.

RoHS NOTICE

The VF500-PS10HD is in conformance with the requirements of the European law on the Restriction of Hazardous Substances (RoHS) directive. This means that our product is both lead-free and without the hazardous substances either in the manufacturing process or in the final product.

SAFETY GUIDE

USER MUST PAY ATTENTION TO THE INFORMATION PROVIDED HERE TO ENSURE SAFETY.

We suggest you read the following statements carefully before using the system. If the product is used in a manner not specified by the manufacturer, the protection provided by the product may be impaired.

CAUTION If this product is used without observing the information given under this symbol, it might cause damage to this product.

CAUTION BATTERY

- VF500 is supplied with an internal, rechargeable li-on battery.
- DO NOT replace the battery by yourself. MUST access your product vendor's after service if any battery malfunction.
- Disposal of used battery according to the local regulations.

CAUTION CERTAIN SUBSTANCES MAY DAMAGE THE PROBE

- Please refer to Chemical resistance below. Contact the store you purchased for unsure chemical solutions for further information.

Chemical Resistance:

- Water
- Brake fluid
- Gasoline
- Diesel fuel
- Transmission fluid

WARNING If this product is used without observing the information given under this symbol, it might cause injuries or loss of life.

WARNING HAZARD ENVIRONMENT

- Do not use the product in explosive environments such as gasoline or alcohol storage tank.

WARNING This product does not support hot swap. Please always connect the compatible probe properly before switch on. Switch off the product before changing the probe.

1. Product Outlook

1.1 PS10HD

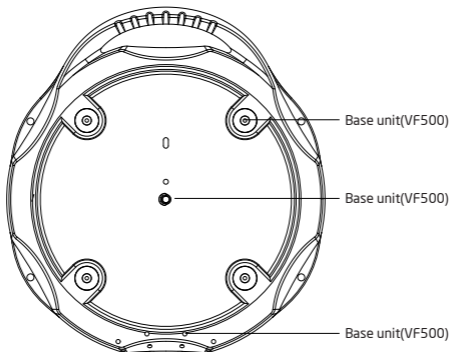
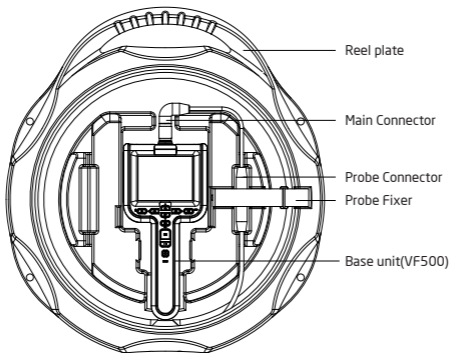

1.2 VF500

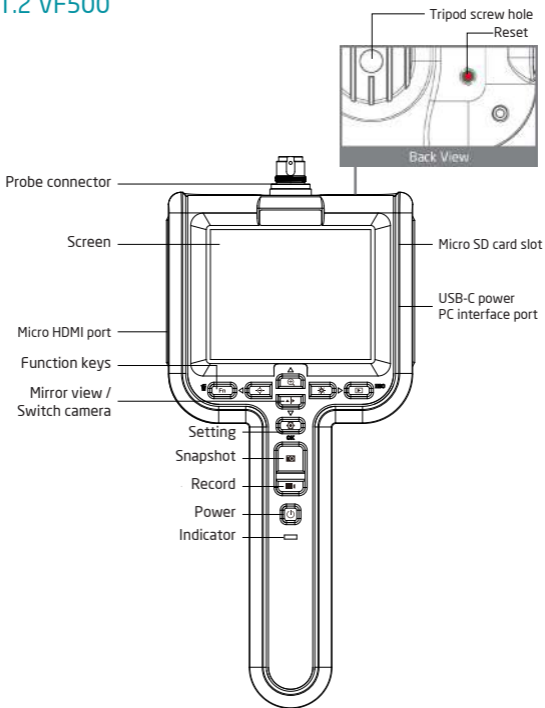

2. Getting started

Step1: Attachment of the base unit. Loose the manual screw from the back side to detach the VF500 base unit. DO NOT withdrawal the screw for proper assembly operation.

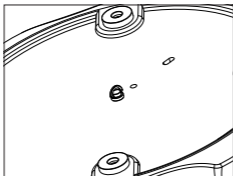

Step2: To attach back, align the screw hole of VF500's back to the screw and properly tightly screw it on.

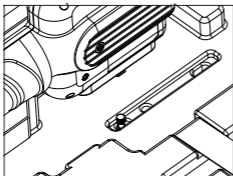

Step3: Ensure that a micro SD card is inserted properly.

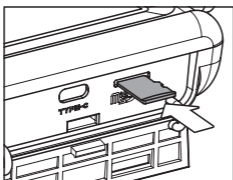
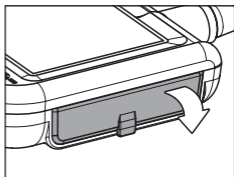
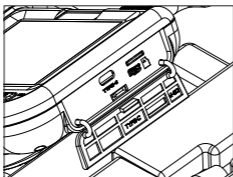

Step4: Long press the power button to switch on.

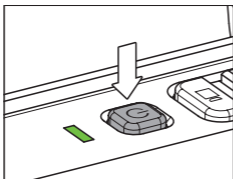

Step5: After switched on VF500, aim the camera head to inspection area. Press the snapshot or record button to take an image or video.

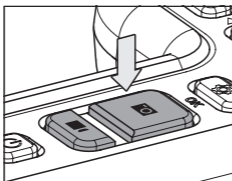

Screen



3. Main functions

This system provides 3 easy-to-operate modes: "Preview", "Browse" and "Menu".















Preview: Once the system turns ON, "Preview" mode is activated. Images received by the system are shown on the screen real-time. Under the "Preview" mode, users may take pictures or videos.

Browse: Under "Browse" mode, users may view pictures and videos and conduct basic file management.

Menu: Under "Menu" mode, users may change system settings.

Note: Under the "Menu" mode, the system will back to the "Preview" mode if no actions are made in 150 seconds.

3.1 Multifunction keys

Key	Preview	Browse	Menu
Fn / 	Enable special functions (Negative/Brightness/Contrast)	Delete file	N/A
 / 	Increase brightness(*)	Right	
 / 	Decrease brightness	Left	
 / 	Zoom in	Up	Up
 /  / 	[Short press]: switch front/side view [Long press]: mirror image effect	Down	Down
 / ESC	Enter the "Browse" mode	Return to "Preview" mode	Return to "Preview" mode
 / OK	Enter the "Menu" mode	Execute/confirm instruction	Execute/confirm instruction
	Snapshot	N/A	N/A
	Video recording While recording video, you can take picture by press 'Snapshot'	N/A	N/A
	Power on/off		



* The system provides 10 levels brightness control.

Zoom-in & Mirror

Zoom-in: Press  to zoom in the image 1.5x, 2x, and press again to the original image.



* Original image



* Enlarged 2X

Mirror: Long press  to get the mirror image effect(as shown below).



*Original image





*Activated

3.2 System mode

Menu

Step1: Press  to enter the Menu mode.

Step2: Press the button  or  to select the item you need.



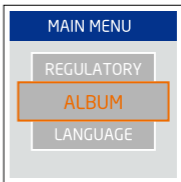

Step3: Press **OK** to enter.



In the menu:

Album

The user may manage images or videos in the memory card through this function.

Step1: Press  or  or  or  to choose any image or video you need. to retrieve the image.

Step2: Press **OK** to retrieve the image. While browsing video, press the **OK** to play or pause playback.

Step3: Press  to delete.

Step4: Press  again to confirm , or press **ESC** to skip.



Total images
Shooting time



Language

To select operation language.

Date/Time

The user may set system time through this instruction.

Format: Set sequence of year, month, day.

Setting: Set the system's time.

Display: Set if time is to be shown on Preview mode.

Step1: Press ► or ◀ button to select day, month or year to be changed.

Step2: Press the button ▲ or ▼ to adjust.

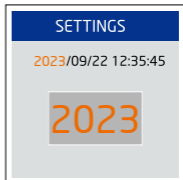

SD Card status

Delete all files

Delete pictures taken by the system.

Format SD card

Delete all files stored in the memory card.

SD card status

Show available capacity in the SD card.

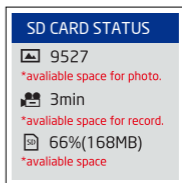

Settings

Auto power off

You can set auto power off after 5 mins or 10 mins, you can disable the auto power off function by selecting off.

Recording timer

The system provides auto recycle video recording until SD card storage is full. It provides 4 setting options of each clip length: 5/10/15/20 minutes, and default is 10 minutes.

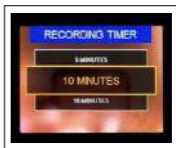

USB

- When the USB port is connected to PCs, choose output to be:
 - (1) SD card reader: To access the files saved in the SD card.
 - (2) Camera: To perform the video scope as a PC webcam. The system supports online meeting platforms include:
Google Meet, Zoom, Skype, and Microsoft Teams. Herby, we take skype for example. Users shall follow the specific webcam setting of each platform.
- The USB port support power supply when connected to a power bank or PC host USB port with 5V power-out.



Skype communications

Step1: Connect VF500 to your PC via USB-C port select webcam mode and press OK.



Step2: Log on your Skype and select "Videoscope" from settings, the screen will immediately share the live view from VF500.

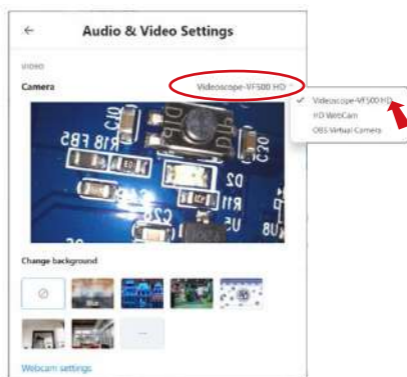

Step3: Live sharing



USB videoscope

The software enables Mitcorp videoscope to work on PC. Download the software to PC. After the software is correctly installed connect the VF500 with supplied USB cable. Power on the VF500, select CAMERA the open the software USB Videoscope.

Operating system: Win10 and higher version.

System requirement: CPU AMD Athlon II 2GHz above (Quad core)/
Independent graphics card/ card/ RAM 4G or above.

Contact Mitcorp for the software.





REGULATORY



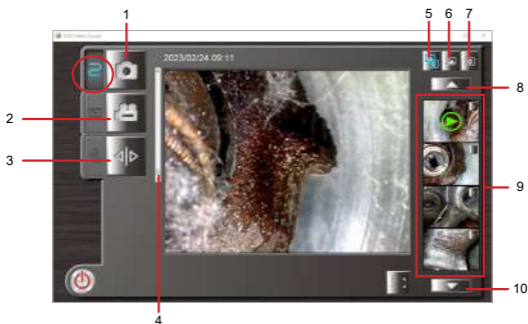



OPERATION

Instant mode



1. Snapshot - Click  button or `space bar` from the application window, or press the Snap button on the console to take a photo.
2. Video record - Click  button or `Ctrl + R` key on the application window to start recording video. To stop recording, click the Rec button on the application.
3. Mirror - Click  or `Ctrl + M` key to flip the image horizontally.
4. Zoom in - Roll up the bar to zoom in the image from x1.0 to x4.0, You can also click the  key on your PC to zoom in, click the  key on your PC to zoom out.

5.  Preview both photos/videos or **Alt** + **A** key.
6.  preview photos only, or **Alt** + **P** key.
7.  Preview videos only, or **Alt** + **V** key.
8. Click  to previous file, or **PgUp** key.
9. Display 4 latest photo/video, press **1** ~ **4** key to preview
10. Click  to next file, or **PgDn** key.

Browse Mode

Press 2nd TAB on the screen or press any picture/video on the preview window. The Browse mode will not function if no pictures/videos in the folder.



Mirror

Click  or **Ctrl** + **M** key to flip the image horizontally.

Rotate

Click  or **F2** key to rotate image counter-clockwise 90°.

Screenshot on video

You can click  or **space bar** key anytime during video playing to get still image.

Video Play

Click  to play selected video, or **Ctrl** + **P** key.

Click  to pause, click  to continue play, or **Ctrl** + **P** key.

Click  to stop the video, or **Ctrl** + **S** key.

Delete



Select the image click  on the up right of the photo / video image or **Delete** key.

* Back to instant mode, click **ESC** key.

Setting Mode

Destination folder set up



Select the destination folder to save images and videos, click  to change setting or  to skip and keep the default setting. (C:\Users\Documents\USB VideoScope)

Time stamp set up



Select the time stamp display format, all photos and videos will be saved with selected format on left bottom.

* Back to instant mode, click  key.

HDMI

For viewing images from an external monitor.

Connect the VF500 on the micro HDMI port with supplied HDMI cable to an external monitor. Switch on VF500 then switch on the external monitor.

3.3 **Fn** key operations

☀ Brightness control for screen display

◐ Contrast control for screen display

BW Black white mode



Activated



Negative mode

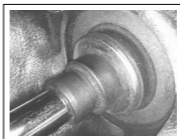

Specifications

Model	VF500
Display	3.5" LCD
Power supply	Rechargeable Li-battery
Video output	Micro HDMI
Data transfer/Charging	USB-C
Storage	Micro SD up to 64GB
Image format	JPEG, 1280x960
Video format	MP4, 1280x960
Drop resistance	1 meter
Operating temp	Charge: 0°C~40°C
Charging temp	0°C~50°C
Storage temp	If the system is kept for a long time (3months or more), It is strongly recommended that the system is preserved at dry and low-temperature (approx.20°C)
Charging time	Charging: 2.5 hours/Discharge: 4.5 hours
Compatible probes	49HD-FS-1M-SR/39HD2W-F-1M-SS

Probes

Model	PS10HD-F-10M-FRP
Diameter	28.0 mm
Length	10 m
Direct of view	Front view
Illumination	Front LEDs
FOV(Field of View)	150°
DOF(Depth of Field)	20 mm~∞
Articulation	N.A.
Buttons	N.A.
Material	FRP
Liquid resistance	Unleaded gasoline, diesel, machine oil, brake oil, transmission oil, water
IP Rating	IP67
Working temp	-10°C~60°C
Storage temp	If the system is kept for a long time (3months or more), It is strongly recommended that the system is preserved at dry and low-temperature (approx.20°C).
Relative humidity	Max 95% non-condensing
Compatible base units	VF500

P.S. Mitcorp company reserve the right of design change and explanation of the specification data.

Accessories

Accessories	
USB cable (data transfer & Charger)	1m, type C to type A (NEW)
User manual version	English
Package	Blow mode case + Carton

