



---

# **Premium Handheld Thermal Camera**

**User Manual**

---

## About this manual

This manual is used as a guide and the photos, graphics, icons and illustrations provided in the manual are for explanation and illustration purposes only and may differ from the specific product, please refer to the actual product. This manual may be updated by FOTRIC without notice due to product version upgrade or other needs. The trademarks and images used in this manual are for illustrative purposes only and are the copyright of the trademark owner.

## Disclaimers

The products (hardware, software, etc.) provided in this manual may be defective, faulty or malfunctioning, and fotric disclaims all warranties of any kind, express or implied, including, but not limited to, warranties of merchantability, satisfactory quality, fitness for a particular purpose, non-infringement of third party rights, etc. fotric will not be liable for any special, incidental, consequential or indirect damages arising out of the use of this manual or our products. including, but not limited to, damages arising from loss of business profits, loss of data or documentation.

To the maximum extent permitted by law, our liability will not exceed the amount you paid for the product.

After the product is connected to the Internet, it may be exposed to risks including but not limited to network attacks, hacker attacks, virus infections, etc. The Company will not be responsible for any abnormal operation of the product, information leakage, etc. as a result, but will provide you with technical support in a timely manner.

Products can sense motion detection and fire events when properly installed and configured, but cannot prevent accidents or resulting personal injury or property damage.

Thermal imaging products are classified as export controlled by the U.S. Department of Commerce, Export Control Classification Number (ECCN) 6A003.b.4.b. This product contains a focal plane array, Export Control Classification Number 61002.a.3.f. This product may not be used in controlled countries (e.g. North Korea, Iran, Syria, Cuba, Sudan, etc.) and should not be brought into or used in controlled countries. Any loss or liability arising from the above actions will be borne by you.

When using this product, you are requested to strictly follow the applicable laws. You agree that this product is for civilian use only and shall not be used in violation of third party rights, medical/safety equipment or other applications where the failure of the product could result in life-threatening or personal injury, and for purposes such as mass destruction fog, biochemical weapons, nuclear explosions or any unsafe use of nuclear energy or dangerous or inhumane uses. Any loss or liability arising from such use will be borne by you.

In the event of a conflict between the above and applicable law, the provisions of the law shall prevail.

# Preface



User Manual



Analysis Software



## Symbols

 Warning	 Caution	 Note
potential death or serious injury inducing hazards.	potential danger of injury or property damage.	provides additional information to emphasize the main text.

## Safety information

The purpose of this section is to ensure that the user uses the product properly to avoid danger or property damage.

Before using this product, please read this instruction manual carefully and keep it in a safe place for future reference.



### Warning:

- Never disassemble or modify the thermal camera battery. The battery is equipped with safety and protective devices which, if tampered with, may cause the battery to overheat and may also cause an explosion or burn. If the battery is leaking and the leak gets into your eyes, do not rub it, wash it with water and get immediate medical attention.
- Thermal cameras that use a laser pointer. Do not view the laser beam directly with the human eye. The laser beam can cause eye irritation.
- If the unit is not working properly, contact your dealer or our company and do not disassemble or modify the unit in any way (unauthorized modifications or repairs cause problems at your own risk).



### Caution:

- Avoid using the product in humid, dusty, extremely hot or cold environments, please refer to the product's parameter table for specific temperature and humidity requirements.
- Do not touch the sensor or lens directly to avoid staining and damage from oil and various chemicals. If cleaning is necessary, moisten a clean cloth and gently wipe off any dust. Close the lens cap when the thermal camera is not in use.

- When the thermal camera is turned on, it may take approximately 5-10 minutes for the camera to warm up before taking accurate readings.
- Avoid focusing or prolonged observation on the sun or objects with extremely high temperatures, as this may result in reduced sensor life damage or temporary black spots (minor cases can be recovered after calibrating the NUC, severe cases can result in permanent irreversible damage to the detector).
- Avoid damage to the sensor caused by over-range use of the device.
- It is strongly recommended to use the original power adapter, the specific requirements of the power adapter are shown in the product data sheet.
- To prevent the potential danger of data loss, always make a copy (backup) of your data on a computer.
- When storing the thermal camera, it is strongly recommended to use the original box and to keep it in a cool, dry, ventilated environment free from strong electromagnetic fields.
- When shipping the thermal camera, it is strongly recommended that it be shipped protected in its factory packaging.

---

# Table of Content

<b>1. PRODUCT COMPONENTS .....</b>	<b>1</b>
1. FRONT VIEW .....	1
2. REAR VIEW .....	1
3. TOP VIEW.....	2
4. BOTTOM VIEW .....	2
<b>2. PREPARATION .....</b>	<b>5</b>
1. INSERTING AND REMOVING THE BATTERY.....	5
1.1 Inserting the battery .....	5
1.2 Removing the battery.....	5
2. CHARGING .....	5
2.1 Charging through the charging dock.....	5
2.2 Charging directly with DC 12V.....	6
3. POWER ON AND OFF .....	7
3.1 Power On .....	7
3.2 Power Off .....	7
4. SLEEP AND WAKE.....	7
5. CHANGE LENSES .....	8
6. ADJUSTING THE LENS ANGLE .....	9
<b>7. FOCUSING .....</b>	<b>10</b>
<b>8. CONNECTING TO EXTERNAL DEVICES AND STORAGE MEDIA .....</b>	<b>10</b>
9. INSTALLING THE WRIST STRAP .....	10
10. INSTALLING THE NECK STRAP .....	11
11. MOUNTING ON A TRIPOD .....	11
12. INSTALLING ON TEST BENCH.....	12
<b>3. THERMAL IMAGE DISPLAY.....</b>	<b>12</b>
1. DROPDOWN MENU .....	12
2. IMAGE MODE.....	13
2.1 Infrared Image Mode.....	13
2.2 T-DEF® Blend Mode.....	14
2.3 Picture-in-Picture .....	14
2.4 Digital Camera .....	15
2.5 Auxiliary Digital Camera .....	15
2.6 Dual-vision Display .....	16
3. PALETTES.....	16
3.1 Inverted Palette.....	16
4. COLOR ALARM.....	17
5. TEMPERATURE SCALE/SPAN.....	19
6. DIGITAL ZOOM.....	21
7. IMAGE OVERLAY INFORMATION.....	22
7.1 Global/Regional Information Display .....	22

7.2 Other Additional Information Displayed .....	23
8. MAXIMUM AND MINIMUM TEMPERATURE TRACKING .....	24
8.1 Global Maximum and Minimum Temperature Tracking .....	24
8.2 Regional Maximum and Minimum Temperature Tracking .....	25
9. HIGH TEMPERATURE DIFFERENCE EQUALIZATION IMAGING (T-TWB®) .....	25
10. IMAGE DETAIL ENHANCEMENT (IREEDGE) .....	26
<b>4.THERMAL IMAGING MEASUREMENT AND ANALYSIS .....</b>	<b>27</b>
1. TEMPERATURE MEASUREMENT RANGE .....	27
2. GLOBAL TEMPERATURE MEASUREMENT PARAMETERS .....	27
3. MEASUREMENT TOOLS (ROI) .....	28
3.1 Add Spots .....	29
3.2 Add Areas .....	29
3.3 Add Lines .....	29
4. LINE TEMPERATURE DISTRIBUTION .....	30
5. REGIONAL EMISSIVITY CORRECTION (PARTIAL EMISSIVITY) .....	31
6. REGIONAL ALARM .....	31
7. TEMPERATURE RISE .....	33
8. ON-DEVICE ANALYSIS .....	34
9. ANALYSIS SOFTWARE .....	35
<b>5.THERMAL IMAGING BASIC PARAMETERS .....</b>	<b>35</b>
1. SUPER RESOLUTION (SR) .....	35
2. FOCUS MODE .....	36
2.1. Manual Focus .....	36
2.2. Auto Focus .....	36
2.3. Continuous Focus .....	37
2.4. Touch Screen Focus .....	38
3. IR DEVICE SETTINGS .....	39
<b>6. CAPTURE FUNCTIONS .....</b>	<b>39</b>
1. SINGLE FRAME CAPTURE .....	40
1.1 File Naming Format .....	40
2. TIME-LAPSE CAPTURE .....	41
3. VIDEO RECORDING .....	42
3.1 Radiometric Video Recording .....	43
3.2 MP4 Video Recording .....	44
3.3 Video Format .....	44
4. FREEZE INTERFACE .....	45
5. QR CODE SCAN .....	46
6. VOICE ANNOTATION .....	47
7. TEXT ANNOTATION .....	48
8. TAG TABLE .....	49
9. FAVORITES .....	51
10. SKETCH .....	52

---

11. GALLERY.....	52
12. ON-DEVICE REPORT.....	55
<b>7. PLUG-INS .....</b>	<b>56</b>
1. NAVIPDM VENUS .....	56
<b>8. CONNECTION .....</b>	<b>56</b>
1. WIFI CONNECTION.....	56
2. BLUETOOTH .....	57
3. USB INTERFACE .....	58
4. HDMI INTERFACE .....	58
5. FTP.....	58
6. PC RADIOMETRIC VIDEO STREAM.....	59
7. REMOTE DISPLAY .....	59
<b>9. REMOTE CONTROL.....</b>	<b>59</b>
1. PC CONTROL.....	59
2. MOBILE DEVICE CONTROL .....	60
3. WEBPAGE CONTROL .....	60
<b>10.AUXILIARY FUNCTIONS .....</b>	<b>60</b>
1. INTELLIGENT FOCUSING SYSTEM (TURBOFOCUS®).....	60
2. FLOATING BALL.....	63
3. LASER .....	63
4. REGION FEATURE MEASUREMENT .....	64
5. GPS.....	65
6. COMPASS .....	66
7. LED LAMP .....	66
8. LANGUAGE.....	67
9. SOFTWARE AND FIRMWARE UPGRADES .....	68
10. DEVICE SET .....	71
<b>APPENDIX A.EMISSION TABLE.....</b>	<b>77</b>

---

# 1. Product Components

## 1. Front View

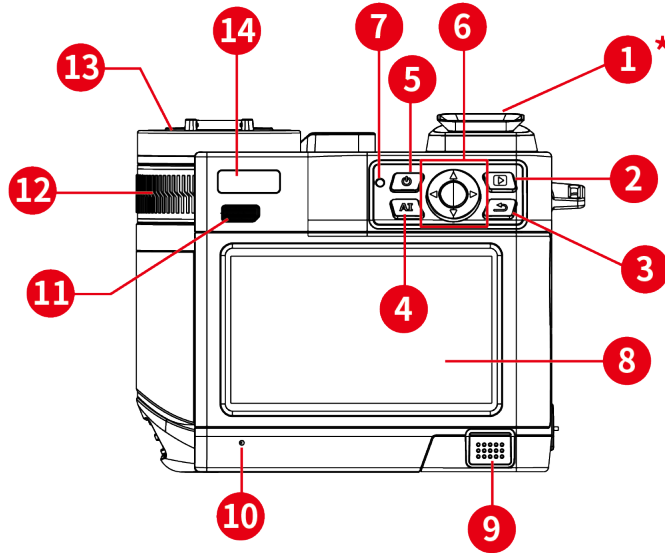

## 2. Rear View

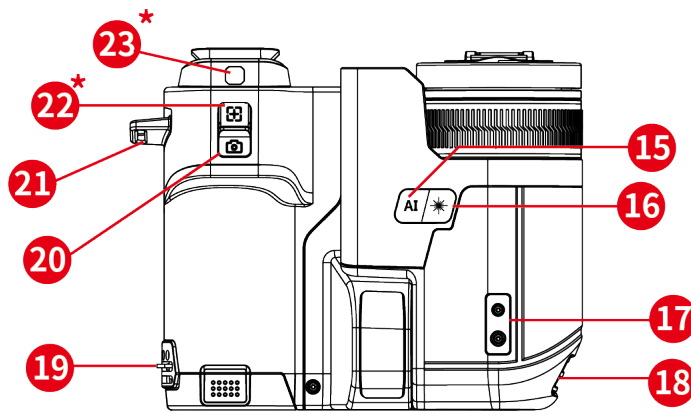

### 3. Top View

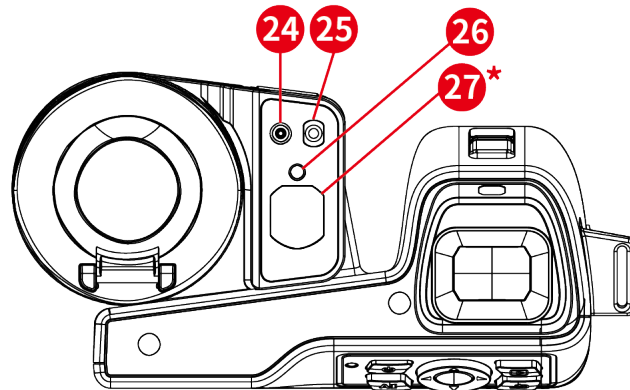

### 4. Bottom View

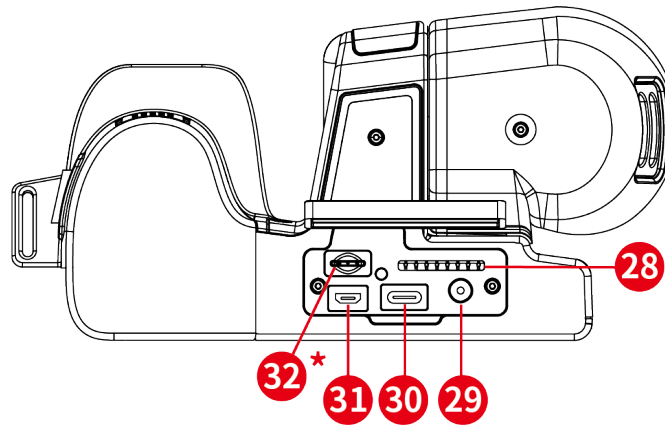

The appearance of different models of the product may vary. Please refer to the actual product.

#### Parts and interfaces

	Name	Function
1*	View Finder(optional)	Enable inspection through the view finder
2	Gallery Button	<ul style="list-style-type: none"><li>● Enter gallery</li><li>● Activate NUC(Non-Uniform Calibration) on the main interface</li></ul>

3	Back Button	Exit menu or back to the previous menu
4 & 15	AI Programmable Button	<ul style="list-style-type: none"> <li>● Short press: activate custom functions</li> <li>● Long press: select custom functions</li> </ul> Two buttons can link different functions
5	Power Button	<ul style="list-style-type: none"> <li>● Short press: power on/off device</li> <li>● Long press: sleep/wake screen</li> </ul>
6	Navigation Buttons	Menu mode <ul style="list-style-type: none"> <li>● Press▲, ▼, ◀, ▶to select parameters</li> <li>● Press confirmation key to confirm</li> </ul>
		Non-menu mode <ul style="list-style-type: none"> <li>● Press confirmation key to summon the menu</li> </ul>
7	Indicator LED	<ul style="list-style-type: none"> <li>● Green, blinking: charging</li> <li>● Green, glowing: fully charged, screen off</li> </ul>
8	Touch Screen	<ul style="list-style-type: none"> <li>● Display</li> <li>● Touch screen operation</li> </ul>
9	Battery	Lithium battery, for power supply
10	Microphone	Input voice information
11	Speaker	Play voice, alarm
12	Focus Ring	Rotate to adjust the clarity of images
13	Infrared Lens	For infrared imaging
14	Product Label	Display product logo
16	Laser Button	<ul style="list-style-type: none"> <li>● Press to activate laser</li> <li>● Release to deactivate laser</li> </ul>

17	Tripod Connection Interface	For mounting on a tripod
18 & 19	Neck Strap Bracket	For fixing the neck strap
19 & 21	Wrist Strap Bracket	For fixing the wrist strap
20	Freeze and Capture Button	Freeze and capture images/videos
22*	Autofocus Button(optional)	Press to conduct autofocus
23*	Digital Camera(optional)	Auxiliary digital camera
24	Digital camera	Digital visible-light camera
25	LED Flash Light	<ul style="list-style-type: none"> <li>● Flash light : serve as a flash light when taking photos</li> <li>● For illumination in dark environment</li> </ul>
26	Laser Emitter	For laser indications
27*	Laser Ranger(optional)	For laser ranging
28	SD Storage Card Interface	For inserting the SD card
29	Power Supply Interface	For connecting to DC power adaptor
30	USB Type-C Interface	<ul style="list-style-type: none"> <li>● For connecting to a USB Type-C cable</li> </ul>
31	Micro HDMI Interface	High resolution streaming interface, compatible to projecting to a HDMI screen
32*	Nano SIM Port (optional)	For inserting Nano SIM card

---

## 2. Preparation

### 1. Inserting and Removing the Battery

#### 1.1 Inserting the battery

Push the battery into the battery socket. When the battery is fully inserted, it will make a distinct 'click.'

#### 1.2 Removing the battery

Turn off the device, squeeze the snatch of the battery and take it out.

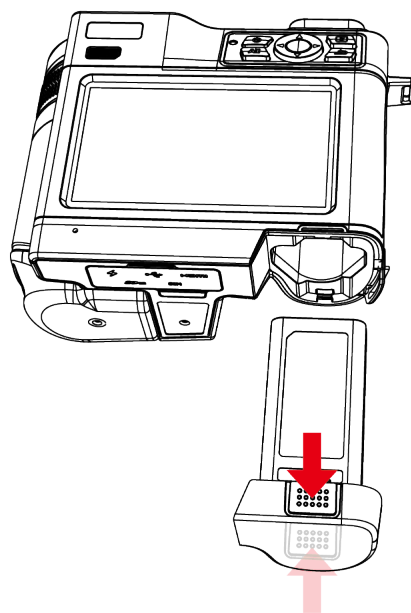

## 2. Charging

When using the thermal imager for the first time or when the power is low, please charge the thermal imager.

### 2.1 Charging through the charging dock

For quick charging take out the battery and mount it on the charging dock.

The voltage of the charging dock is 12VDC, please use the USB-C cable and the adaptor that came with the device.

#### Operation Procedures

1. Mount the battery(s) to the charging dock.
2. Connect the charging dock to the power source. If the dock is functioning normally, the middle LED indicators will glow green.
3. The LED indicators on the side indicate the charging status of the battery:
  - Red: charging
  - Green: charged

---

4. When fully charged, take out the battery and disconnect the dock from the power source.

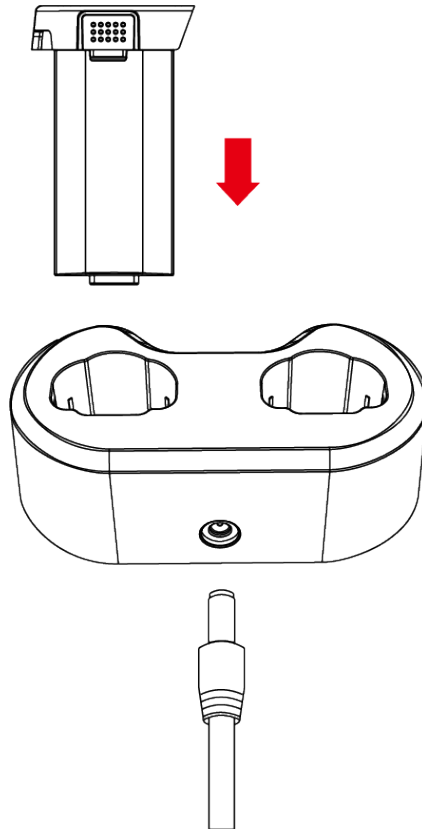

## 2.2 Charging directly with DC 12V

For expedient charging, directly charge the thermal imager through a DC 12V power adapter.

### Operation Procedures

1. Insert the battery
2. Lift the cover for USB-C interface
3. Connect to a power source and start charging

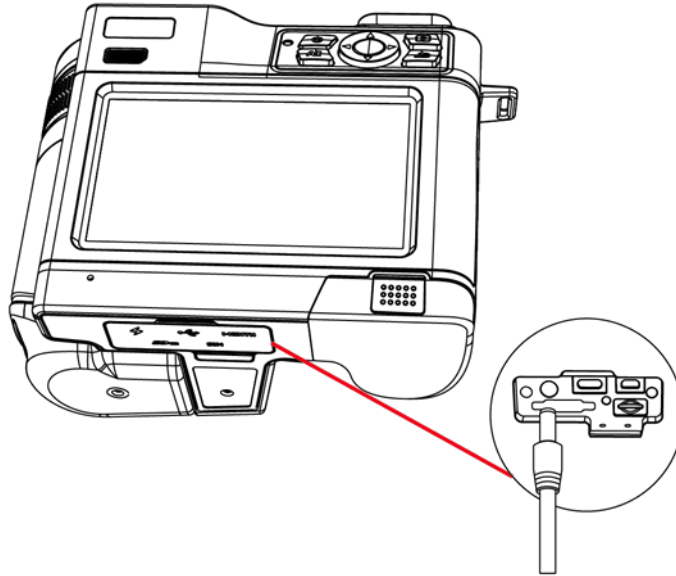

### 3. Power On and Off

#### 3.1 Power On

When sufficient battery power is available, press and hold the Power button to turn on. Once powered on, enters the real-time observation interface.



*Note:*

If battery power is low, charge or replace the battery promptly to avoid affecting usage.

#### 3.2 Power Off

Turn off manually or set an automatic shutdown time.

##### Manual Shutdown

Press and hold the Power button to turn off.

##### Automatic Shutdown

Set the automatic shutdown time. If no touch screen operation, no button press, and no USB connection, automatically shuts down after the set time is reached.

### 4. Sleep and Wake

Put into sleep mode manually to save power and extend battery life.

---

Press the Power button briefly to put into sleep mode or wake up.

## 5. Change Lenses

### Operation Procedures:

1. Press and hold the lens clamp to unlock the lens. Rotate the lens counterclockwise to unmount.
2. Carefully take off the lens
3. Align the red dot mark on the lens and the lens slot.
4. Gently push the lens in until it's firmly mounted.
5. Rotate clockwise until hearing a distinct 'click'.



### Caution

If you have purchased a new lens, please contact your dealer or the nearest service center to calibrate the new lens. This ensures optimal performance and compatibility between the lens and the device.

Before turning on the camera, make sure the lens is in place and locked securely. If it is not in place, the camera will not be able to recognize the lens when it is turned on.

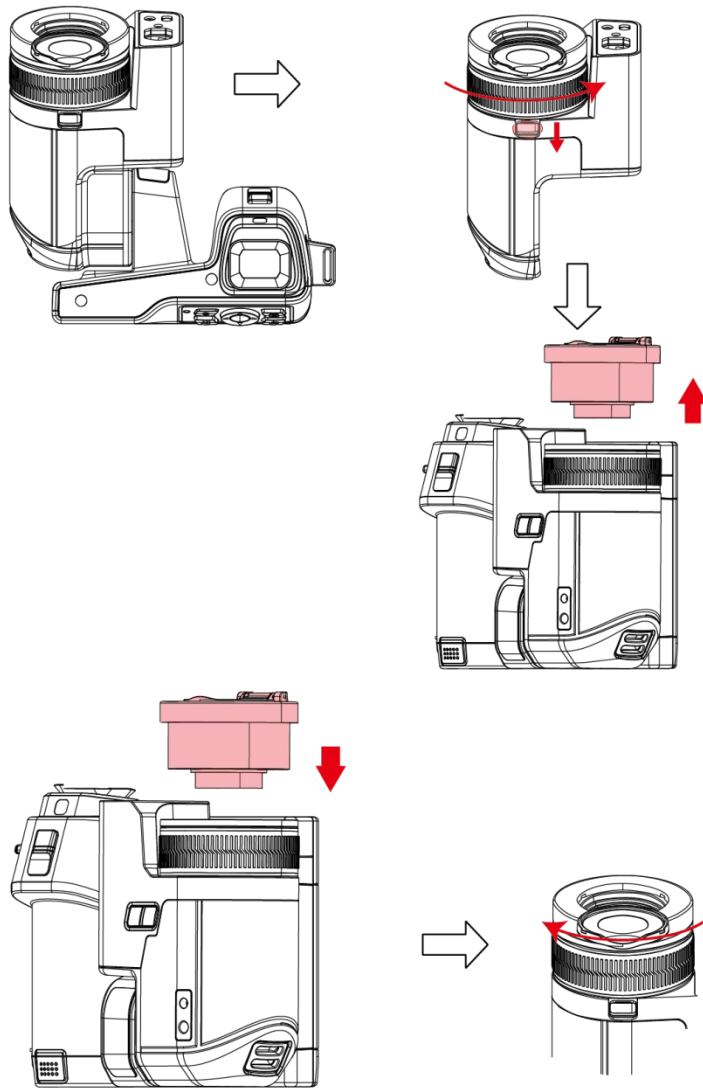

## 6. Adjusting the Lens Angle

Rotate the lens barrel to adjust the observing angle of the thermal camera.

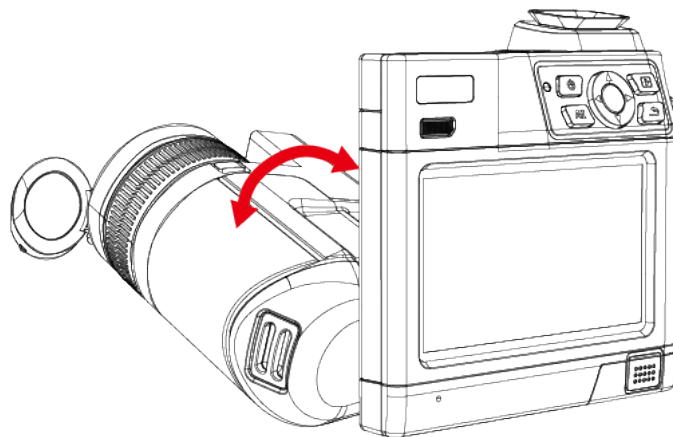

---

## 7. Focusing

Adjust the focus manually or automatically to make the captured scene image clear.

### Manual Focus

Point the lens at the scene to be observed, then rotate the focus wheel next to the lens clockwise or counterclockwise to adjust the focus.

### Auto Focus

Press the auto-focus button to automatically adjust the focus.



NOTE

This feature is supported on some models only; please refer to the actual device.

## 8. Connecting to External Devices and Storage Media

### External Devices

Use a compatible HDMI cable to connect one end to the device's Micro HDMI interface and the other end to a display. The image will be projected onto the connected screen.

### Storage Media

The device is equipped with a storage card to store captured inspection data, reports, and other files.



Note

The included storage card may vary; please refer to the actual device.

## 9. Installing the Wrist Strap

Inserting the strap through the Wrist Strap Bracket and tighten the strap (Refer to the item 21 of Parts and interfaces table) . Adjust the strap length based on your need.

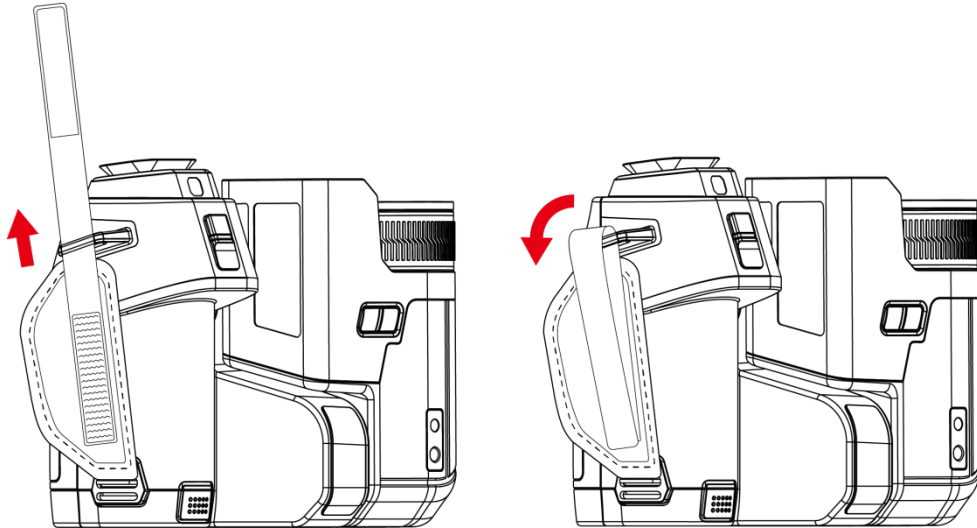

## 10. Installing the Neck Strap

Install the neck strap on the neck strap bracket (items 18 and 19 in the parts and interfaces table) of the device to prevent accidents. Pass one end of the neck strap through one of the neck strap holders and then secure the neck strap to the buckle, adjusting the neck strap length to your needs. Repeat the same steps to install the

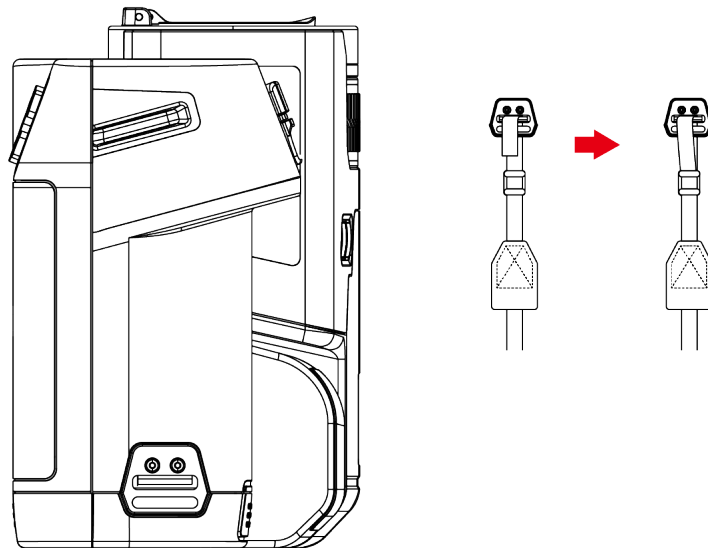

other end.

## 11. Mounting on a tripod

If the user need to make prolonged observation or measurements, we advise mounting the camera on a tripod.

The device support connecting to a tripod via a UNC 1/4-20 interface. (17<sup>th</sup> item in the **Parts and interfaces** table.

---

## 12. Installing on test bench

Some scientific research applications or models with macro lens require the use of a test bench.

The device is mounted on the test bench through a fixed bracket, and the use height can be adjusted by the knob.

Adjust the fixing ring to lock the device and tighten it to prevent the device from shaking or slipping.

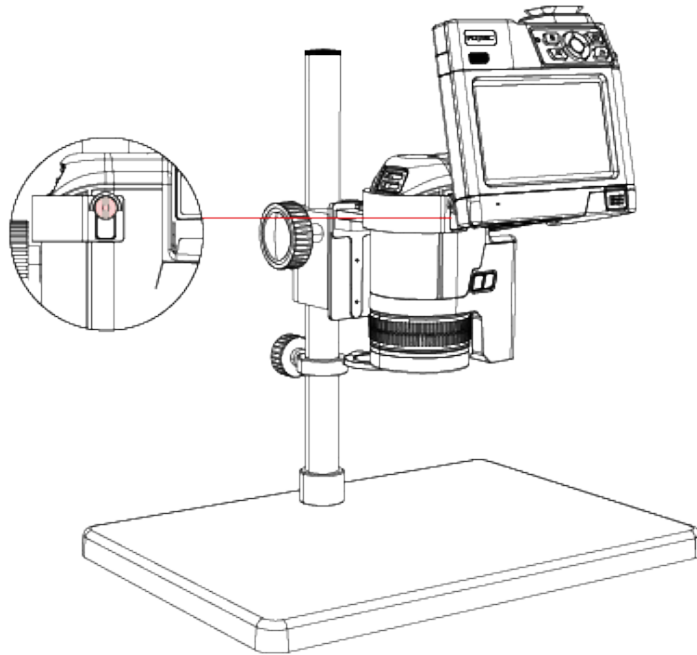

## 3. Thermal Image Display

### 1. Dropdown Menu

Users can swipe down from the top of the screen to bring up the system's drop-down menu. In this menu, users can toggle functions on or off or adjust settings through touch operations. When a function is turned on, its corresponding option will be highlighted. Users can quickly exit the drop-down menu by swiping up from the bottom of the screen.

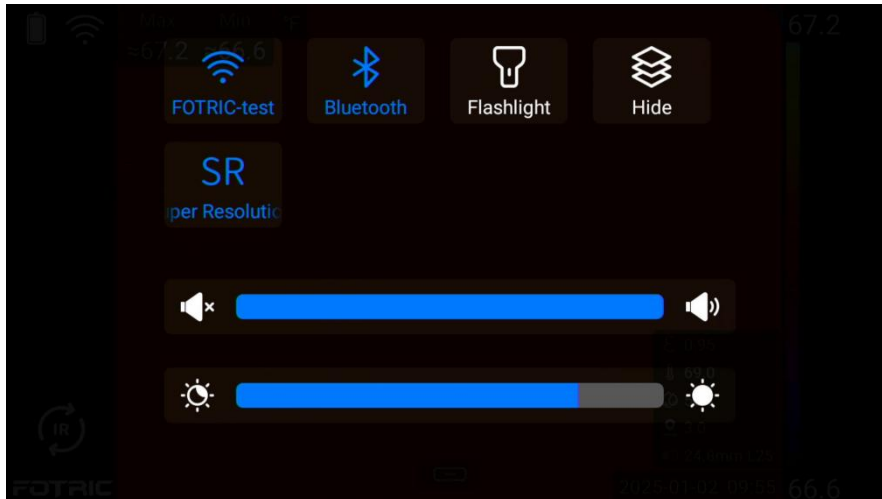

### Note

The interface displays different function switches depending on the specific model. Please refer to the actual device for details.

## 2. Image Mode

The device captures infrared and visible light images. Users can select different image modes to meet various image display needs. The specific steps are as follows:

1. **Live Interface:** When the device is in IR mode, press the OK button or tap the main menu to bring up the device menu.
2. **Device Menu → Image Mode**
3. Select the desired image mode

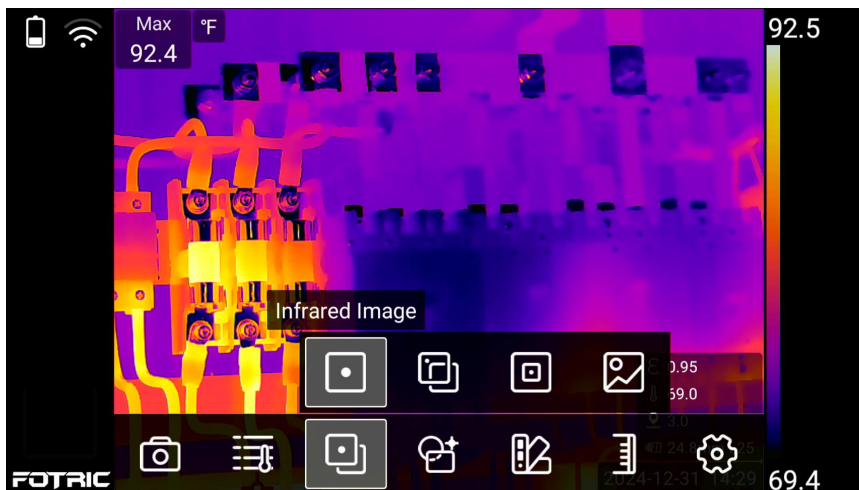

### 2.1 Infrared Image Mode

This mode displays infrared images.

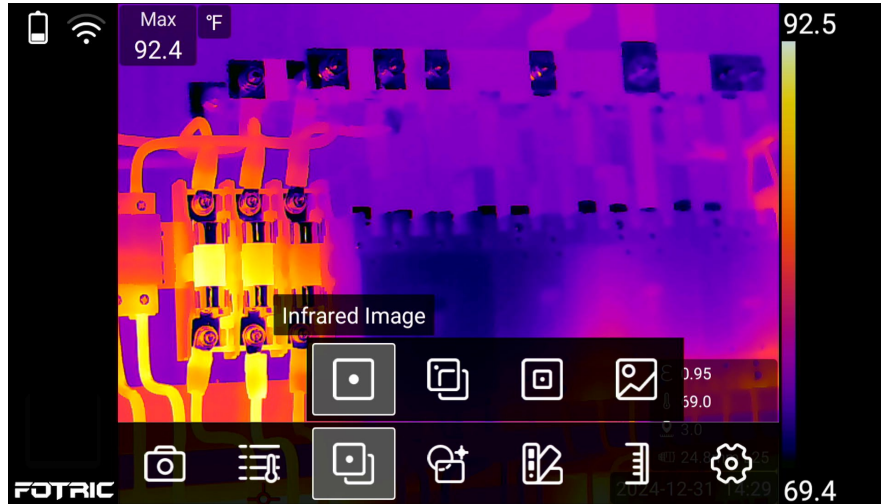

## 2.2 T-DEF® Blend Mode

This mode allows users to view both thermal and visible light real-time images simultaneously. Users can adjust the infrared image transparency from 0% to 100% by tapping the transparency

slider “” or using the left “” and right “” arrow keys. Additionally, users can press the OK button “” or the Back button “” to hide the adjustment slider.

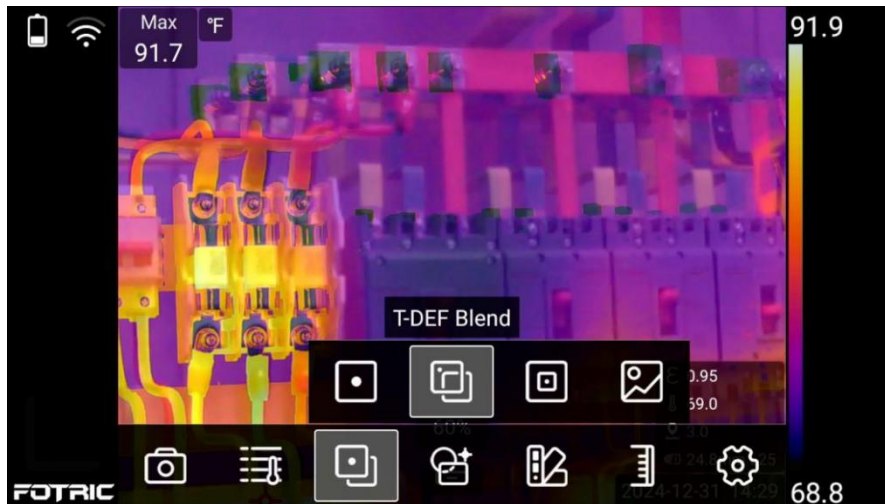



## 2.3 Picture-in-Picture

The mode overlays an adjustable infrared image on a visible light image, where the infrared image can be moved and resized. The user can select the center area of the infrared image by tapping the screen.

Once selected, the user can drag the center of the infrared image or use the arrow keys to move

---

the image position. Pressing the OK button “” switches to the size adjustment mode, where the user can drag the corners of the infrared image on the touchscreen or use the arrow keys to adjust its size. Pressing the back button “” exits the position or size editing mode for the infrared image.

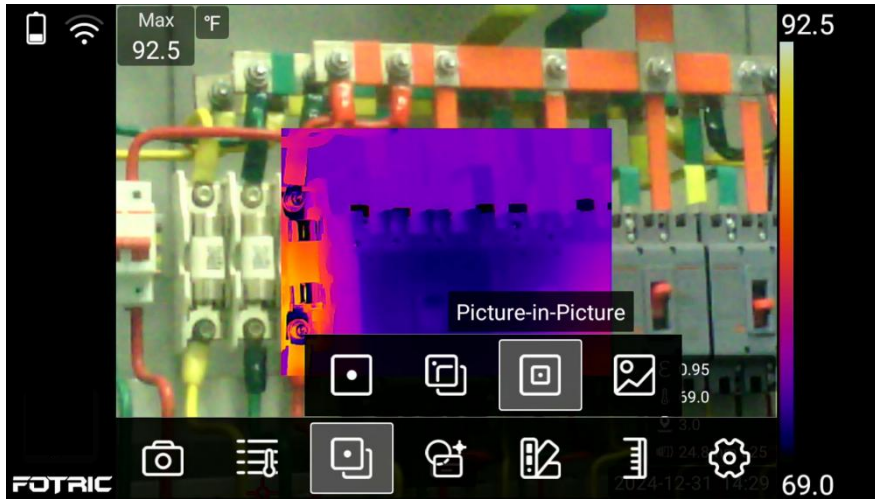

## 2.4 Digital Camera



This mode displays visible light images captured by the digital camera.

## 2.5 Auxiliary Digital Camera

This mode displays high resolution visible light images captured by the auxiliary digital camera.

---

## 2.6 Dual-vision Display

This mode overlays high resolution visible light images captured by the auxiliary digital camera onto the top right corner of the infrared image.

## 3. Palettes

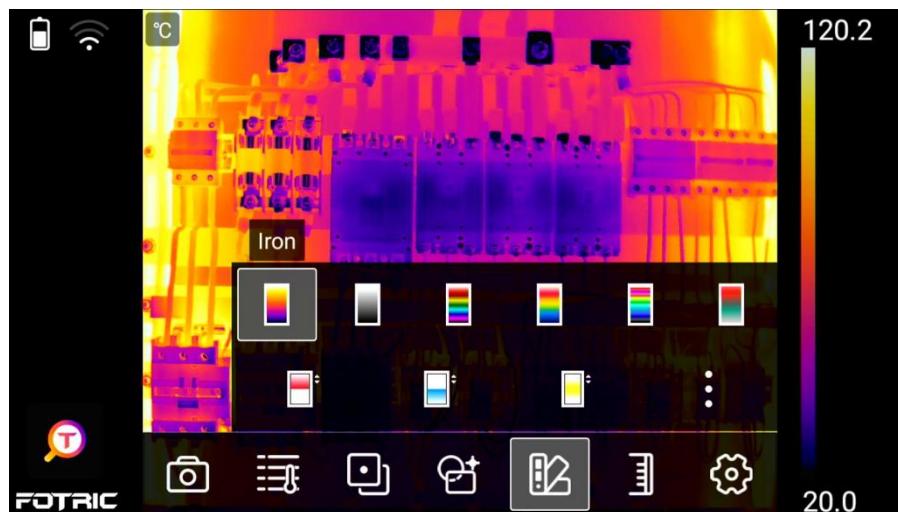

The device allows you to change the color palette to display different image colors, making images in various scenes clearer. The specific steps are as follows:

1. **Live Interface:** Press the OK button or tap the main menu to bring up the device menu->**Palettes**
2. Select the desired color palette, or go to **Device Menu → Palettes → More** , and then choose from more options.



### 3.1 Inverted Palette

The device allows you to invert the color palette to swap the colors corresponding to high and low temperatures, improving the image effect. The specific steps are as follows:

1. **Live Interface:** Press the OK button or tap the main menu to bring up the device menu
2. **Device Menu → Palettes → More** 
3. Tap **Invert Palettes** .

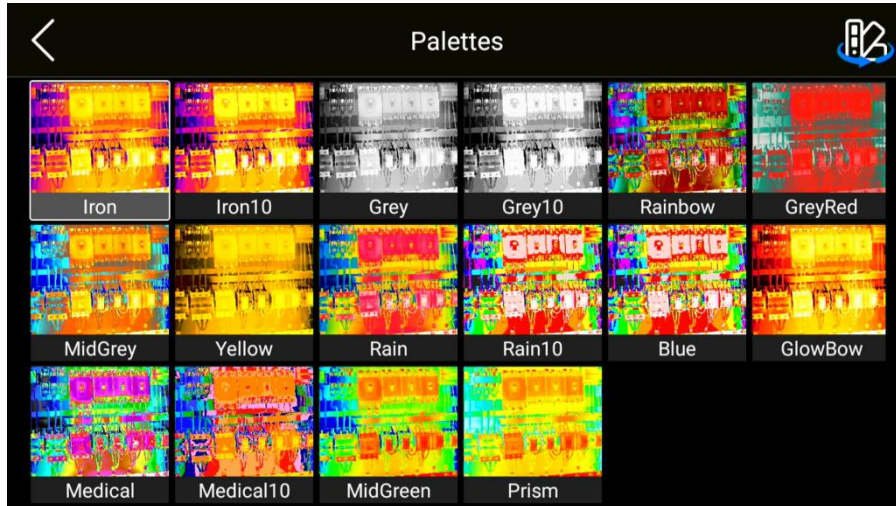

 **Note**

1. The different **palettes/inverted palettes** on the device vary depending on the specific model. Please refer to the actual device for details.
2. Before using the inverted color palette, enable: **Settings → IR Device Set → Measurement Enhancement → Palette Extension**



## 4. Color Alarm

The device supports alarms for Above Temperature Alarm, Below Temperature Alarm , Between Temperature Alarm, Humidity, and Insulation Color. This means the user can set alarm thresholds, and when the measured temperature or object meets the alarm conditions, the device will display an alarm color to help identify anomaly in the monitoring scenario. The specific operation steps are as follows:

In the main menu interface, press the OK button or touch the main menu to bring up the device menu.

- 
1. Device menu → Palette.
  2. Select the alarm color type, set the alarm thresholds, and then check for any abnormal situations.

**Above Temperature Alarm:** Display all pixels with a temperature higher than the alarm threshold in the alarm color.

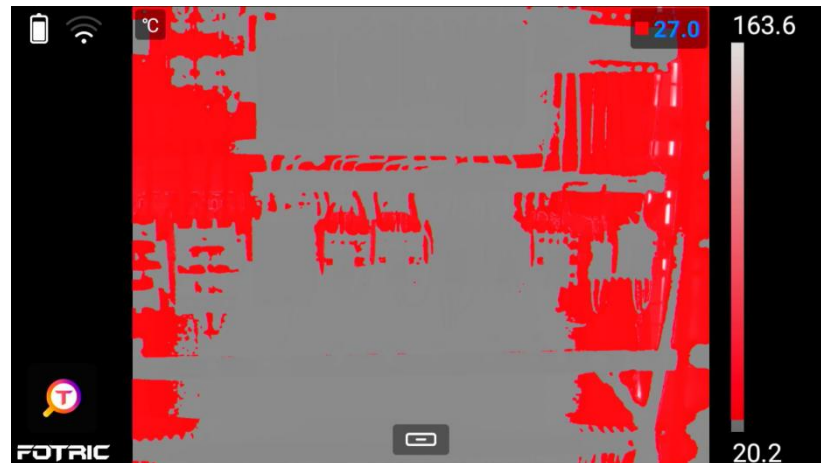

**Below Temperature Alarm:** Display all pixels with a temperature lower than the alarm threshold in the alarm color.

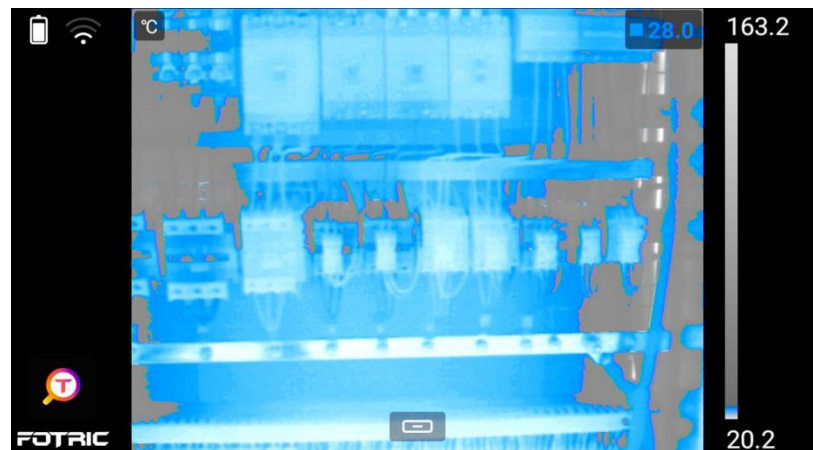

**Between Temperature Alarm:** Display all pixels with a temperature within the alarm threshold range in the alarm color.

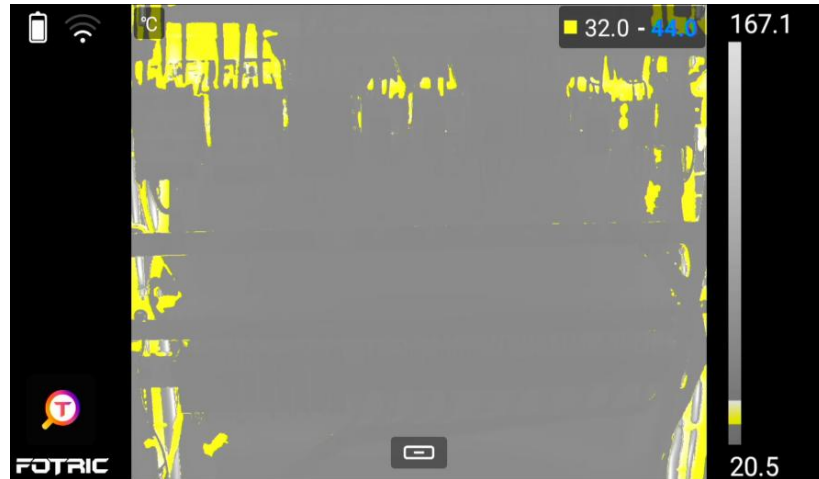

### Note

- 1.The color alarm on the device depends on the specific model. Please refer to the actual device for details.
- 2.Before using the color alarm, you need to enable it by going to: **Settings** → **IR Device Set** → **Measurement Enhancement**→ **Palette Extension**.

## 5. Temperature Scale/span

The device temperature span adjustment supports **automatic, manual, and touch modes**. The specific operation steps are as follows::

- 1.In the main menu interface, press the OK button or touch the main menu to bring up the device menu.
2. Device menu → Temperature Scale Mode.
3. Select the Temperature Scale Mode.

**Auto Span:** Adjust the upper and lower limits based on the global highest and lowest temperatures of the image.



**Manual Span:** Adjust the upper and lower limits to be close to the temperature of the specific target in the image.

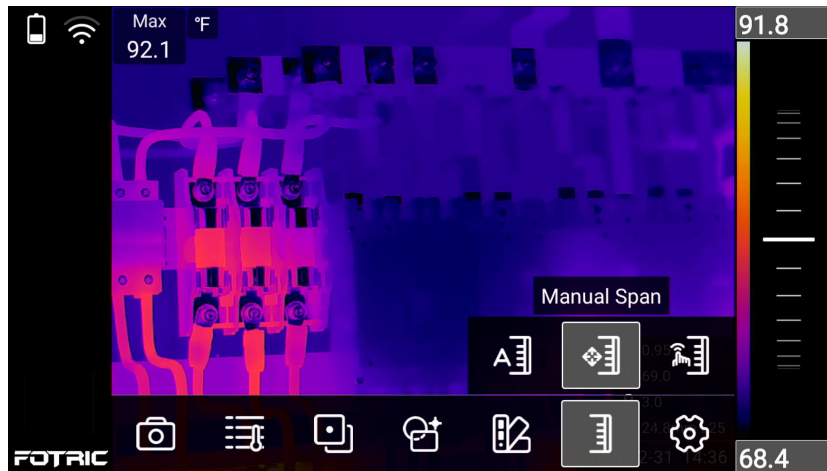

**Touch Span:** Adjust the upper and lower limits by tapping on the thermal image area.

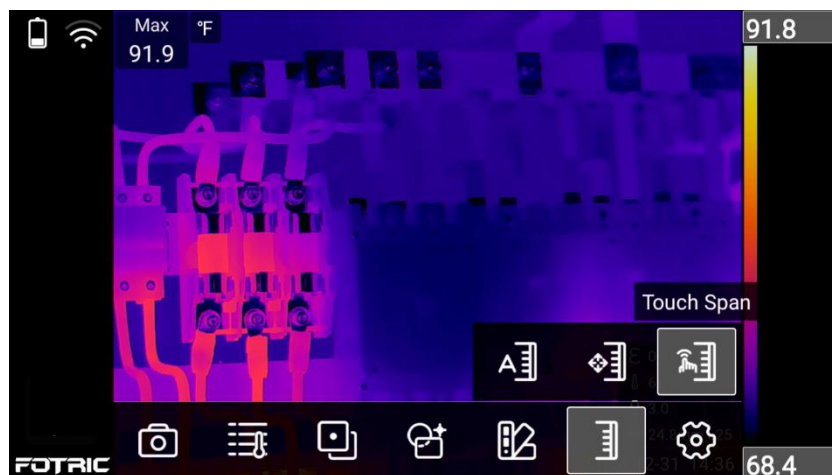

Select Manual Temperature Range mode to set different adjustment modes: **Device menu → Settings → IR Device Set → Manual Temperature Range Adjustment Mode.**

**Max/Min:** The upper and lower limits can be adjusted individually or simultaneously to modify the image display effect. In manual temperature range mode, the values can be adjusted by scrolling the wheel or pressing the up/down buttons. Alternatively, by clicking on the upper and lower limits or using the left/right keys, the user can switch between single or simultaneous adjustments of the values.

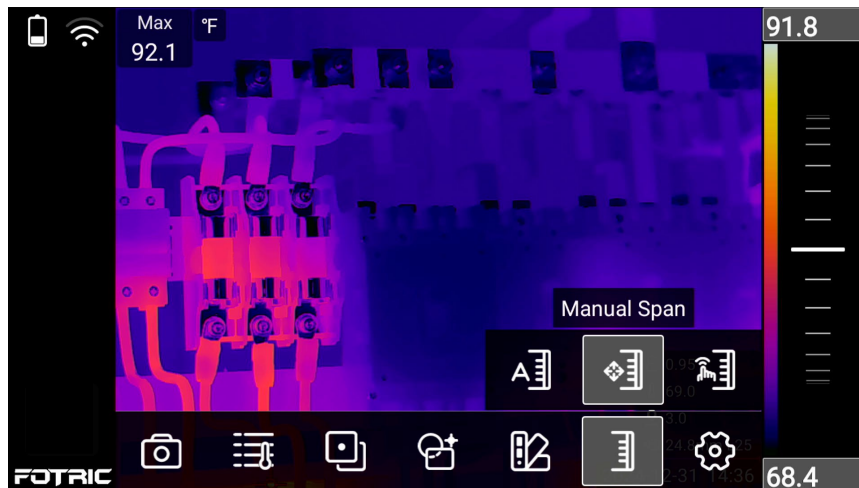

**Temperature Span:** The difference between the upper and lower limits can be adjusted to modify the image display effect. The upper and lower limits can be adjusted simultaneously by scrolling the wheel or pressing the up/down buttons. Alternatively, the temperature range width can be adjusted by pressing the left/right keys, with simultaneous adjustment of the upper and lower limits to match the change in temperature range width.

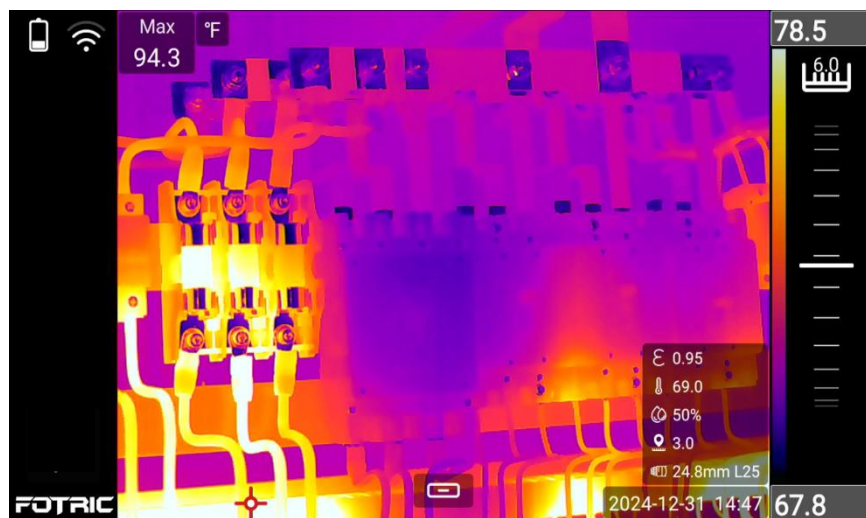

The Temperature Span Mode on the device depends on the specific model. Please refer to the actual device.

## 6. Digital Zoom

The digital zoom function of the device allows for controlling the scaling and display of images. The specific operation steps are as follows:

1. **Zoom In:** Tap the screen with two fingers and spread them outward.

2. **Zoom Out:** Tap the screen with two fingers and pinch them together.
3. When the zoom level exceeds 1x, a **zoom slider wheel** will appear. The user can adjust the zoom level by sliding the wheel on the touch screen or using the left and right direction keys. Press the OK button or the Back button to hide the slider wheel. Alternatively, the user can tap the zoom value again to bring up the zoom slider wheel.

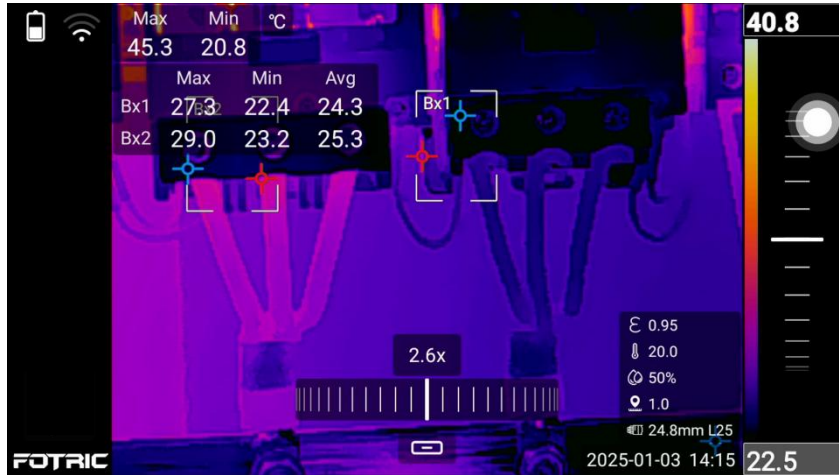

### Note

The digital zoom functionality of the device depends on the specific model. Please refer to the actual device for details.

## 7. Image Overlay Information

### 7.1 Global/Regional Information Display

This setting is used to specify the overlay display of global maximum temperature, minimum temperature, regional maximum temperature, minimum temperature, average temperature, and emissivity on the image. The specific operation steps are as follows:

1. In the main menu interface, press the OK button or tap the main menu to bring up the device menu.
2. Device menu → ROI → Display Settings

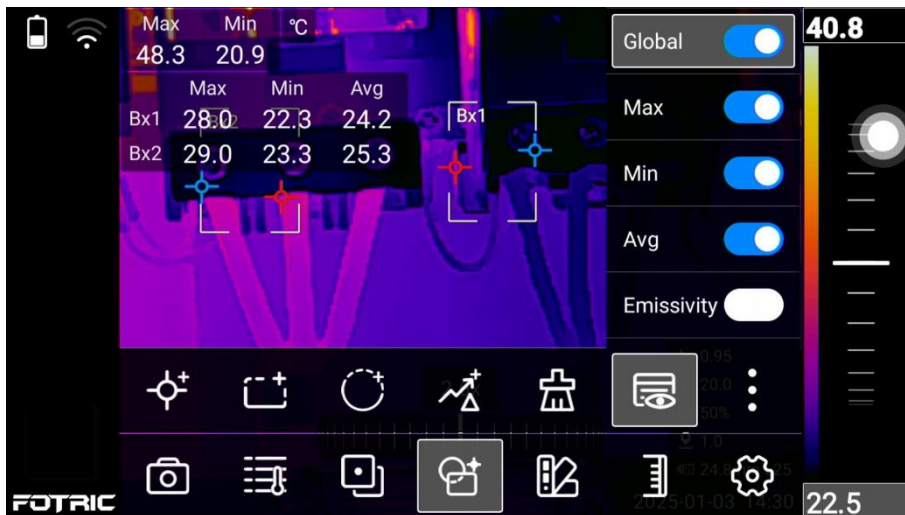

3. Enable the overlay for the maximum temperature, minimum temperature, average temperature, and emissivity. The global information will be displayed based on whether the global option and the maximum/minimum temperature options are enabled.

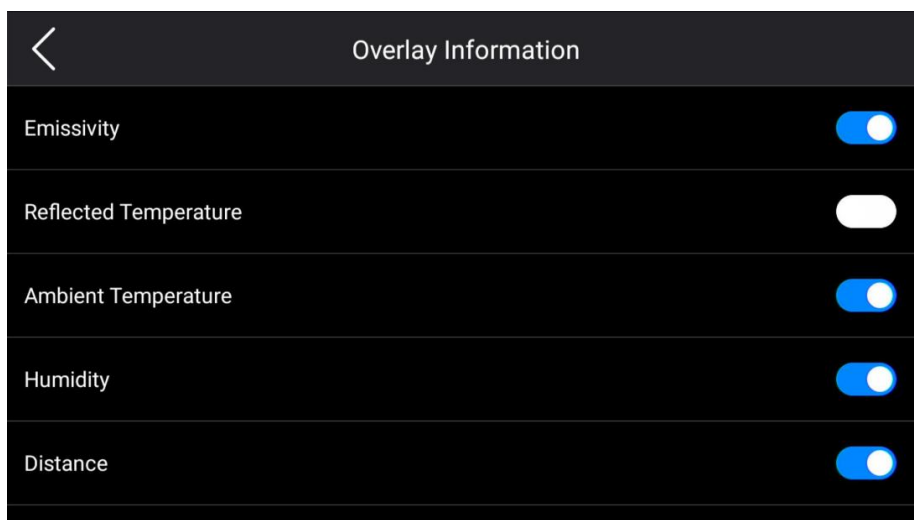

## 7.2 Other Additional Information Displayed

This setting is used to specify the temperature measurement parameters, lens, compass information, as well as the date and time information displayed as an overlay on the image. The specific operation steps are as follows:

1. In the main menu interface, press the OK button/tap the main menu to bring up the device menu.
2. **Device menu → Settings → IR Images → Overlay Information**

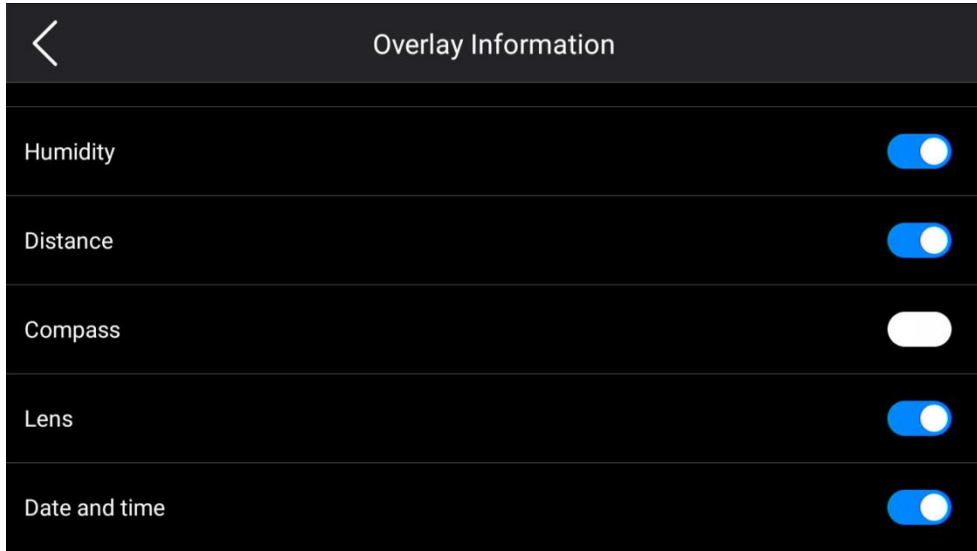

3. Enable the content to be overlaid

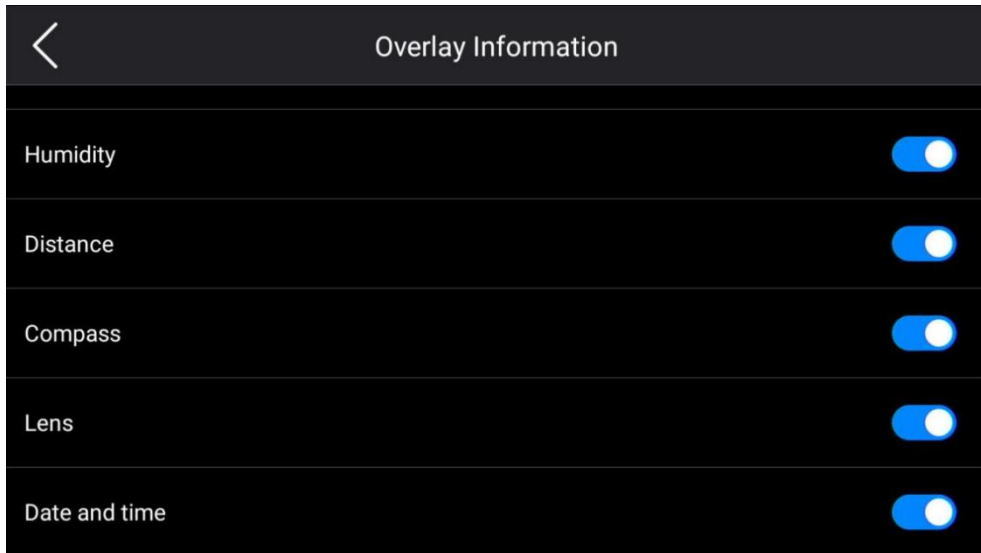

The overlay information options on the device vary depending on the specific model. Please refer to the actual device.

## 8. Maximum and Minimum Temperature Tracking

The device can automatically track the position of the maximum and minimum temperature points globally or within a specific area using special markers.

### 8.1 Global Maximum and Minimum Temperature Tracking

When the global highest and lowest temperatures are overlaid on the image, the position of the global highest temperature point is marked in red, and the position of the global lowest temperature point is marked in blue.



## 8.2 Regional Maximum and Minimum Temperature Tracking

When the highest and lowest temperatures of the region are overlaid on the image, the position of the region's highest temperature point is marked in red, and the position of the area's lowest temperature point is marked in blue.

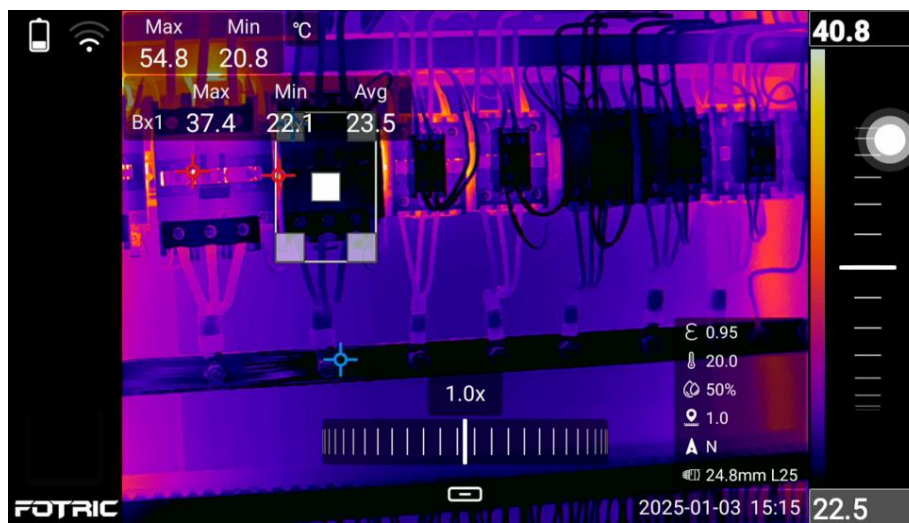

## 9. High Temperature Difference Equalization Imaging

### (T-TWB®)

This function optimizes the display of images with a wide dynamic range, effectively shielding interference from high-temperature heat sources and clearly showing the thermal gradient changes of the measured object. The specific operation steps are as follows:

- ✧ In the main menu interface, press the OK button/tap the main menu to bring up the device menu.

- ✧ **Device menu** → **Settings** → **IR Device Set** → **Measurement Enhancement** → **Image Enhancement**.

- ✧ Select the image mode with infrared imaging, press the OK button or click the mode again to bring up the menu.
- ✧ Enable T-TWB® function.

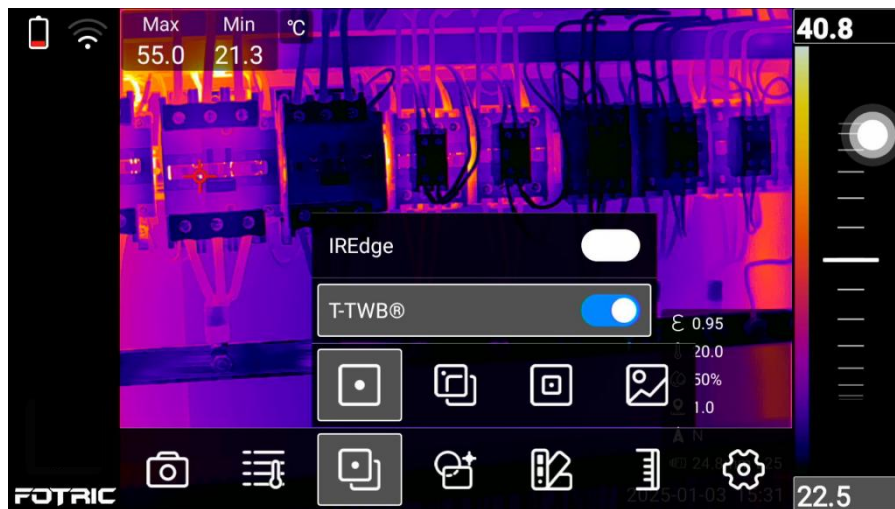

Whether the device supports this function depends on the specific model. Please refer to the actual device.

## 10. Image Detail Enhancement (IREdge)

This function supports IREdge infrared image contour enhancement, which allows for the recognition and sharpening of the measured object's infrared contours. It can significantly enhance the imaging details of target objects in complex scenes. The specific operation steps are as follows:

In the main menu interface, press the OK button or tap the main menu to bring up the device menu

- ✧ **Device menu → Settings → IR Device Set→ Measurement Enhancement→Image Enhancement**
- ✧ **Device menu → Image Mode**
- ✧ Select the image mode with **infrared image**, press the OK button or click the mode again to bring up the menu.
- ✧ Enable the image detail enhancement function.

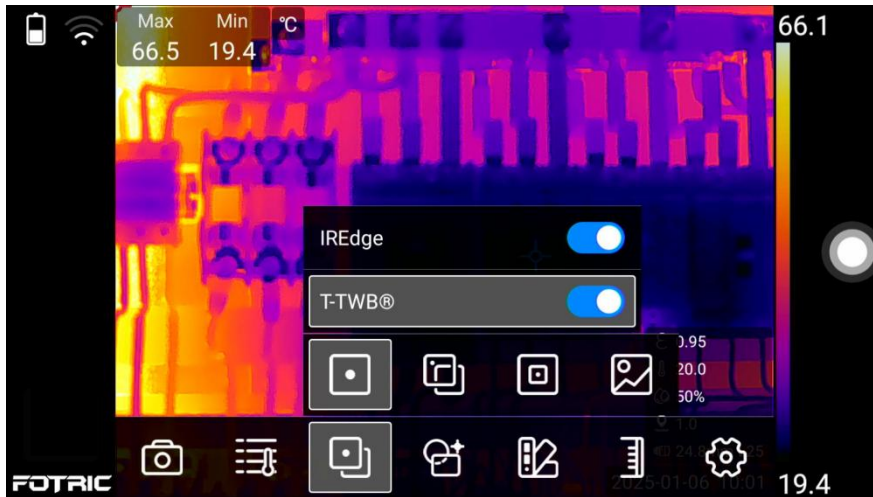

## 4. Thermal Imaging Measurement and Analysis

### 1. Temperature Measurement Range

The device supports different temperature ranges. To obtain accurate temperature measurements, the user needs to change the device's temperature measurement range to match the expected temperature of the measured object. The specific operation steps are as follows:

- ✧ In the main menu interface, press the OK button or tap the main menu to bring up the device menu.
- ✧ **Device menu → Settings → Temperature Measurement Range**
- ✧ Select the appropriate temperature measurement range.



#### Note

The temperature measurement range of the device varies depending on the product model. Please refer to the actual device for the specific model.

### 2. Global Temperature Measurement Parameters

To ensure accurate temperature measurements for different measured targets, please make sure to set the correct temperature measurement parameters. The specific operation steps are as follows:

- ✧ In the main menu interface, press the OK button or tap the main menu to bring up the device menu.
- ✧ **Device menu → Parameters → Emissivity**, change the corresponding parameter based on the measured object. The user can refer to Appendix A: Emissivity Table
- ✧ **Device menu → Parameters → Reflected Temperature**. When there is a high-temperature target in the scene, if the measured object has a low emissivity and reflects the high-temperature target, the reflected temperature should be set to the temperature value

of the high-temperature target.

- ✧ **Device menu** → **Parameters** → **Ambient Temperature**, change the corresponding parameter based on the current observation environment.
- ✧ **Device menu** → **Parameters** → **Relative Humidity**, adjust the corresponding parameter based on the current observation environment.
- ✧ **Device menu** → **Parameters** → **Target Distance**, adjust the corresponding parameter based on the distance between the measured object and the device.
- ✧ **Device Menu** → **Parameters** → **IR Window Compensation**, change the corresponding parameters, and set the on/off status, as well as temperature and transmittance.

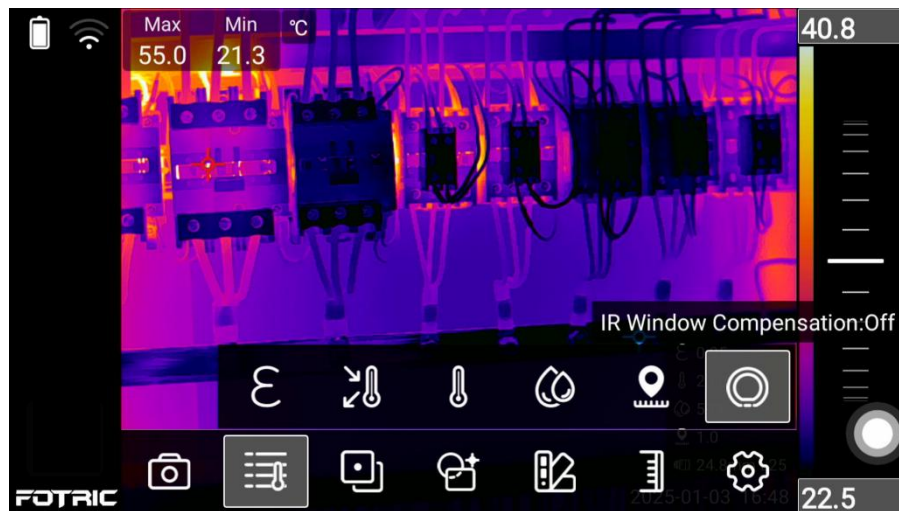

### 3. Measurement Tools (ROI)

The device can perform temperature measurement on points, lines, or areas by setting specific locations, boundaries, or regions of interest.

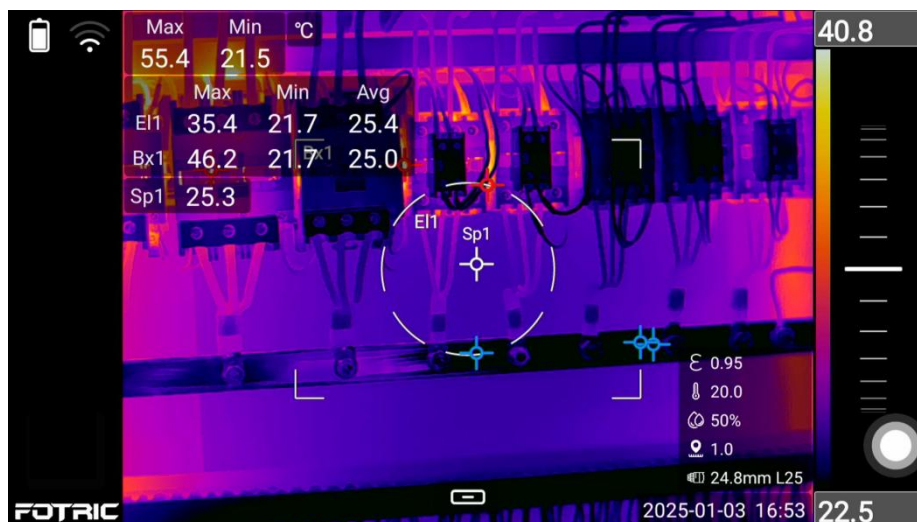

The specific operation steps are as follows:

- ✧ On the main menu interface, press the OK button or touch the main menu to bring up the device menu.

- 
- ✧ In the device menu, go to **ROI** → select temperature measurement tool
  - ✧ Touch and select the temperature measurement tool, then drag or use the arrow keys to move and adjust the position of the measurement tool.

### 3.1 Add Spots

The specific operation steps are as follows:

- ✧ On the main menu interface, press the OK button or touch the main menu to bring up the device menu.
- ✧ In the device menu, go to **ROI** → select **Add Spot**
- ✧ Touch the center area of the measurement tool, then drag or use the arrow keys to move and adjust the position of the measurement tool.
- ✧ Touch any of the four corner points of the measurement tool, then drag or use the arrow keys to adjust the size of the measurement tool.

### 3.2 Add Areas

The specific operation steps are as follows:

- ✧ On the main menu interface, press the OK button or touch the main menu to bring up the device menu.
- ✧ In the device menu, go to **ROI** → select **Add Rectangle/Circle**
- ✧ Touch the center area of the measurement tool, then drag or use the arrow keys to move and adjust the position of the measurement tool.
- ✧ Touch any of the four corner points of the measurement tool, then drag or use the arrow keys to adjust the size of the measurement tool.

### 3.3 Add Lines

The specific operation steps are as follows:

- ✧ On the main menu interface, press the OK button or touch the main menu to bring up the device menu.
- ✧ In the device menu, go to **ROI** → **More** → **Add Line**.
- ✧ Touch the center area of the measurement line, then drag or use the arrow keys to move and adjust the position of the measurement line.
- ✧ Touch either of the two end points of the measurement line, then drag or use the arrow keys to adjust the size of the measurement line.

---

 **Note**

The temperature measurement spot, line, and frame functions on the device may vary depending on the specific model. Please refer to the actual device for details

If the device supports temperature measurement lines, you need to enable the feature before using the measurement line:

**Settings → IR Device Set → Measurement Enhancement → Measurement Tool Extension**

## 4. Line Temperature Distribution

The device supports drawing the temperature distribution curve for the temperature measurement line. The specific operation steps are as follows:

- ✧ On the main menu interface, press the OK button or touch the main menu to bring up the device menu.
- ✧ In the device menu, go to **Settings → IR Device Set → Line Temperature Distribution**.
- ✧ Enable/disable the line temperature distribution function.

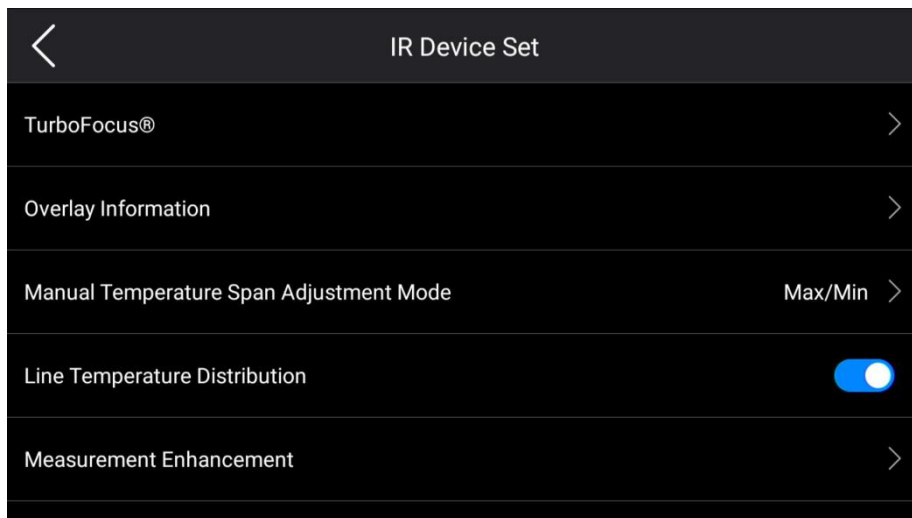
 **Note**

The line temperature distribution function of the device may vary depending on the specific model. Please refer to the actual device for details.

---

## 5. Regional Emissivity Correction (Partial Emissivity)

The device supports setting emissivity individually for each temperature measurement tool, allowing for precise temperature measurement in different areas. The specific operation steps are as follows:

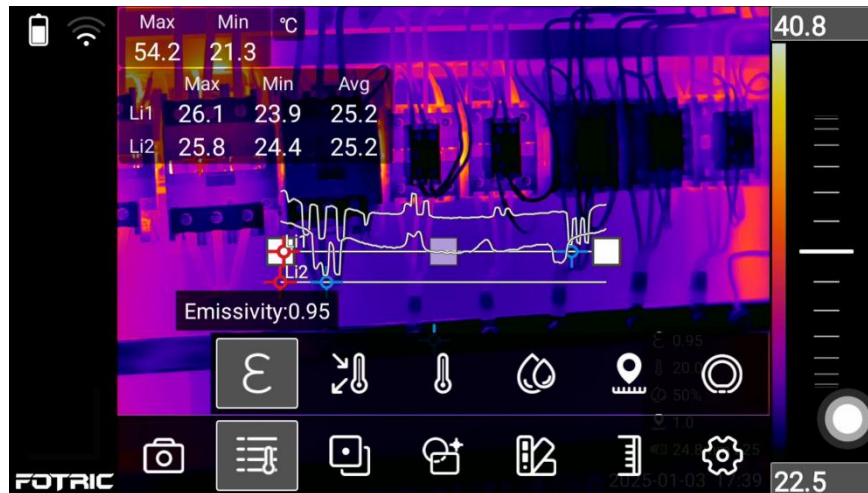

- ✧ On the main menu interface, press the OK button or touch the main menu to bring up the device menu.
- ✧ In the device menu, go to **ROI** → **Select a spot/area/line**.
- ✧ After selecting the ROI, press the OK button or touch the menu to bring up the temperature measurement object menu.
- ✧ In the temperature measurement object menu, go to **Emissivity**, enable/disable the function, and adjust the corresponding parameters based on the measured target. The user can refer to **Appendix A: Emissivity Table** for guidance

## 6. Regional Alarm

The equipment supports temperature alarms for the measured target in the observed scene. The specific steps are as follows:

- ✧ On the main menu interface, press the OK button or touch the main menu to open the device menu.
- ✧ **Device menu** → **ROI** → **Display Settings**, enable the Maximum Temperature and Minimum Temperature options.
- ✧ **Device menu** → **ROI** → **Select**.



- ✧ After selecting the **ROI**, press the OK button or touch the menu to open ROI menu.
- ✧ **ROI menu** → **ROI Alarm Settings**, where the user can set the on/off status, alarm threshold, and silent/buzzer modes.
  - ✧ **High Temperature Alarm:** The alarm is triggered when the highest/lowest temperature in the area exceeds the alarm threshold.

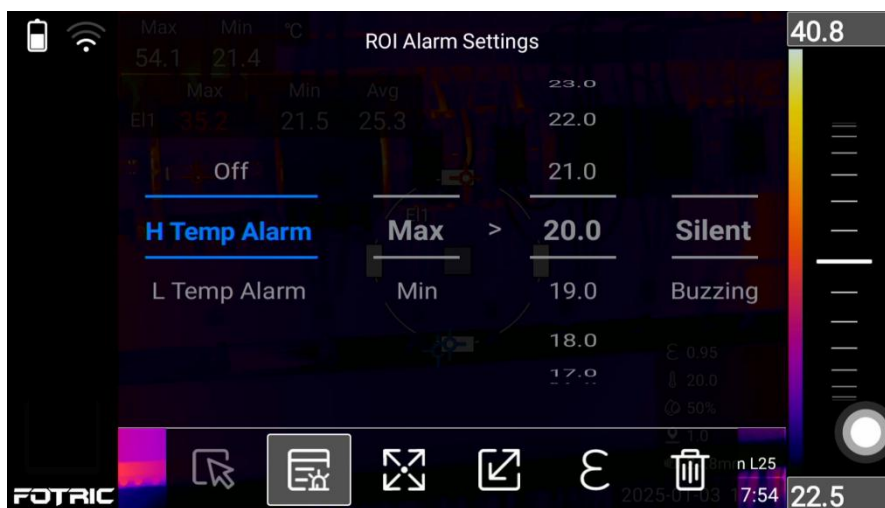

- ✧ **Low Temperature Alarm:** The alarm is triggered when the highest/lowest temperature in the area is below the alarm threshold.

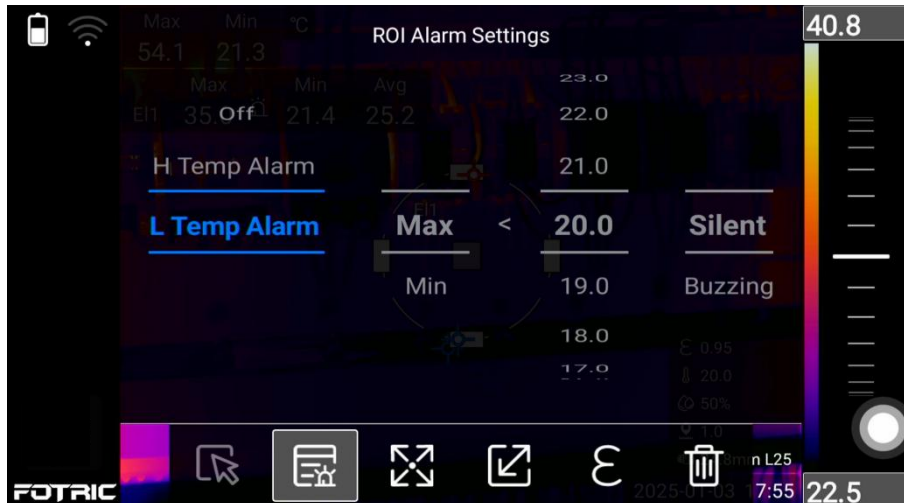

## 7. Temperature Rise

The device allows you to set a reference temperature, and all temperature values globally or within a specific region will be displayed as the difference from this reference temperature. The specific steps are as follows:

1. **Main menu interface:** Press the **OK** button or tap the main menu to open the device menu.
2. Go to **Settings** → **IR Device Set** → **Measurement Enhancement** → **Measurement Tools Extension Options**, and enable this function.
3. Navigate to **Device Menu** → **ROI** → **Add Temperature Rise**.
4. Configure the temperature rise's **On/Off status**, the **target**, and the **reference temperature Rise**.

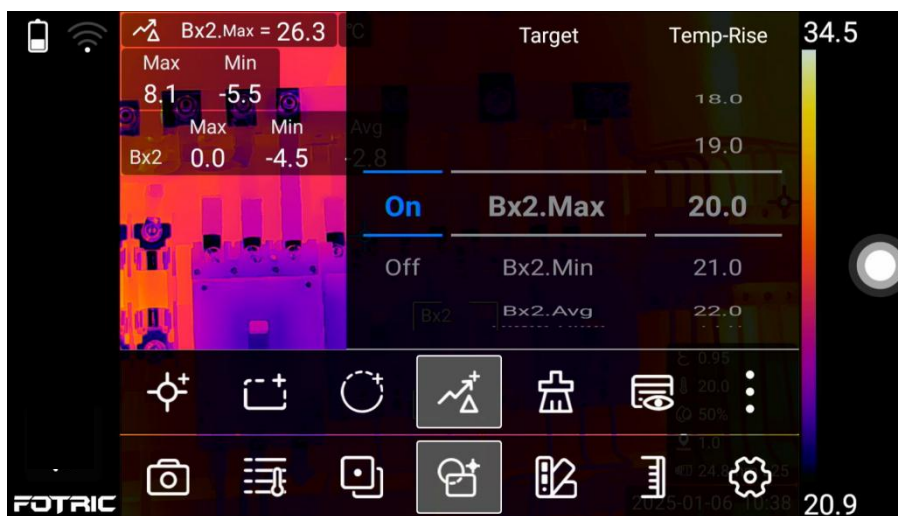

## 8. On-device Analysis

The device supports quick analysis of thermal images and radiometric videos to help promptly identify, analyze, and resolve issues. The specific steps are as follows:

1. Press the **Gallery** button to enter the gallery homepage.
2. Use the **touchscreen** or **directional keys** to select the thermal image or radiometric video to be analyzed.
3. Press the **OK** button to enter the gallery preview interface.
4. Press the **OK** button again to bring up the gallery preview menu.
5. Tap the **Analyze** button to access the gallery analysis interface.



6. Analyze the thermal image data and save the results. Press the **Back** button to exit.



---

## 9. Analysis Software

The device supports expert analysis software, enabling real-time control and display of infrared thermal images, infrared data analysis, and rapid batch generation of professional reports. For detailed instructions, please refer to the user manual of the analysis software.

## 5. Thermal Imaging Basic Parameters

### 1. Super Resolution (SR)

Super Resolution is an image enhancement feature that improves image resolution and reduces noise, making smaller targets easier to distinguish and measure. A SuperResolution image has twice the width and height of a standard image. The operation steps are as follows:

1. In the **main interface**, press the **OK** button or tap the main menu to access the device menu.
2. Navigate to **Device Menu** → **Settings** → **Storage & Save Options** → **Save as Super Resolution**
3. Toggle the feature **On/Off**.
4. Alternatively, in the real-time view, swipe down from the top of the screen to bring up the system dropdown menu, and then toggle the 'Super Resolution'(SR) **On/Off**

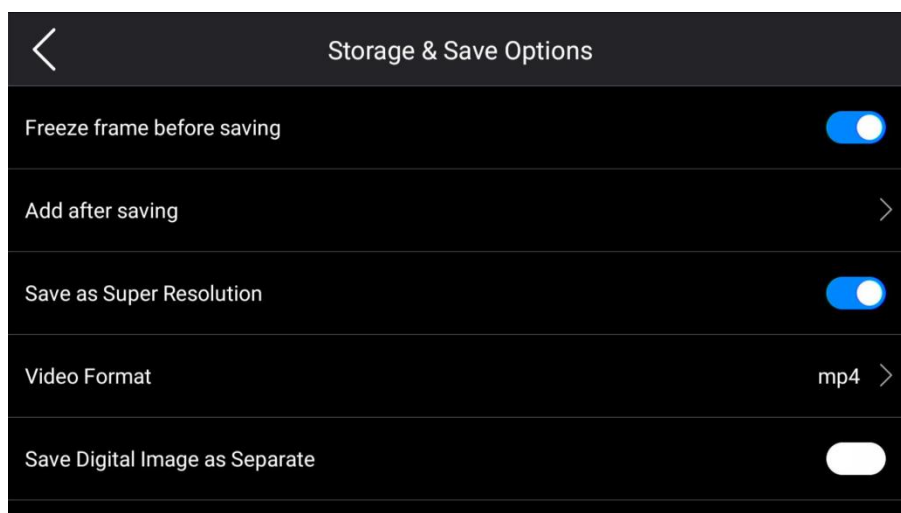

#### Note:

1. The availability of the Super Resolution feature depends on the specific device model. Please refer to the actual device for details.

- 
2. The Super Resolution feature only supports single-frame capture of infrared images. Otherwise, the images will retain their original resolution.

## 2. Focus Mode

Focusing allows the device to capture clearer and more accurate images, ensuring optimal image quality for analysis.



### 2.1. Manual Focus

Manual focusing is achieved by manually rotating the focus ring. To focus the device, aim the lens at the object to be observed and rotate the focus wheel located next to the lens in a clockwise or counterclockwise direction to adjust the clarity of the image.

### 2.2. Auto Focus

Users can press the **Auto Focus** button to automatically focus the device. The specific steps are as follows:

1. In the **main menu interface**, press the **OK** button or tap the main menu to access the device menu.
2. Navigate to **Device Menu → Settings → IR Device Set → Turbo Focus® → Auto Focus**.
3. Choose either **Contrast Thermal** or **Laser** for focusing:
  - 3.1 **Contrast Thermal**: Adjusts the focus based on maximizing image contrast.

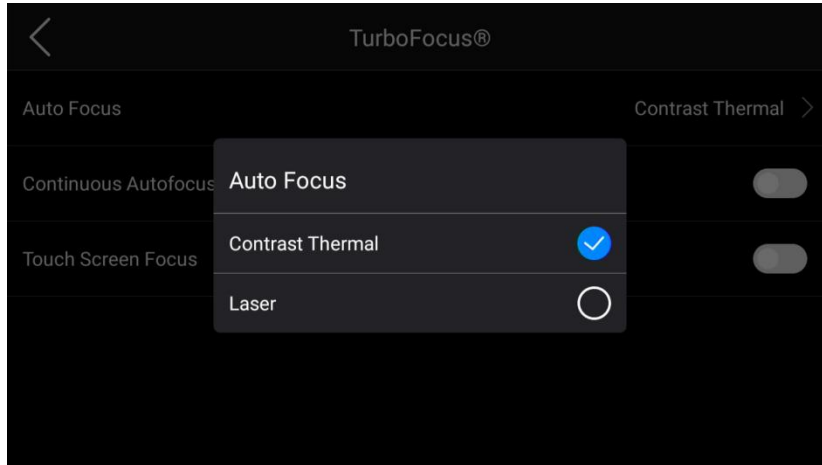

3.2 **Laser**: Adjusts the focus based on laser distance measurement.

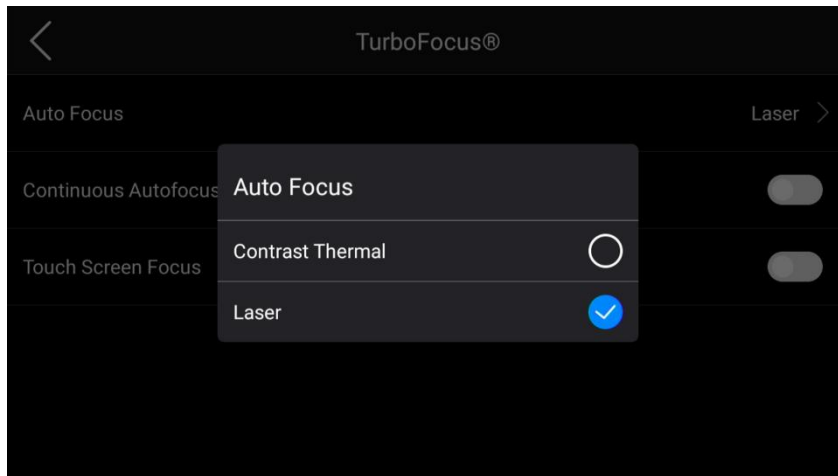

Aim at the target, and press the **Auto Focus** button to initiate the focus adjustment.

### 2.3. Continuous Focus

The device can be set to perform continuous auto focusing. The specific steps are as follows:

1. In the **main menu interface**, press the **OK** button or tap the main menu to access the device menu.
2. Navigate to **Device Menu** → **Settings** → **IR Device Set** → **Turbo Focus®** → **Continuous AutoFocus**.
3. The user can **enable** or **disable** this feature.

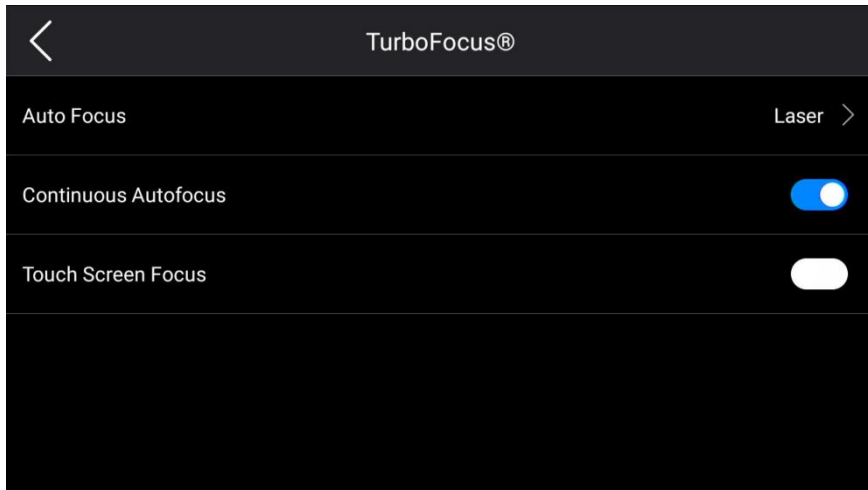

## 2.4. Touch Screen Focus

The device can also be set for touch focusing. The specific steps are as follows:

1. In the **main menu interface**, press the **OK** button or tap the main menu to access the device menu.
2. Navigate to **Device Menu → Settings → IR Device Set → Turbo Focus® → Touch Screen Focus**
3. The user can **enable** or **disable** this feature.
4. After enabling Touch Screen Focus, the user can tap on the visible area of the infrared image (where no menu or image overlay information is active) to automatically focus on the target area.

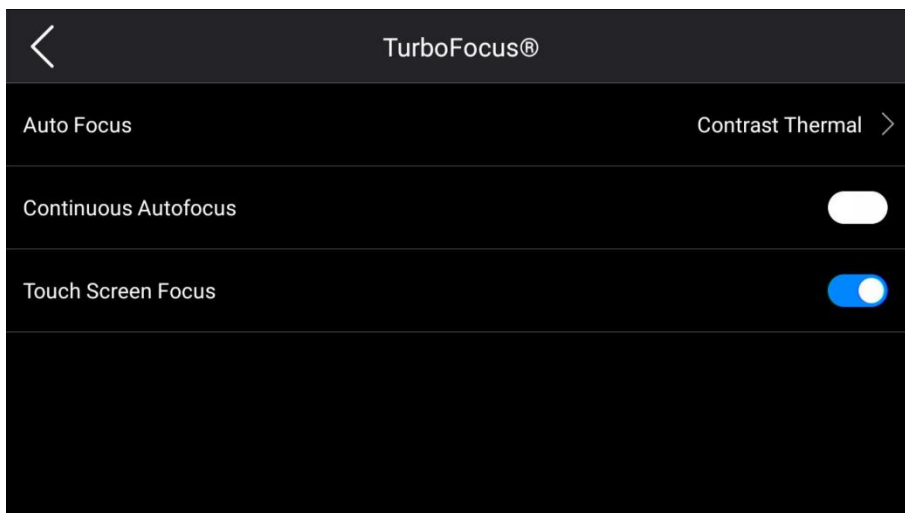



**NOTE:**

If the device is set to laser auto focus, do not aim the device at a person's face when using the auto focus or continuous auto focus function, as the laser beam may cause eye discomfort.



**NOTE:**

The focusing function on the device depends on the specific model. Please refer to the actual device for details.

### 3. IR Device Settings

Thermal settings include **Turbo Focus®**, **Overlay information**, **Manual Temperature Span adjustment Mode**, **Line Temperature distribution**, and **Measurement Enhancement**. The Measurement Enhancement is further divided into **Image Enhancement**, **Palette Extension**, and **Measurement Tools Extension**.

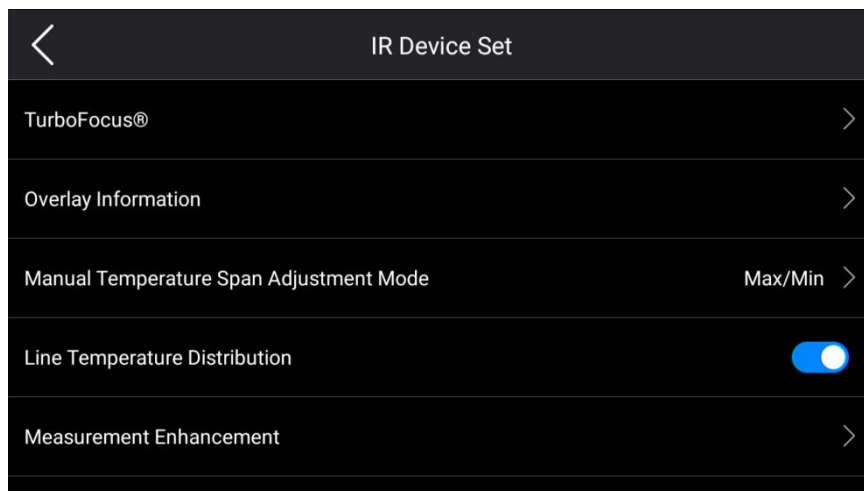

## 6. Capture Functions

---

# 1. Single Frame Capture

Capture an image in the main menu interface and save it to the device's storage card.

## Operation steps:

1. In the main menu interface, press the OK button or tap the main menu to bring up the device menu
2. **Device menu → Capture Mode → Single Frame Capture**
3. Press the shutter button to freeze the image. For operations related to freezing the image, please refer to section 5, "Freezing the Image."
4. Press the shutter button again to capture a single image

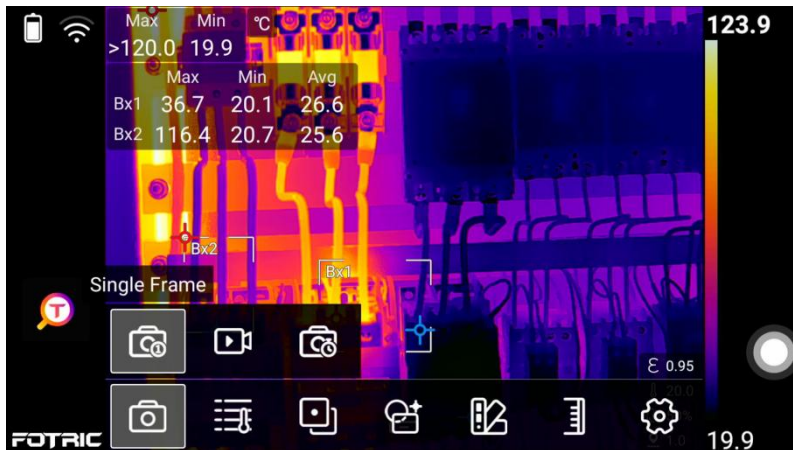

## NOTE

- To enable freeze frame before saving, follow steps 1, 2, 3, and 4
- If freeze frame before saving is not enabled, follow steps 1, 2, and 4
- To enable/disable freeze frame before saving, go to "**Settings → Storage and Save Options.->Freeze Image Before Saving**"

## 1.1 File Naming Format

### Named by Date & No.

To use a date-based serial number for naming files:

1. In the main menu interface, press the OK button or tap the main menu to bring up the device menu.
2. **Device menu → Settings → Storage and Save Options → Choose "Named by Date & No." under File naming format.**
3. Complete a single-frame capture (File name: Named by Date & No ). **Go to the gallery → Image preview → File properties, and check the file name: Named by Date & No.**

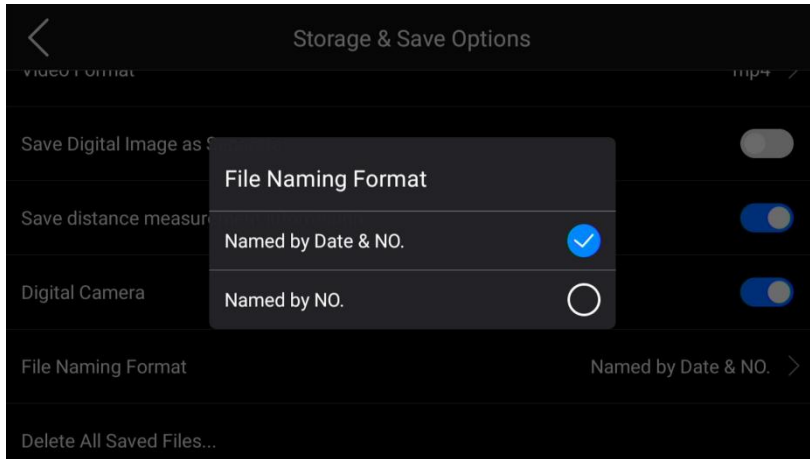

**Named by NO.**

1. In the main menu interface, press the OK button or tap the main menu to bring up the device menu.
2. **Device menu → Settings → Storage and Save Options → Choose "Named by No."** under File naming format.
3. Complete a single-frame capture (File name: Named by Date & No ). **Go to the gallery → Image preview → File properties, and check the file name: Named by No.**

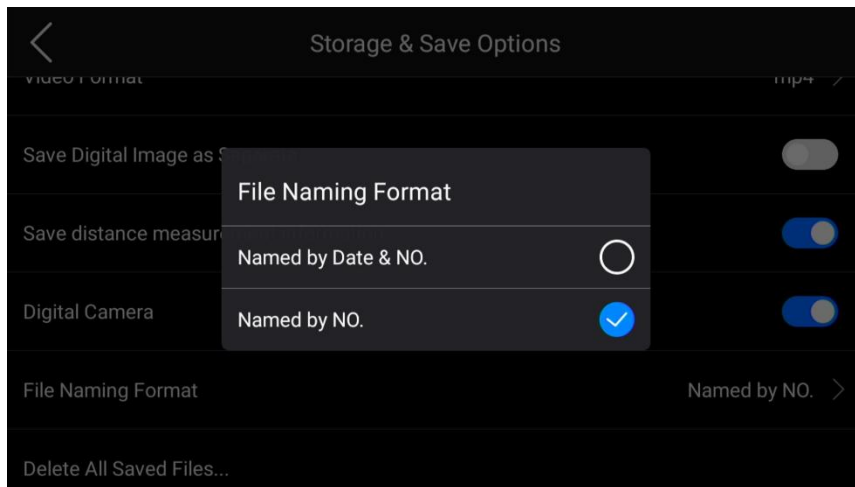

**2. Time-lapse Capture**

Set a time interval ranging from 2 seconds to 1 hour to automatically save images in infrared, T-DEF® Blend, or picture-in-picture mode, and store them on the device's memory card.

**Time-lapse Capture Operation Steps :**

1. In the main menu interface, press the OK button or tap the main menu to bring up the device menu.
2. **Device menu → Capture Mode → Time-lapse Capture.**

3. In the Time-lapse Capture menu, press OK or tap the Time-lapse Capture menu to set the time-lapse capture parameters.
4. Press the capture button to start Time-lapse capture.
5. Press the capture button again to stop the Time-lapse capture.

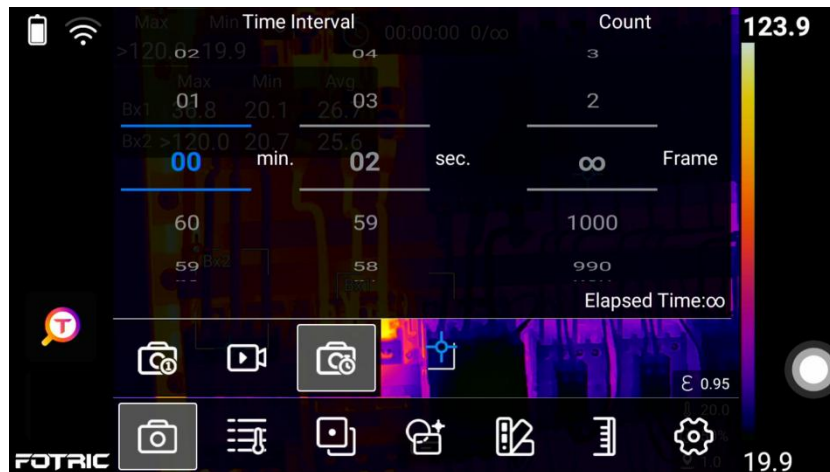

 **NOTE**

1. The Time-lapse capture mode on the device depends on the specific model, please refer to the actual device for details.

During the Time-lapse capture process, only focusing operations and stopping the Time-Lapse capture are allowed. No other operations are supported.

### 3. Video Recording

The device can record video clips and save them to the storage card, supporting IRS or IRSX, ACS, and MP4 file formats.

- **IRS or IRSX** (Radiometric video): This format is used for radiometric video and is supported only in thermal image mode.
- **ACS** (Holographic acoustic video): This format is used for holographic acoustic videos and is supported only in acoustic image mode.
- **MP4** (Standard video): This format is used for regular videos and is supported in all modes except radiometric recording.

Radiometric recording supports only thermal image mode, while holographic acoustic video recording supports only acoustic image mode. Non-radiometric recording is supported in all modes.

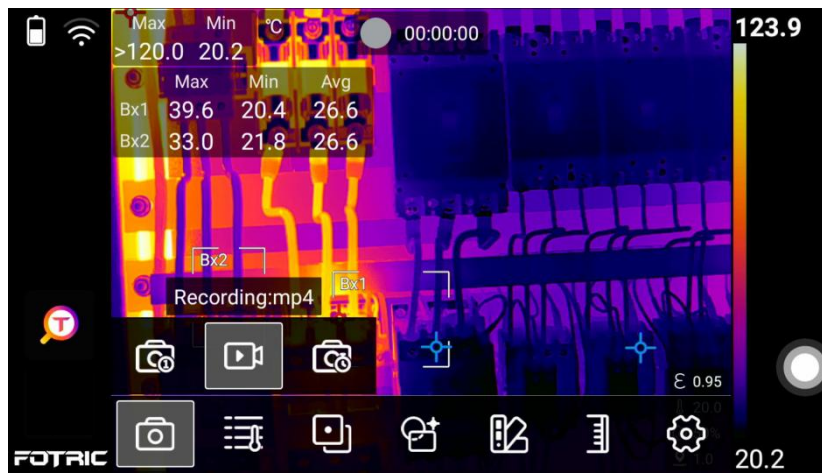

### 3.1 Radiometric Video Recording

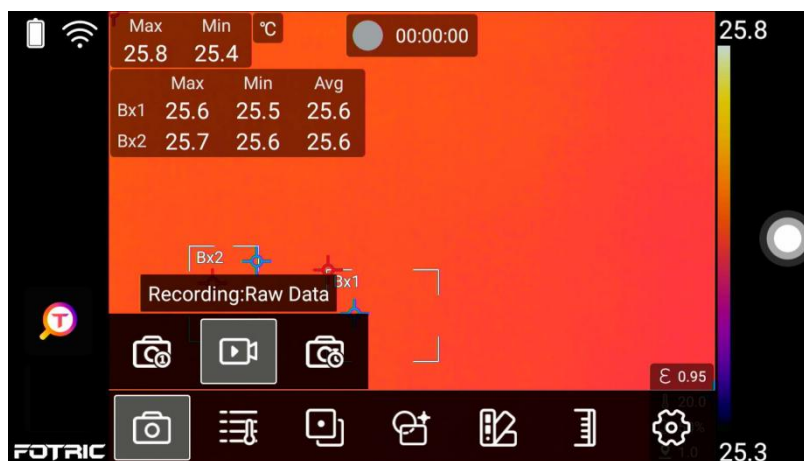

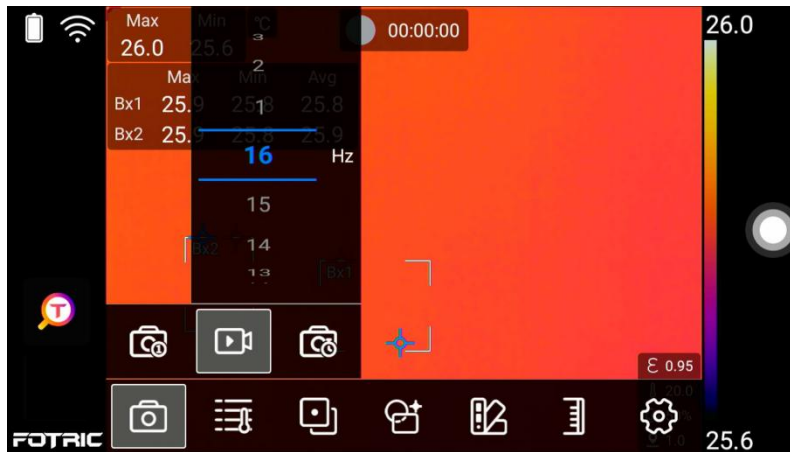

### NOTE

1. The radiometric video recording mode on the device depends on the specific model, please refer to the actual device
2. The video format selection can be set through the following path:  
**Settings → Storage and Save Options.**

## 3.2 MP4 Video Recording

Supports MP4 video recording in various image modes, and saves the video to the device's storage card.

### Operation Steps:

1. In the live interface, press the OK button or tap the main menu to bring up the device menu, then select MP4 as the video format.
2. Go to **Device Menu → Capture Mode → Recording: MP4.**
3. Press the shutter button to start recording the MP4 video.
4. Press the shutter button again to finish the MP4 video recording

### NOTE

- The MP4 video recording mode on the device depends on the specific model, so please refer to the actual device for details.
- The video format selection can be set through "Settings → Storage and Save Options."

## 3.3 Video Format

### Raw data

1. In the live interface, press the OK button or tap the main menu to bring up the device menu.
2. **In the device menu → Settings → Storage and Save Options**, select "Raw Data" for the video format.

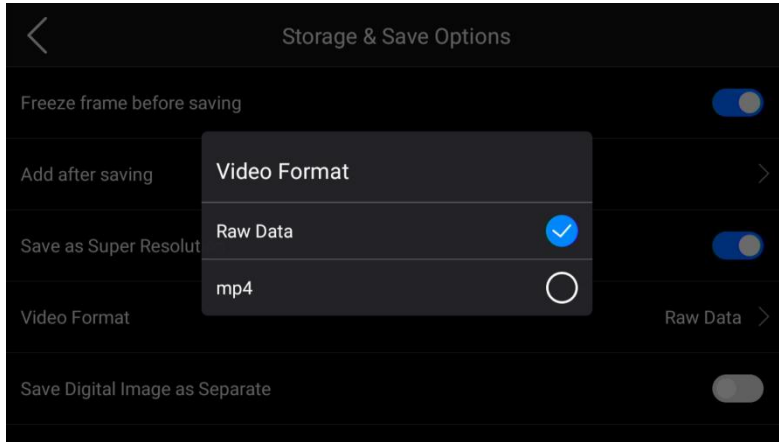

## MP4

1. In the live interface, press the OK button or tap the main menu to bring up the device menu.
2. **In the device menu → Settings → Storage and Save Options**, select "MP4" for the video format.

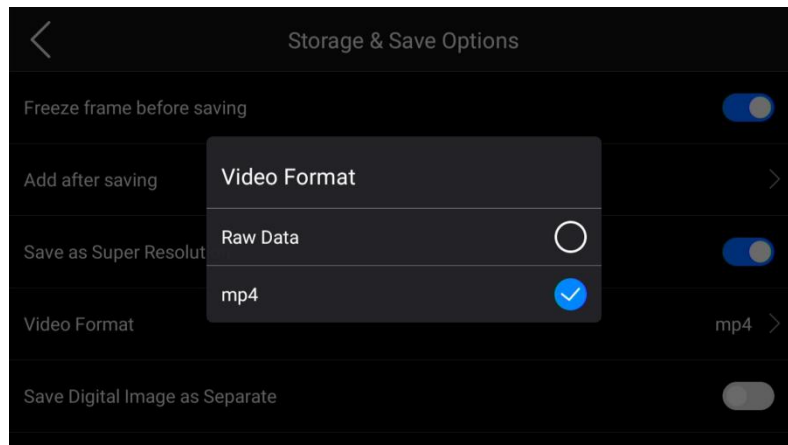

## 4. Freeze Interface

In infrared image, visible light temperature measurement (T-DEF®), and picture-in-picture modes, when taking a single frame, the freeze frame function can be enabled for preview.

**Operation Steps:** In single-frame capture mode, press the snapshot button to enter the freeze frame for the image.

---

### Temperature Measurement Parameters:

Please refer to **Thermal Imaging Measurement and Analysis** → 4.2. Global Temperature Measurement Parameters.

### Temperature Measurement Tools:

Please refer to **Thermal Imaging Measurement and Analysis** → 4.3. Measurement Tools (ROI)

### Voice Annotation:

Please refer to **Capture Functions** → 6.6 Voice Annotation.

### Text Annotation:

Please refer to **Capture Functions** → 6.7 Text Annotation.

### Tag Table

Please refer to **Capture Functions** → 6.8 Tag Table

### Favorites:

Please refer to **Capture Functions** → 6.9 Favorites

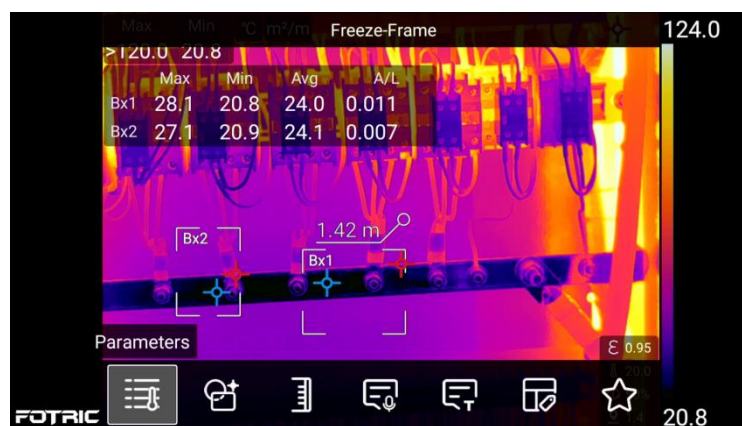

The freeze function on the device depends on the specific model. Please refer to the actual device for details.

## 5. QR Code Scan

Scan the QR code to use it as a text note and tag.

Steps for Operation:

1. Freeze the screen or preview the gallery, press the OK button or tap the main menu to bring up the device menu.
2. In the device menu, go to Text Annotation → Scan QR Code

3. Tap , and align it with the QR code to be scanned, displaying the QR code content;

4. Tap the "Save" button to successfully save the QR code content.

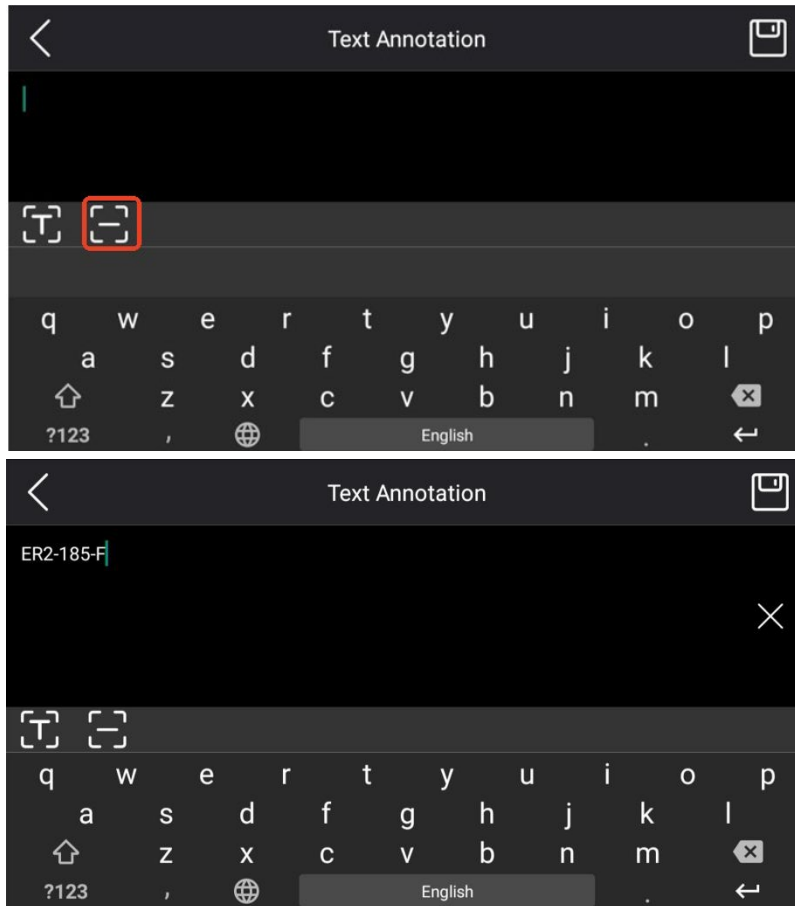



### NOTE

The QR code function on the device may vary depending on the specific model. Please refer to the actual device.

## 6. Voice Annotation

Record Voice Annotation with a maximum duration of 120 seconds and save it to the thermal image and full radiation video.

### Steps for operation:

1. Freeze the screen or preview the gallery, press the OK button or tap the main menu to bring up the device menu.
2. In the device menu, go to Voice Annotation.
3. Tap  to start recording the voice annotation.
4. Tap  to stop recording the voice annotation.
5. Tap  to play the recorded voice annotation.
6. Tap the button to delete the recorded voice annotation.

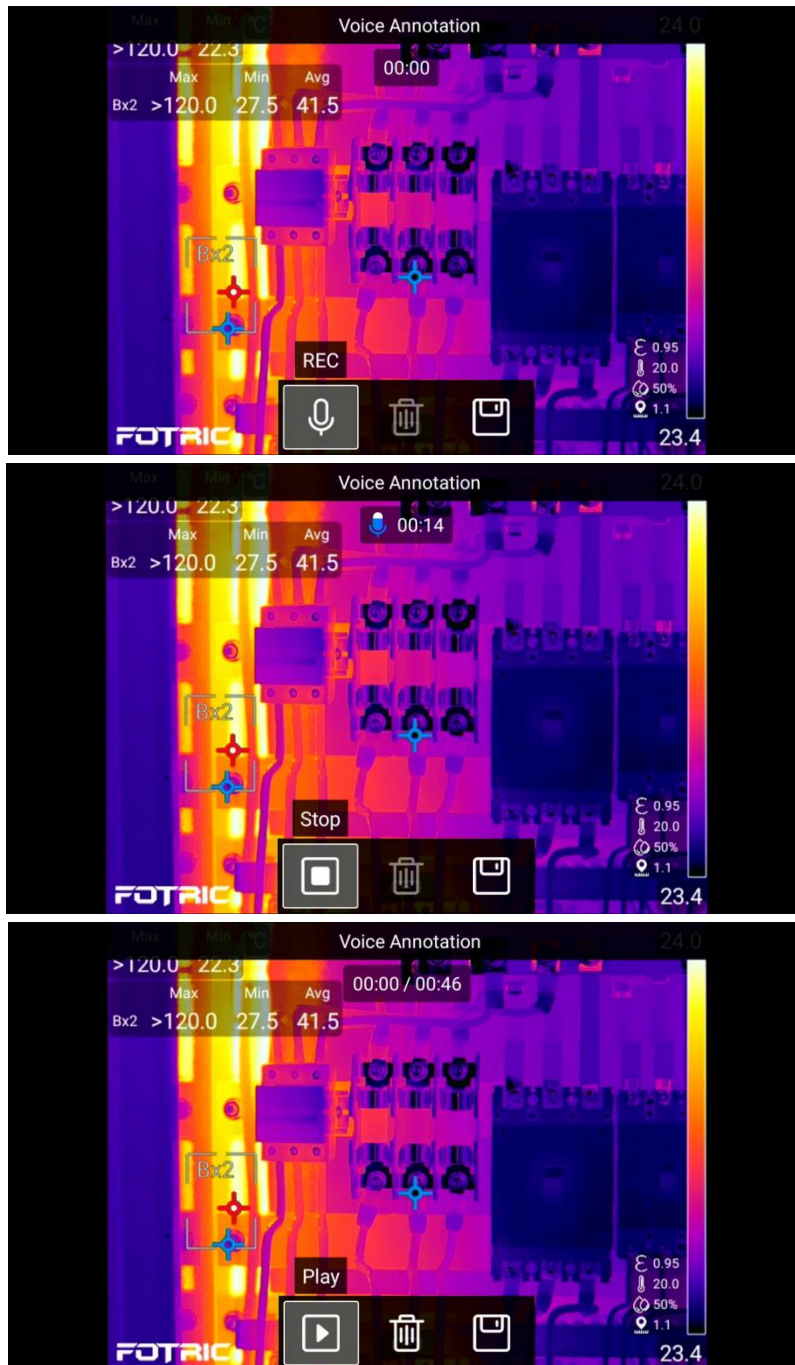

 **NOTE**

The voice annotation function on the device may vary depending on the specific model. Please refer to the actual device.

## 7. Text Annotation

### Steps for operation:

1. Freeze the screen or preview the gallery, press the **OK button** or tap the **main menu** to bring up the device menu.

2. In the device menu, go to **Text Annotation**.
3. After successfully inputting through manual keyboard entry, OCR text recognition, QR code scanning, or tap the **Save** button. The content will be saved successfully, and a text note icon will appear in the top left corner of the image.

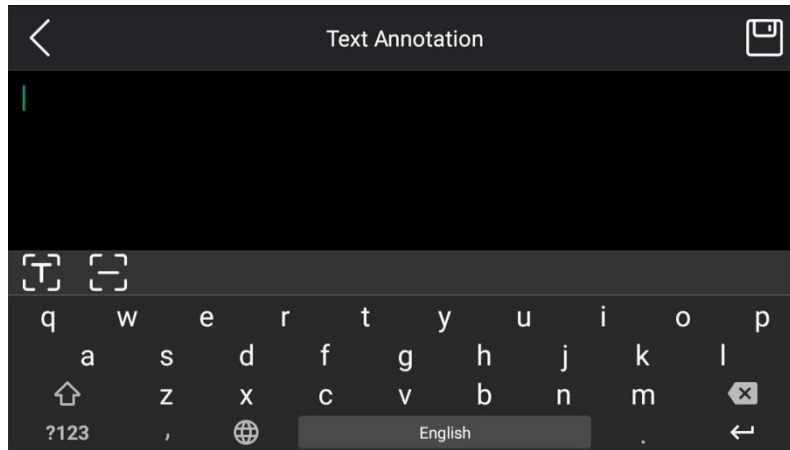

The voice note function on the device may vary depending on the specific model. Please refer to the actual device.

## 8. Tag Table

Here is the English translation of the provided instructions:

Each row in the label table can be entered through a dropdown list or soft keyboard input, saved to a file, and then filtered by label values in the gallery. The specific steps are as follows:

1. Freeze the screen/gallery preview, press the OK button or touch the main menu to bring up the device menu.
2. **Device menu** → **Tag Table**

 A screenshot of a mobile application interface titled "Default". At the top, there is a back arrow on the left and three icons (pencil, printer, and list) on the right. Below the title bar is a table with five rows. Each row has a label on the left and a dropdown arrow on the right. The labels are: Location, Sub-location, Target, Target ID, and Inspected.
 

Default	
Location	▼
Sub-location	▼
Target	▼
Target ID	▼
Inspected	▼

- As shown in the image, the left side represents the field name, and the right side represents the field value. The field value can be selected from a dropdown list or entered as text. For example, in the image, select the dropdown option "Company A," then change it to "Company AA." Afterward, click the button to add "Company AA" to the dropdown options.

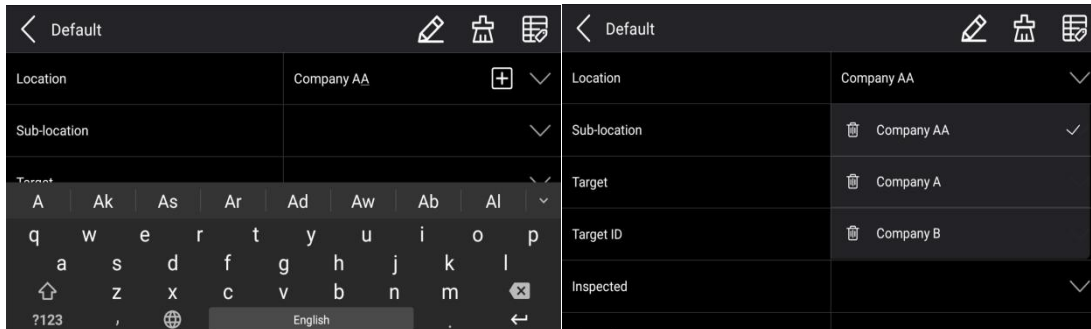

- Press the back button and select "Save table" to complete the addition of the Tag table.



Function: Clicking this button will enable editing field names, allowing the user to add, modify, and delete them. After editing, click the button again to save the changes.

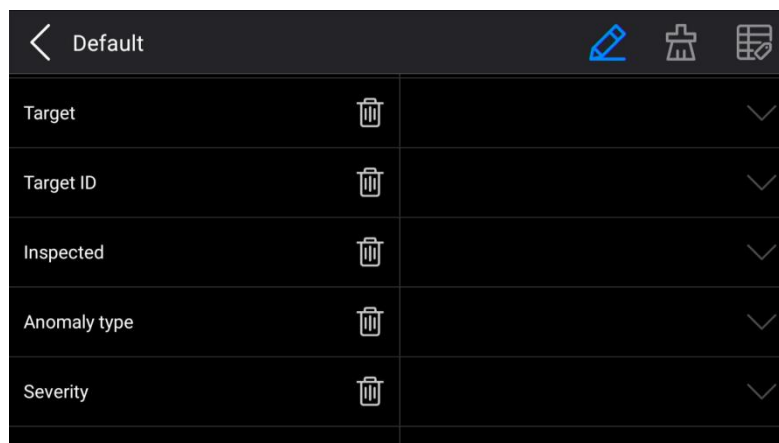

Function: Clicking this button will clear all field values.



Function: Clicking this button allows you to switch between different table templates. To do this, create a new folder called "TagTable" on the device's storage card, and import the custom label templates from the PC software. Then, the user can select different table templates on the device.

- Default** is the default label table that comes with the device.
- Tag Template 1** is a user-customized label template.

Default	
Location	Default ✓
Sub-location	Tag Table 1
Target	✓
Target ID	✓
Inspected	✓

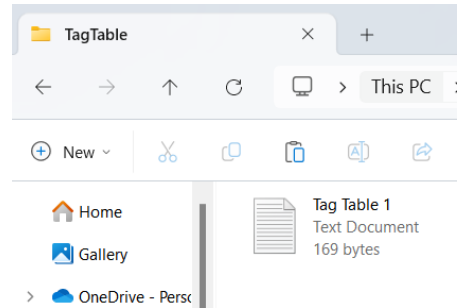

**Sorting Function:** When you press and hold a row, the following status will appear, allowing you to drag it to a suitable position above or below for sorting.

Default		Default	
Location	CompanyAA ✓	Location	CompanyAA ✓
Sub-location	✓	Sub-location	✓
Target	✓	Target ID	✓
Target ID	Target ✓	Target	✓
Inspected	✓	Inspected	✓



The label function on the device depends on the specific model; please refer to the actual device for details.

## 9. Favorites

### Operation Steps:

1. Freeze the screen/gallery preview, press the OK button or touch the main menu to bring up the device menu.
2. **Device menu** → **Favorites**
3. Press the OK button or touch the favorite icon, and the favorite icon will appear in the top-left corner of the image.

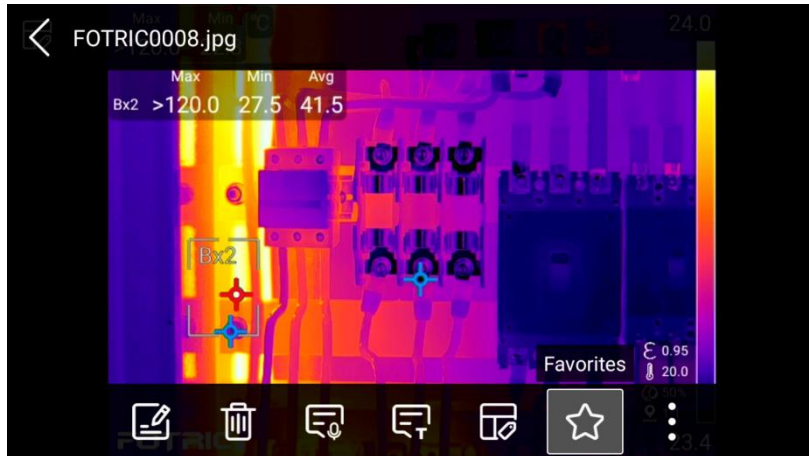

## NOTE

The collection function on the device depends on the specific model; please refer to the actual device for details.

## 10. Sketch

Make sketched by dragging your finger on the display screen and save it to the thermal image.

### Operation steps:

1. Enter the sketch interface through the Add after saving/Gallery preview interface...
2. Select the graffiti pen of the corresponding color as needed to draw;
3. Select the eraser to erase the excess graffiti part, click the Save button, and the sketch is successfully saved to the thermal image.

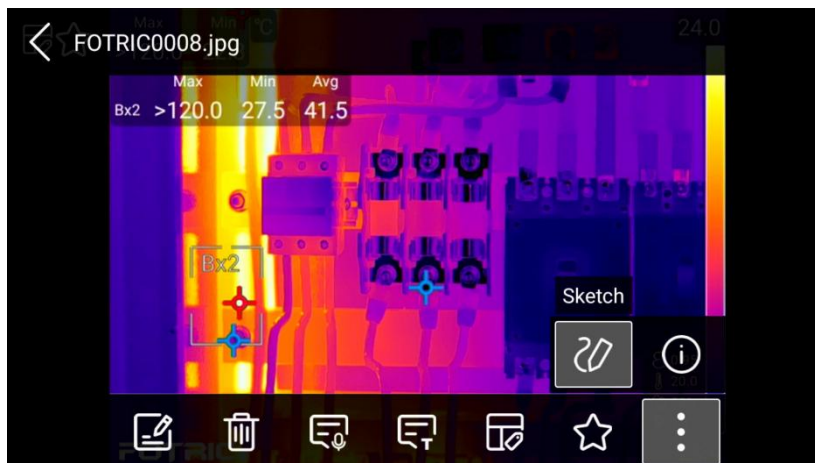

## 11. Gallery

The files are saved on the SD storage card, and the user can view all the saved files through the gallery.

### Operation Steps:

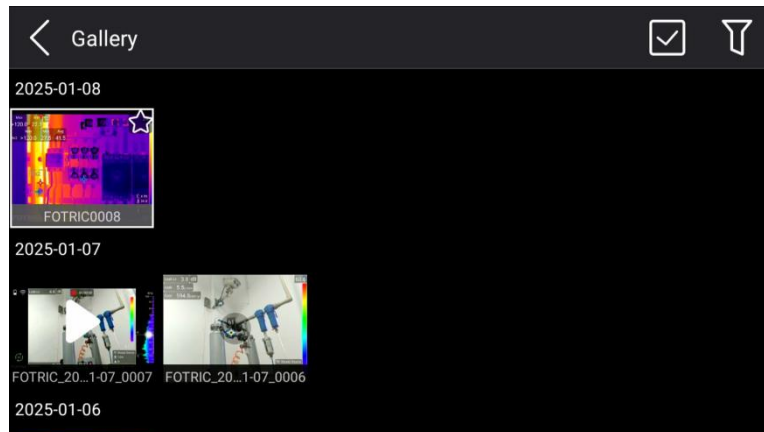

1. Press the Gallery button on the device to enter the gallery interface.

- 
2. Press the Back button on the device to return to the live view interface.



## Generate Report: 9.12 On-device Report

### Delete

- Click the selection icon /button at the top of the gallery, or press the selection icon  at the top and then press the OK button.
- Select one or more files, then click the delete icon/button at the top of the gallery, or press the delete icon at the top and then press the OK button.
- Click the confirm button to successfully delete the selected files

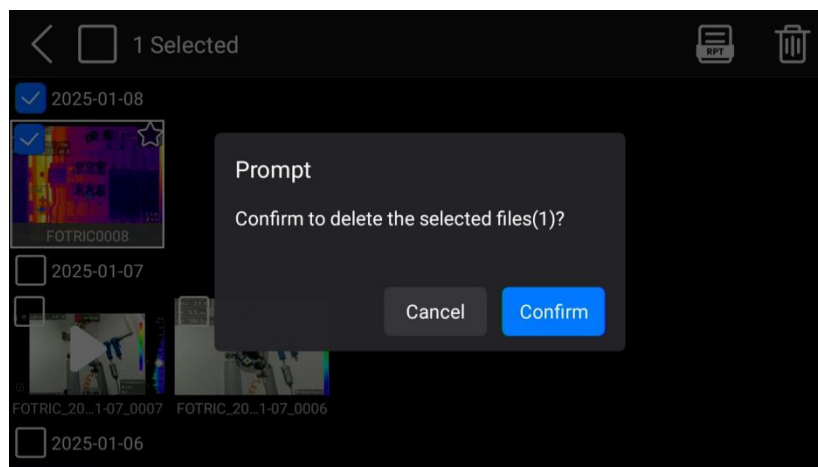

### Filtering

- Click the filter icon/button at the top of the gallery, or press the filter icon at the top and then press the OK button.
- Select "Favorites" to successfully filter out the files marked as favorites.
- Select "IR" to successfully filter out the files taken with the thermal imager.
- Select "AC" to successfully filter out the files taken with the thermal imager.
- Select a specific tag to successfully filter out the files with that tag.

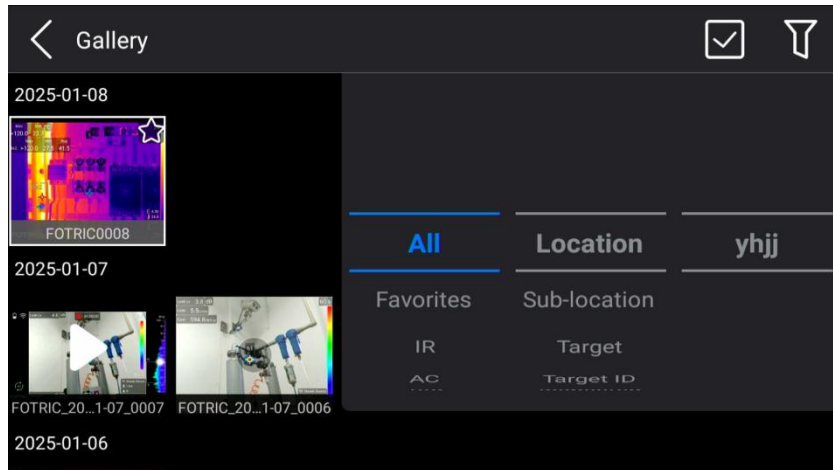

### Gallery Preview

The thermal image has been selected. Touch the thermal image or press the OK button to enter the gallery preview interface



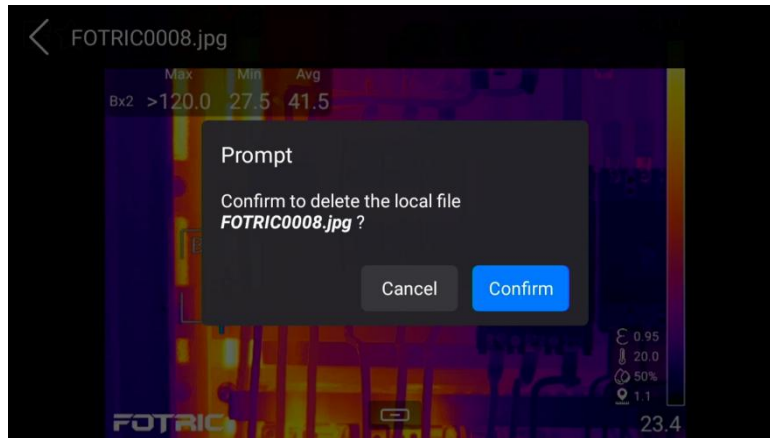

### Delete Function:

Click the delete button, and the image or video will be successfully deleted



 Voice Annotation: 6.6 Voice Annotation.

 Text Annotation: 6.7 Text Annotation.

 Tag Table: 6.8 Tag Table

 Favorites: 6.9 Favorites

## 12. On-device Report

Support the generation of Word or PDF reports from single or multiple thermal images.

Operating Steps:

1. Click the selection icon above the gallery  / Press the key to directly reach the selection icon

 above, then press the OK key;

2. Select one or more thermal images, click the 'Generate Report' icon above the gallery / Press the key to directly reach the 'Generate Report' icon above, then press the OK key;

3. Select the report format: docx, tap / press the OK key to successfully generate a .docx report for the selected thermal image.;

4. Select the report format: pdf, tap / press the OK key to successfully generate a .pdf report for the selected thermal image.

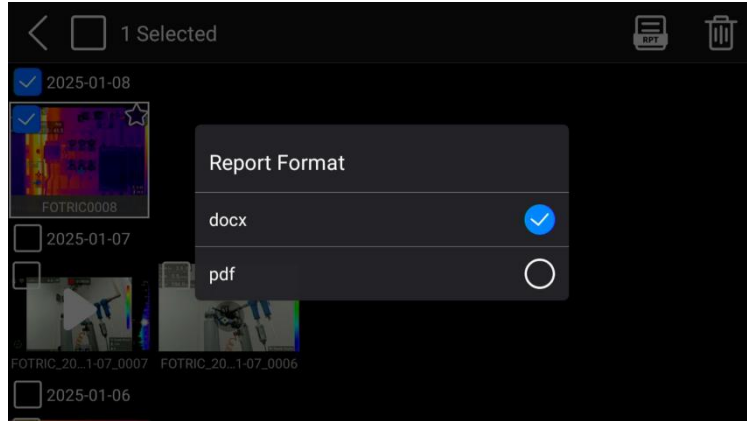

The built-in report function on the device may vary depending on the specific model. Please refer to the actual device.

## 7. Plug-ins

### 1. NaviPdM Venus

For detailed instructions, please refer to the user manual of this featured function

## 8. Connection

### 1. WiFi Connection

Use Wi-Fi to connect the device to a wireless local area network (WLAN).

#### Steps:

1. On the main menu interface, press the OK button or tap the main menu to bring up the device menu.
2. Go to **Device Menu** → **Settings** → **Connection** → **WLAN**.
3. Enable the wireless network, which will display a list of available networks. Select a network.
4. Choose one of the available networks. Networks with password protection will be indicated by a padlock icon. To access these networks, enter the password and click the "**Join**" button. The wireless network will be successfully connected.

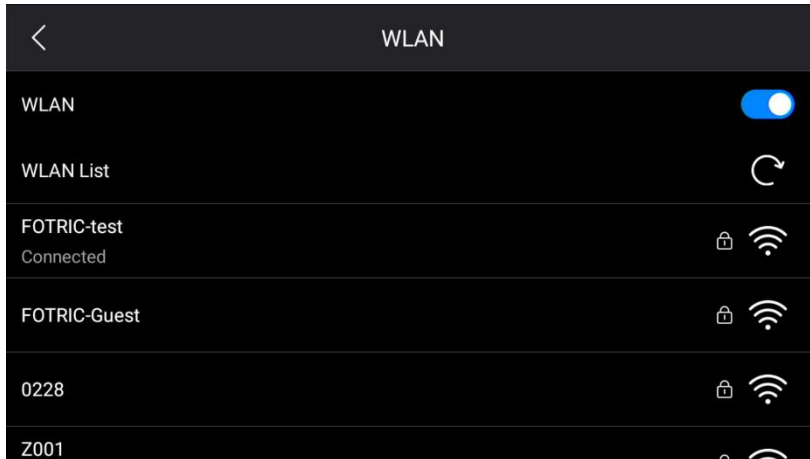

The Wi-Fi connection function on the device depends on the specific model. Please refer to the actual device for details.

## 2. Bluetooth

### Bluetooth Connection

After enabling Bluetooth, the user can search for nearby Bluetooth headphones for pairing. Once paired successfully, the user can listen to the recorded voice in the thermal image and radiometric video through the Bluetooth headphones.

#### Steps:

1. On the main menu interface, press the OK button or tap the main menu to bring up the device menu.
2. Go to **Device Menu** → **Settings** → **Connection** → **Bluetooth**.
3. Enable Bluetooth connection, which will display a list of available Bluetooth headphones.
4. Select an available Bluetooth headphone to connect. Once the Bluetooth connection is successful, the status will change to "Connected."

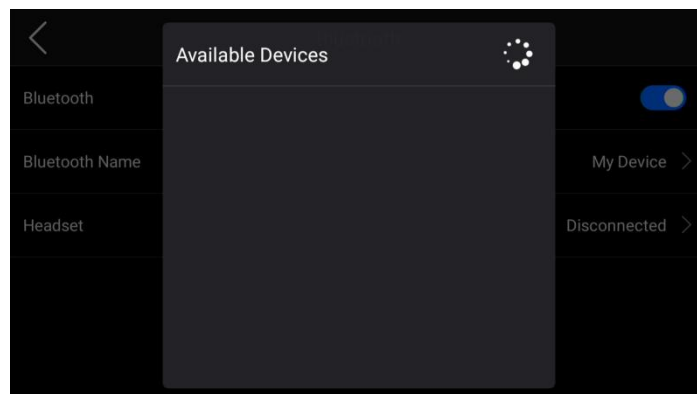

- 
- Bluetooth connection function depends on the specific model. Refer to the actual device for details.
  - After adding a Bluetooth headphone, it can be used to add voice annotations.
  - Once a Bluetooth headphone is added, the built-in microphone and speaker are automatically disabled.

### 3. USB Interface

#### USB Interface

The device can be connected to a computer using a USB cable. Once the connection is established, image and video files can be transferred from the storage card to the computer.

### 4. HDMI Interface

Use the device-compatible HDMI cable to connect the device to the computer. The device's interface image will be synchronized and displayed on the computer screen.

### 5. FTP

Connect to the device via WiFi network or the device's own WiFi hotspot, then access the data on the device through FTP.

#### Operation steps:

1. On the main menu interface, press the OK button or tap the main menu to bring up the device menu.
2. **Device menu** → **Settings** → **Connection** → **More Connection** → **FTP** .
3. Enable FTP Quick Transfer, and use a client browser, file manager, or FTP client tool to enter the FTP address: ftp://IP:port/ to connect to the thermal imaging device's FTP service and perform file transfer.
4. The user can configure whether to allow anonymous access. If anonymous access is enabled, the client does not need to authenticate and can connect to the device's FTP service to operate the file system.
5. If anonymous access is disabled, the client needs to enter the configured username and password to access the file system.

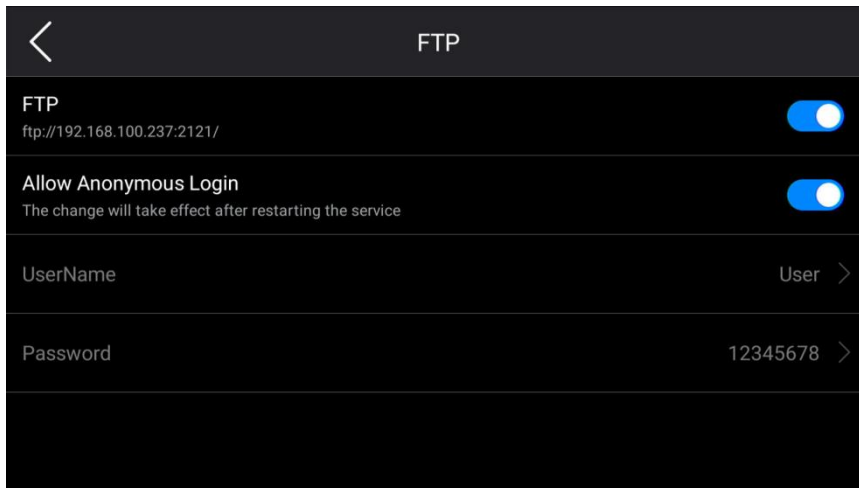

- The FTP quick transfer function on the device depends on the specific model. Please refer to the actual device for details.
- In WLAN mode, the client must connect to the same WLAN network.
- In hotspot mode, the client must first connect to the device's hotspot before it can be accessed

## 6. PC Radiometric Video Stream

PC radiometric video stream can be analyzed in real-time through AnalyzIR. For specific operation steps, please refer to the user manual of the analysis software.

## 7. Remote Display

Radiometric video stream can be viewed via the USB Type-C interface connected to AnalyzIR, while the HDMI interface can be used to connect to a display or projector. For detailed instructions, please refer to the corresponding user manual.

# 9. Remote Control

## 1. PC Control

AnalyzIR supports installation on Windows systems, allowing you to connect devices for real-time data analysis and view and analyze the captured and recorded data. For detailed instructions, please refer to the user manual of the analysis software.



The desktop control functionality depends on the specific model. Please refer to the actual device

---

for details.

## 2. Mobile Device Control

The mobile software EasyIR is available on Android systems, allowing users to preview the device's screen, synchronize device data, and view, browse, share, and analyze the synchronized data. For detailed instructions, please refer to the user manual for the mobile app.

## 3. Webpage Control

Remote operation control can be performed through the browser of devices such as mobile phones, computers, and tablets, allowing you to access, analyze, and share local data. For detailed instructions on the web-based control, please refer to the user manual for the web interface.

The device's IRExplorer page displays the web link, editable username, password, and the scanned QR code.

### Steps:

- Press the OK button or tap the main menu to bring up the device menu.
- **Device menu → Settings → Connections → More Connections → IRExplorer.**
- Enter the IP address on a computer or mobile device to access the IRExplorer login page.
- Log in using a username and password, or directly access the login page by scanning the QR code.



**NOTE**

The availability of web-based control varies by model.

# 10. Auxiliary Functions

## 1. Intelligent Focusing System (TurboFocus®)

The intelligent focusing system supports Contrast Thermal Focus, Laser Focus, Continuous Autofocus, and Touch Screen Focus.

### Contrast Thermal Focus:

- In the main menu interface, press the OK button or tap the main menu to bring up the device menu.
- **Device menu → Settings → IR Device Set → TurboFocus® → Select Contrast Thermal Focus for autofocus.**
- Return to the main menu interface, press the focus button to perform autofocus based on the optimal contrast of the image.

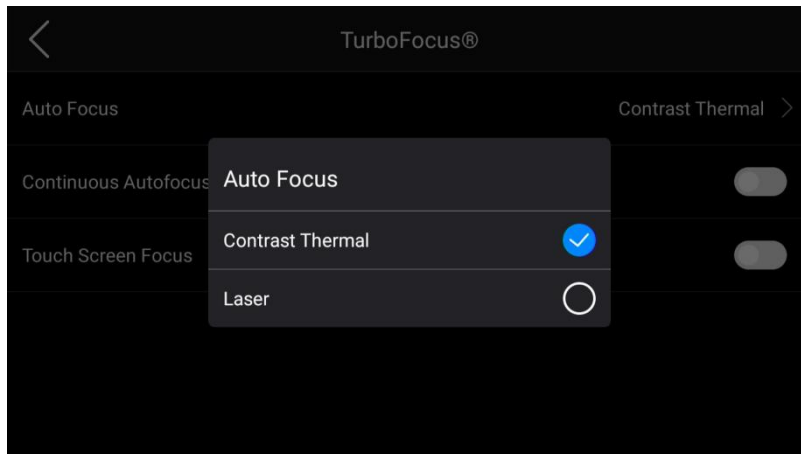

**Laser Focus:**

- In the main menu interface, press the OK key or touch the main menu to bring up the device menu.
- **Device menu → Settings → IR Device Set → TurboFocus® → Select Laser Focus** for automatic focus.
- Return to the main menu interface, press the focus button, and the automatic focus will be performed based on the distance between the measurement imager and the target.

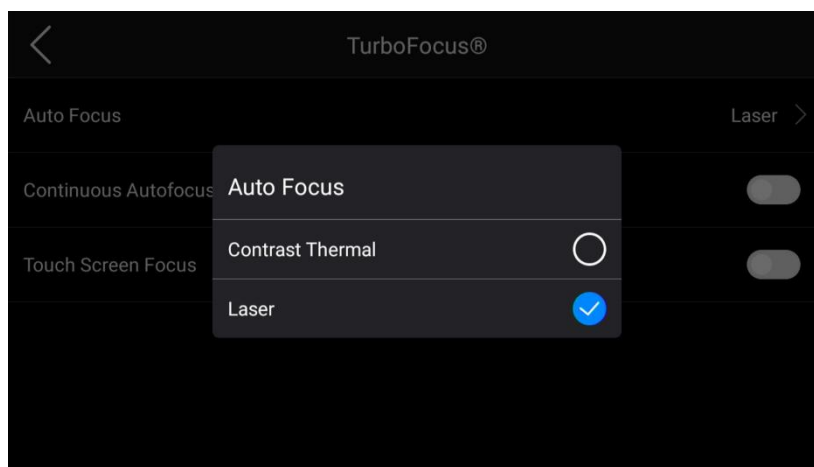

**Continuous Autofocus:**

- In the main menu interface, press the OK key or touch the main menu to bring up the device menu.
- **Device menu → Settings → IR Device Set → TurboFocus® → Enable Continuous Autofocus.**
- Return to the main menu interface. After the device moves and then stops, the continuous automatic focus adjustment will be performed based on the Thermal contrast or laser distance measurement method, depending on the different distances of the measured objects in the scene.



The **TurboFocus®** intelligent focusing system on the device is dependent on the specific model. Please refer to the actual device for details.

#### **Touch Screen Focus**

- In the main menu interface, press the OK key or touch the main menu to bring up the device menu.
- **Device menu** → **Settings** → **IR Device Set** → **TurboFocus®** → Enable **Continuous Autofocus**.
- Return to the main menu interface. After the device moves and then stops, the continuous automatic focus adjustment will be performed based on the image contrast or laser distance measurement method, depending on the different distances of the measured objects in the scene.



The touch focus function on the device is available depending on the specific model. Please refer to the actual device for confirmation

---

## 2. Floating Ball

The floating ball enables virtual button functions to call up features such as photo capture, lighting, AI, and gallery physical buttons.

### Steps:

1. On the live interface, press the OK button or tap the main menu to bring up the device menu.
2. **Device menu → Settings → Device Set → Floating Ball.**
3. After enabling, the floating ball button will appear on the live interface and can be moved to any position.
4. Tap the floating ball button to expand the sub-functions. Tap again to collapse the sub-functions of the floating ball.

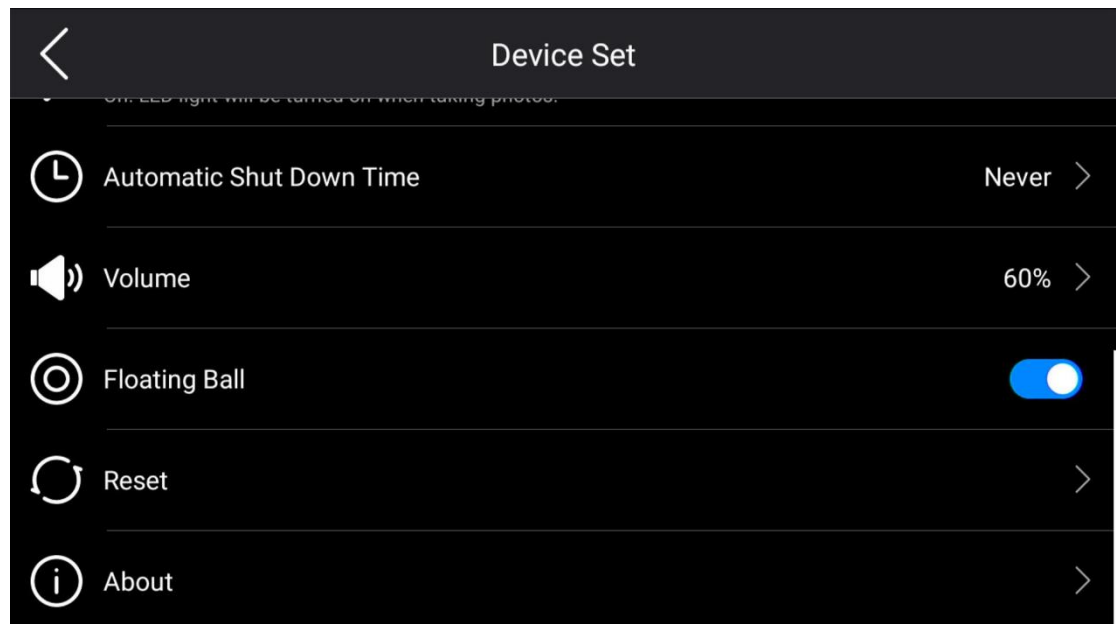

## 3. Laser

Supports **Laser Pointer** and **Laser Distance Measurement**.

### Operation Steps:

1. Press the laser button on the device to turn on the laser.
2. A laser point will be visible on the target, and the screen will display the symbol  along with the laser measurement distance.
3. Release the laser button to turn off the laser.



The laser distance measurement function on the device is available depending on the specific model. Please refer to the actual device for confirmation.

## 4. Region Feature Measurement

Support temperature measurement along the measurement line length and support temperature measurement for rectangular and circular areas.

### Temperature Line Length Measurement:

1. Add a temperature measurement line on the real-time screen.
2. Ensure the temperature measurement line is centered on the image.
3. Adjust the length of the temperature measurement line to match the size of the target.
4. Keep the device perpendicular to the target and press the laser button on the device.
5. The calculated length will be displayed on the real-time screen.

### Temperature Frame Rectangle and Circle Area Measurement:

1. Add a temperature measurement frame rectangle and a temperature measurement frame circle on the real-time screen.
2. Ensure the temperature measurement frame rectangle or temperature measurement frame circle is centered on the image.
3. Adjust the size of the temperature measurement frame rectangle or temperature measurement frame circle to match the size of the target.
4. Keep the device perpendicular to the target and press the laser button on the device.
5. The calculated area will be displayed on the real-time screen.



### NOTE

The region feature measurement function on the device depends on the specific model. Please refer to the actual device for details

## 5. GPS

Supports GPS satellite positioning.

### Operation Steps:

1. On the main menu interface, press the OK button/tap the main menu to bring up the device menu.
2. Device menu → Settings → Device Settings → Location Information → Geolocation.
3. Turn on Geolocation, and location information can be saved to a file.

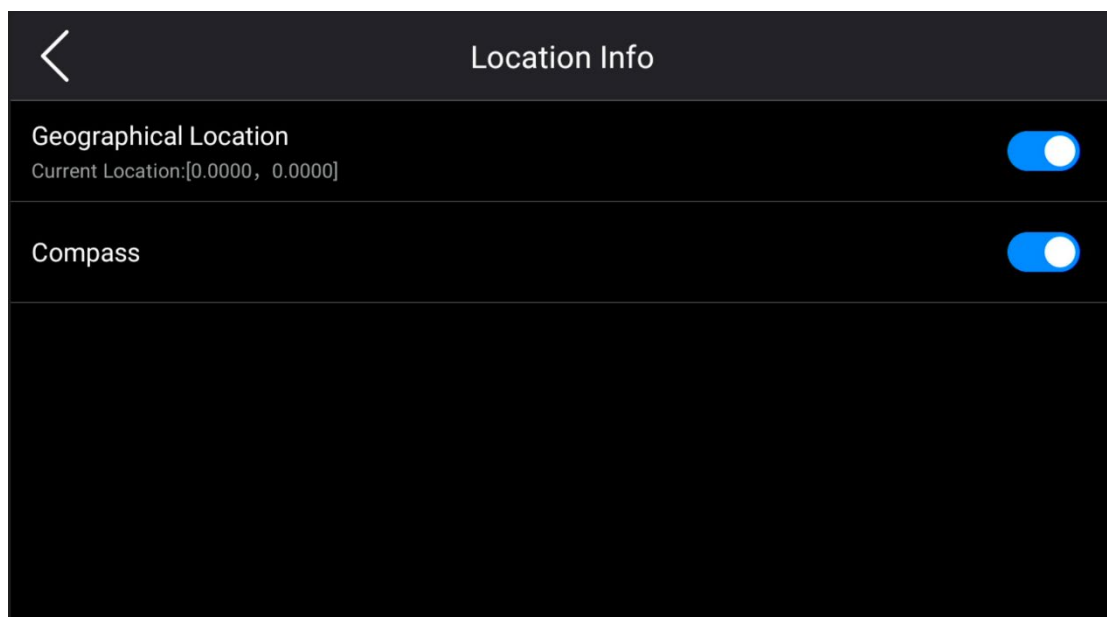



**NOTE**

The geolocation function on the device depends on the specific model. Please refer to the actual device.

## 6. Compass

Support 360° orientation

Operation steps:

1. In the main menu interface, press the OK button or touch the main menu to bring up the device menu.
2. **Device menu → Settings → Device Settings → Location Information → Compass.**
3. Turn on the compass, and the orientation information can be saved to the thermal image and radiometric video.
4. **Device menu → Settings → Thermal Image Settings → Image Overlay Information → Enable Compass.**
5. Return to the main menu interface, and the orientation information will be displayed in the image overlay section at the bottom right of the main menu interface.

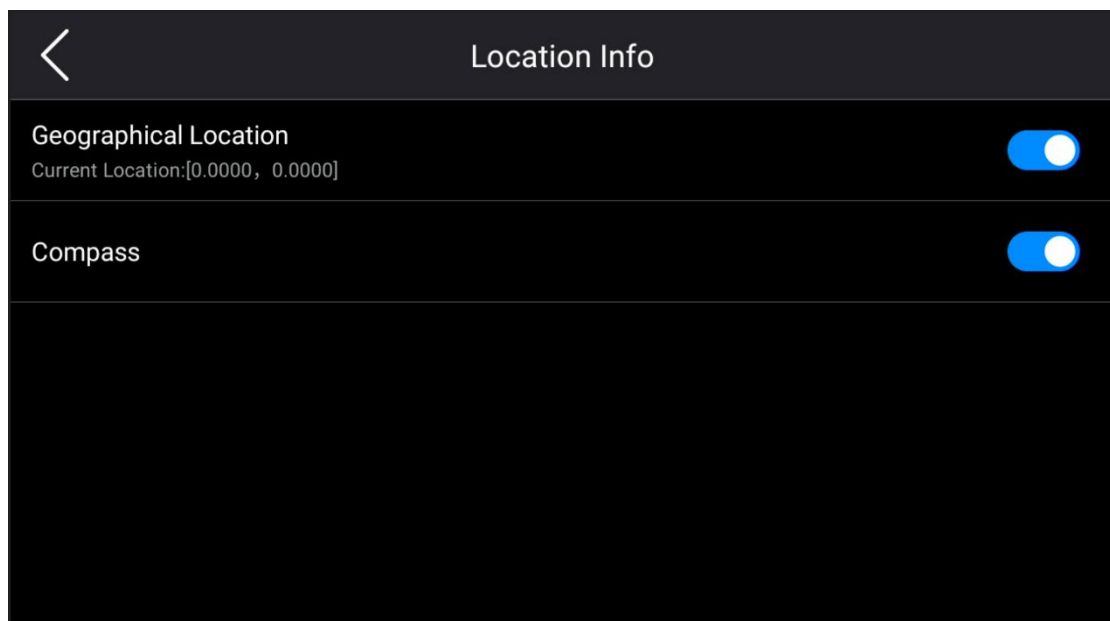

## 7. LED Lamp

Support for **Flashlight illumination** and **Flash mode**.

**Flashlight Illumination:**

Open the device's flashlight from the main menu interface drop-down menu and use it as a flashlight.

**Flash Mode:**

1. In the main menu interface, press the OK button or touch the main menu to bring up the device menu.
2. **Device menu → Settings → Device Settings → LED light as flash.**
3. Once enabled, the LED light will function as a flash when pressing the shutter button for single-frame capture, or the LED light will continuously function as a flash during timed continuous capture for image saving.

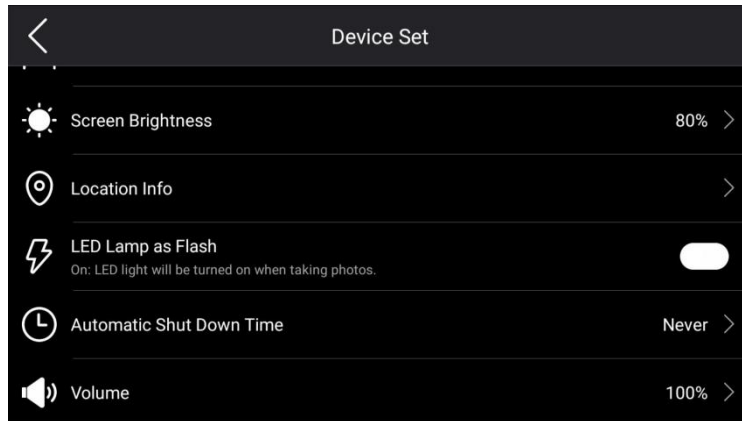

## 8. Language

The supported languages include: Simplified Chinese, English, Traditional Chinese, Spanish, Korean, German, Portuguese, Italian, French, and Thai.

Operation steps:

1. In the main menu interface, press the OK button or touch the main menu to bring up the device menu.
2. **Device menu → Settings → Device Settings → Language&Time&Region → Language.**
3. The default languages are Simplified Chinese and English. Select a language to switch to that language.

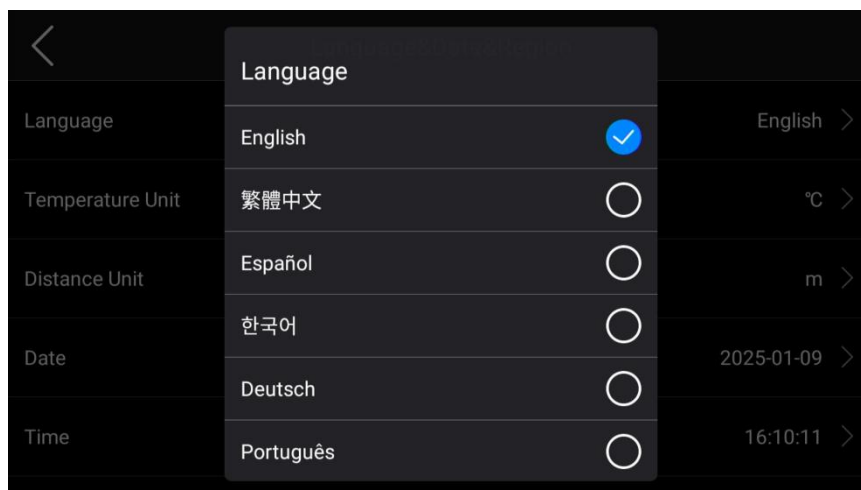



**NOTE**

The default language on the device depends on the specific model. Please refer to the actual device for confirmation.

## 9. Software and Firmware Upgrades

Supports online software upgrades, offline upgrades, and system configuration online and offline upgrades.

### Online Software Upgrade:

1. On the main menu interface, press the OK button/touch the main menu to bring up the device menu.
2. **Device Menu** → **Settings** → **Device Set** → **About** → **System Update**.
3. Ensure WIFI is enabled, the device is connected, and the network is stable.
4. Agree to the user agreement and click "Software Update."
5. Click "**Online Upgrade**," and the available upgrade version will be detected.
6. Click the upgrade button, and the system will proceed with the upgrade. After the upgrade is complete, the device will restart, and the software version will be updated to the successfully upgraded version.

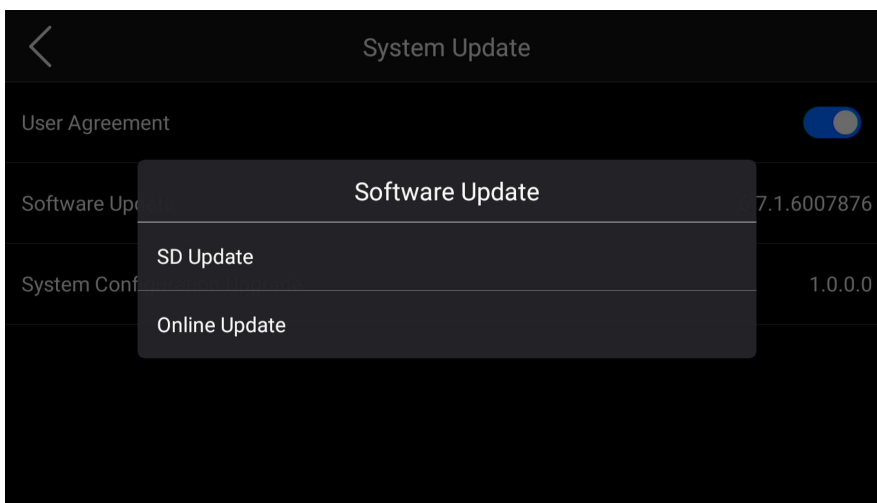

### Offline Software Upgrade:

- The upgrade package (.epk file) has been placed in the device's storage card in the corresponding "update" folder.
- On the main menu interface, press the OK button/touch the main menu to bring up the device menu.
- **Device Menu** → **Settings** → **Device Set** → **About** → **System Update**
- Agree to the user agreement and click "**System update**."
- Click "**SD Update**," and a QR code scanning interface will appear.

- 
- Use smartphone to scan the QR code. After the upgrade verification is successful, a verification code will be displayed. Enter the code in the device's QR code interface to proceed with the upgrade. Once the upgrade is completed, the device will restart, and the software version will be updated to the successfully upgraded version.

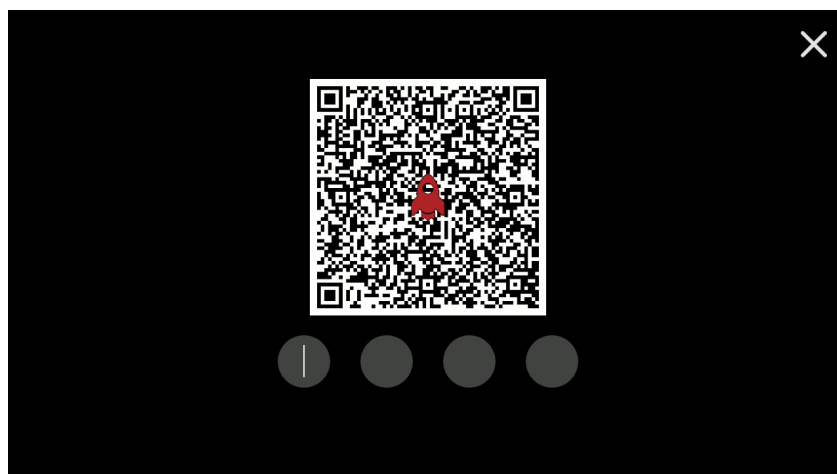

### **Online System Configuration Upgrade:**

- Ensure WIFI is enabled, the device is connected, and the network is stable.
- On the main menu interface, press the OK button/touch the main menu to bring up the device menu.
- Device Menu → Settings → Device Set → About → System Update.
- Agree to the user agreement and click "System Configuration Upgrade."
- Click "Online Update," and the available upgrade version will be detected.
- Click the upgrade button, and the system will proceed with the upgrade. After the upgrade is complete, the device will restart, and the system configuration version will be updated to the successfully upgraded version.

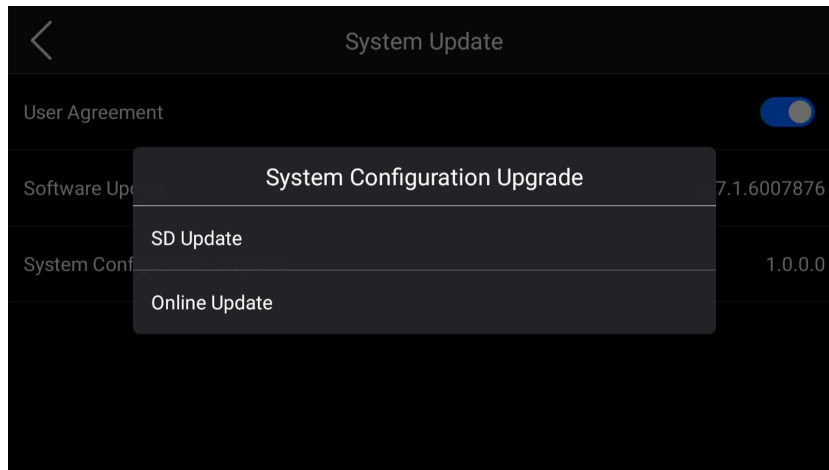

### Offline System Configuration Upgrade:

- The upgrade package (.epk file) has been placed in the device's storage card in the corresponding "update" folder.
- On the main menu interface, press the OK button/touch the main menu to bring up the device menu.
- Device Menu → Settings → Device Settings → Device Information → System Upgrade.
- Agree to the user agreement and click "System Configuration Upgrade."
- Click "SD Update" and a QR code scanning interface will appear.
- Use a smartphone to scan the QR code. After the upgrade verification is successful, a verification code will be displayed. Enter the code in the device's QR code interface to proceed with the upgrade. Once the upgrade is completed, the device will restart, and the device configuration version will be updated to the successfully upgraded version.



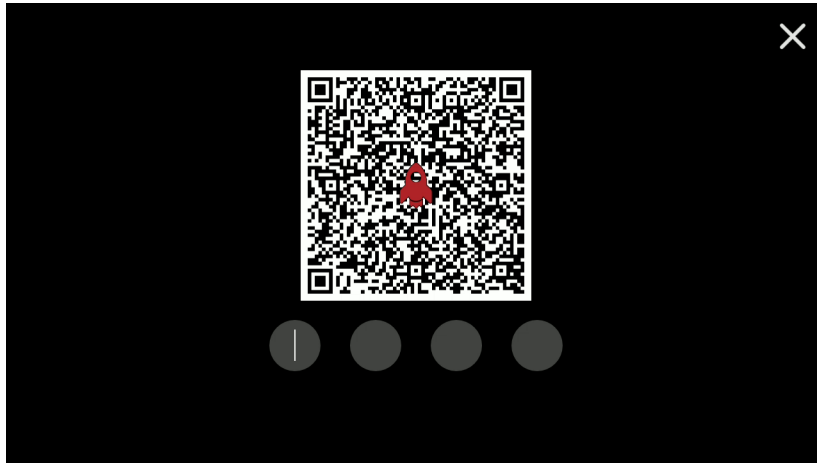

## 10. Device Set

Set the language, time, and region, USB mode, screen brightness, location information, LED light as flashlight, auto shutdown time, volume, reset, and view device information.

**Language&Time&Region Settings:** Set language, Temperature Unit, Distance Unit, Date, Time, Time Zone, and Date Format.

Language&Date&Region	
Language	English >
Temperature Unit	°C >
Distance Unit	m >
Date	2025-01-09 >
Time	16:57:39 >
Time Zone	GMT+08:00 Asia/Shanghai >
Date Format	yyyy-mm-dd >

---

**Language Setting:** Refer to section 12.8 Supported Languages.

**Set Temperature Unit:**

1. On the main menu interface, press the OK button/touch the main menu to bring up the device menu.
2. **Device Menu** → **Settings** → **Device Set** → **Language&Time&Region** → **Temperature Unit**.
3. Set the temperature unit parameter.

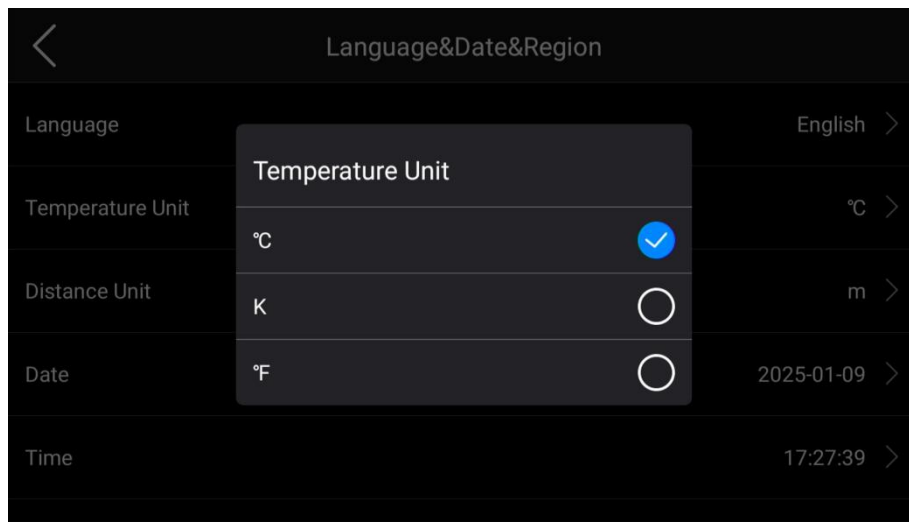

**Set Distance Unit:**

1. On the main menu interface, press the OK button/touch the main menu to bring up the device menu.
2. **Device Menu** → **Settings** → **Device Set** → **Language&Time&and Region** → **Distance Unit**.
3. Set the distance unit parameter.

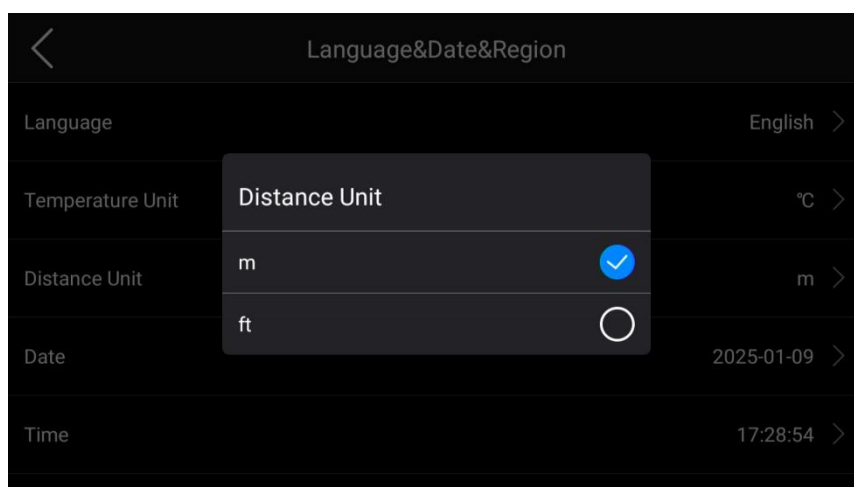

**Set Date:**

1. On the main menu interface, press the OK button/touch the main menu to bring up the device menu.
2. **Device Menu → Settings → Device Set → Language&Time&Region → Date**
3. Set the date parameter.

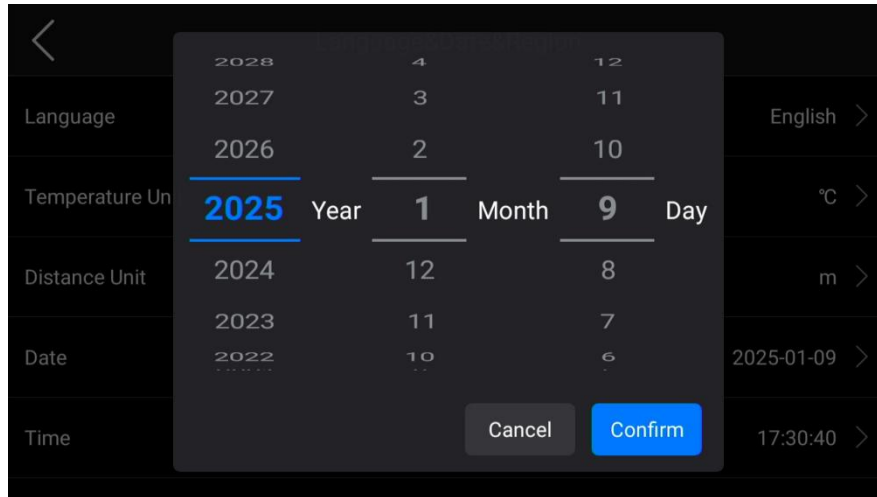

### Set Time:

1. On the main menu interface, press the OK button/touch the main menu to bring up the device menu.
2. **Device Menu → Settings → Device Set → Language&Time&Region → Time**
3. Set the time parameter.

### Set Time zone:

1. On the main menu interface, press the OK button/touch the main menu to bring up the device menu.
2. **Device Menu → Settings → Device Set → Language&Time&Region → Time zone.**
3. Set the time zone parameter

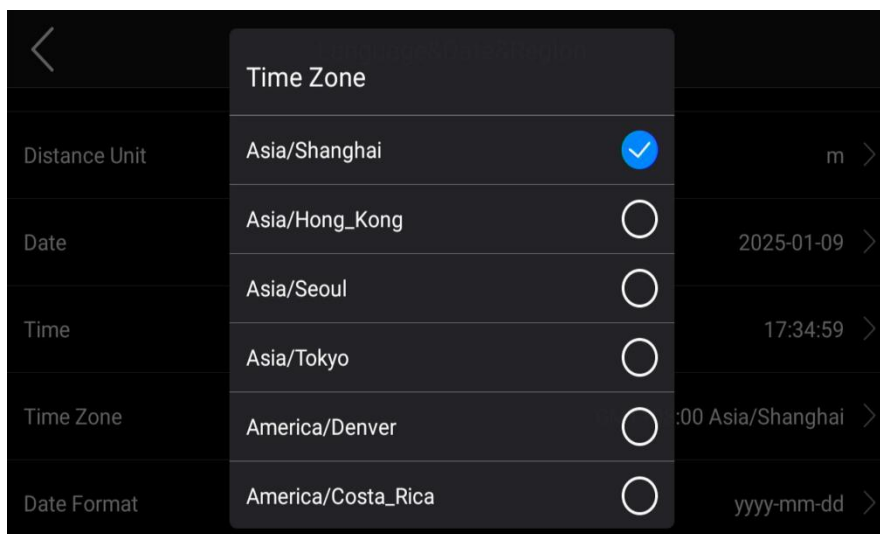

---

### Set Date Format:

1. On the main menu interface, press the OK button/touch the main menu to bring up the device menu.
2. **Device Menu → Settings → Device Set → Language&Time&Region → Date Format.**
3. Set the date format parameter.

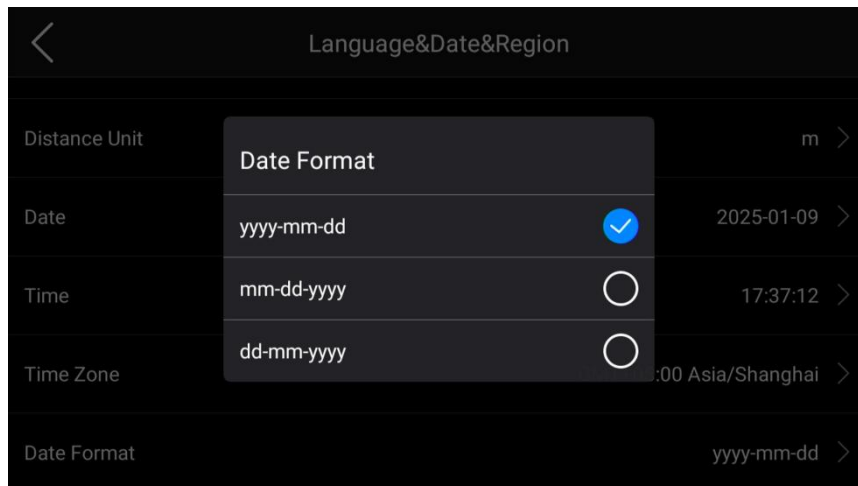

### Screen Brightness:

1. On the main menu interface, press the OK button/touch the main menu to bring up the device menu.
2. **Device Menu → Settings → Device Set → Screen Brightness.**
3. Slide the screen or press the left/right buttons to adjust the screen brightness.

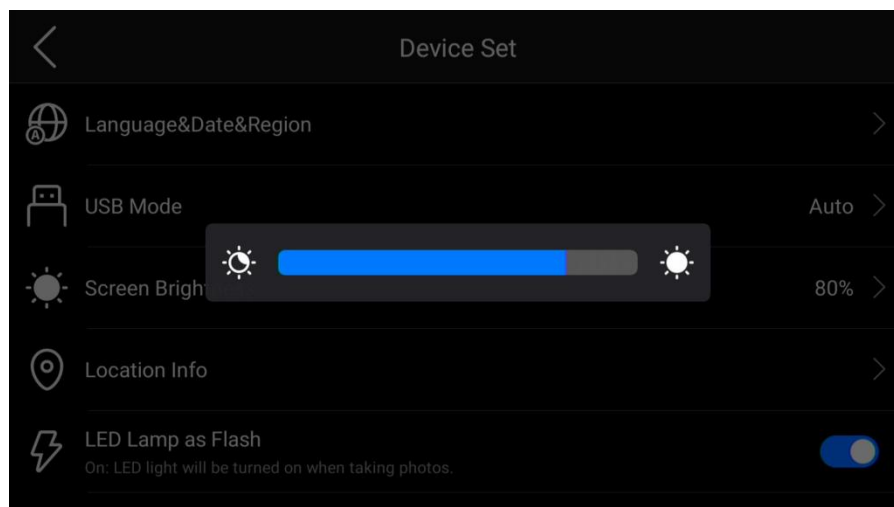

---

### Location Information:

Refer to 13.6 Compass

### LED as Flashlight:

Refer to 13.7 LED Lamp

### Auto Shutdown Time:

1. On the main menu interface, press the OK button/touch the main menu to bring up the device menu.
2. **Device Menu → Settings → Device Set → Automatic Shutdown Time.**
3. Set the auto shutdown time, which specifies how long the device will stay on after inactivity before automatically shutting down.

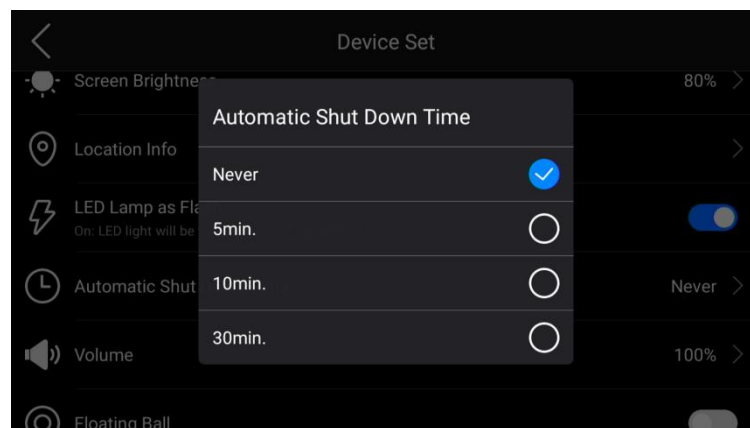

### Volume:

1. On the main menu interface, press the OK button/touch the main menu to bring up the device menu.
2. **Device Menu → Settings → Device Set → Volume.**

### Reset

Reset parameters to the factory default settings, or delete all saved files.

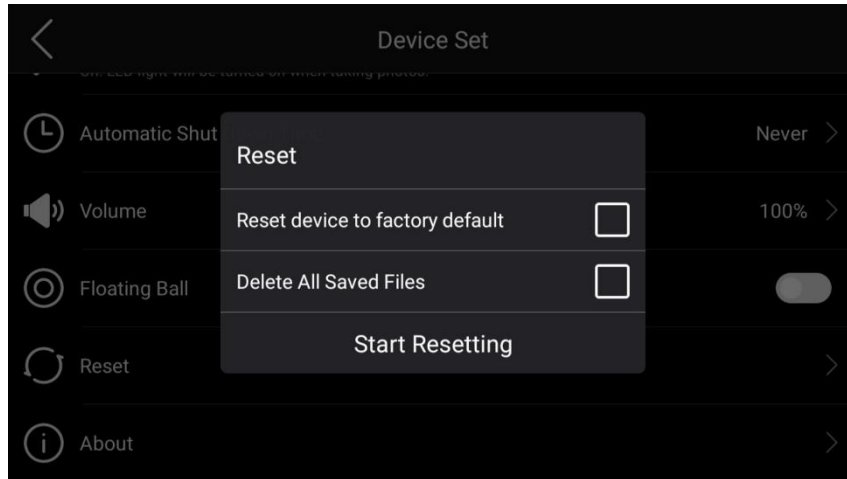

### Device Information

View model, serial number, application version, system version, lens, battery level, remaining SD storage capacity, status information (IMEI, IP address, MAC address, Bluetooth address), system update.

About	
Model	Fotric P7MiX
Serial Number	1001002892
App Version	6.8.0.6008924
System Version	1.2.0.89
AC Firmware	2.9.3.7
Microphone Channels	162
Battery Level	31%
Remaining SD Card Capacity	231.51GB
Status Information	>
System Update	>

## Appendix A. Emissivity table

(for reference only)

Material Name	Surface Condition	Temperature(°C)	Emissivity( $\epsilon$ )
Aluminum	Non-oxidized	100	0.20
	Oxidized	100	0.55
Brass	Polished brown	20	0.40
	Unpolished	38	0.22
	Oxidized	100	0.61
Copper	Severely oxidized	20	0.78
Iron	Oxidized	100	0.74
	Rusty	25	0.65
Cast iron	Oxidized	200	0.64
	Non-oxidized	100	0.21
Wrought iron	Roughened	25	0.94
	Polished	38	0.28
Nickel	Oxidized	200	0.37
Stainless steel	Oxidized	60	0.85
Steel	Oxidized at 800°C	200	0.79
Common brick	Surface	20	0.93
Concrete	Surface	20	0.92
Glass	Polished plate	20	0.94
Lacquer	White	100	0.92
	Natural color black	100	0.97
Carbon	Smoke black	25	0.95
	Candle soot	20	0.95
	Graphite rough surface	20	0.98
Paint	Average of 16 colors	100	0.94
Paper	White	20	0.93
Sand	Surface	20	0.90
Wood	Polished	20	0.90
Water	Distilled water	20	0.96
Skin	Human	32	0.98
Pottery	Fine	21	0.90
	Abrasive	21	0.93