



Advanced Handheld Acoustic Camera

User Manual

About this manual

This manual is used as a guide and the photos, graphics, icons and illustrations provided in the manual are for explanation and illustration purposes only and may differ from the specific product, please refer to the actual product. This manual may be updated by FOTRIC without notice due to product version upgrade or other needs. The trademarks and images used in this manual are for illustrative purposes only and are the copyright of the trademark owner.

Disclaimers

The products (hardware, software, etc.) provided in this manual may be defective, faulty or malfunctioning, and fotric disclaims all warranties of any kind, express or implied, including, but not limited to, warranties of merchantability, satisfactory quality, fitness for a particular purpose, non-infringement of third party rights, etc. fotric will not be liable for any special, incidental, consequential or indirect damages arising out of the use of this manual or our products. including, but not limited to, damages arising from loss of business profits, loss of data or documentation.

To the maximum extent permitted by law, our liability will not exceed the amount you paid for the product.

After the product is connected to the Internet, it may be exposed to risks including but not limited to network attacks, hacker attacks, virus infections, etc. The Company will not be responsible for any abnormal operation of the product, information leakage, etc. as a result, but will provide you with technical support in a timely manner.

When using this product, you are requested to strictly follow the applicable laws. You agree that this product is for civilian use only and shall not be used in violation of third party rights, medical/safety equipment or other applications where the failure of the product could result in life-threatening or personal injury, and for purposes such as mass destruction fog, biochemical weapons, nuclear explosions or any unsafe use of nuclear energy or dangerous or inhumane uses. Any loss or liability arising from such use will be borne by you.

In the event of a conflict between the above and applicable law, the provisions of the law shall prevail.

Preface



User Manual



Analysis Software



Symbols

 Warning	 Caution	 Note
potential death or serious injury inducing hazards.	potential danger of injury or property damage.	provides additional information to emphasize the main text.

Safety information

The purpose of this section is to ensure that the user uses the product properly to avoid danger or property damage.

Before using this product, please read this instruction manual carefully and keep it in a safe place for future reference.



Warning:

- Never disassemble or modify the acoustic camera battery. The battery is equipped with safety and protective devices which, if tampered with, may cause the battery to overheat and may also cause an explosion or burn. If the battery is leaking and the leak gets into your eyes, do not rub it, wash it with water and get immediate medical attention.
- If the unit is not working properly, contact your dealer or our company and do not disassemble or modify the unit in any way (unauthorized modifications or repairs cause problems at your own risk).



Caution:

- Protect the acoustic sensor array from stains, dust and liquids, otherwise it will affect the performance of the acoustic camera or even cause permanent damage.
- Avoid using the product in humid, dusty, extremely hot or cold environments, please refer to the product's parameter table for specific temperature and humidity requirements.
- It is strongly recommended to use the original power adapter, the specific requirements of the power adapter are shown in the product data sheet.
- To prevent the potential danger of data loss, always make a copy (backup) of your data on a computer.

- When storing the acoustic camera, it is strongly recommended to use the original box and to keep it in a cool, dry, ventilated environment free from strong electromagnetic fields.
- When shipping the acoustic camera, it is strongly recommended that it be shipped protected in its factory packaging.

Table of Content

1. PRODUCT COMPONENTS	6
1. FRONT VIEW	6
2. REAR VIEW	7
3. SIDE VIEW	8
2. PREPARATION.....	10
1. INSERTING AND REMOVING THE BATTERY.....	10
1.1 Inserting the battery	10
1.2 Removing the battery.....	10
2. CHARGING.....	11
2.1 Charging through the charging dock.....	11
2.2 Charging directly with DC 12V.....	12
3. POWER ON AND OFF	13
3.1 Power On	13
3.2 Power Off	13
4. SLEEP AND WAKE.....	14
5. CONNECTING TO EXTERNAL DEVICES AND STORAGE MEDIA.....	14
6. INSTALLING THE WRIST STRAP	14
3. ACOUSTIC IMAGING DISPLAY	14
1. SOUND SOURCE MODE	15
1.1 Single Sound Source.....	15
1.2 Multi Sound Source.....	15
1.3 Hologram.....	16
2. PALETTES.....	16
3. BLACK AND WHITE BACKGROUND	17
4. TRANSIENT MODE (T-FFTD®).....	17
5. DIGITAL ZOOM.....	18
6. IMAGE OVERLAY INFORMATION.....	19
7. SOUND PRESSURE TRACKING	19
4. ACOUSTIC MEASUREMENT ANALYSIS	19
1. FREQUENCY RANGE SELECTION	19
2. MEASUREMENT TOOLS	20
2.1 Add Spot.....	20
2.2 Add Circle	21
3. DETECTION MODE.....	21
4. PARTIAL DISCHARGE MODE.....	22
5. LEAKAGE EVALUATION MODE	23
6. ACOUSTIC IMAGE FOCUS	23
7. ON-DEVICE ANALYSIS	24
8. ANALYSIS SOFTWARE.....	25

5. ACOUSTIC IMAGING BASIC PARAMETERS	25
1. DISTANCE	25
2. AC DEVICE SET	26
6. CAPTURE FUNCTIONS.....	26
1. SINGLE FRAME CAPTURE	27
1.1 File Naming Format	27
2. TIME-LAPSE CAPTURE	28
3. VIDEO RECORDING	30
3.1 Holographic video recording	30
3.2 MP4 Video Recording.....	31
3.3 Video Format.....	31
4. FREEZE INTERFACE	32
5. QR CODE SCAN	33
6. VOICE ANNOTATION.....	34
7. TEXT ANNOTATION	35
8. TAG TABLE.....	36
9. FAVORITES	38
10. SKETCH	39
11. GALLERY.....	39
12. ON-DEVICE REPORT	42
7. CONNECTION	42
1. WIFI CONNECTION.....	42
2. BLUETOOTH	43
3. USB INTERFACE	44
4. HDMI INTERFACE	46
5. FTP.....	46
8. REMOTE CONTROL.....	47
1. MOBILE DEVICE CONTROL	47
2. WEBPAGE CONTROL	47
9. AUXILIARY FUNCTIONS	47
1. FLOATING BALL.....	47
2. ULTRA-TO-AUDIBLE CONVERSION	48
3. LASER	ERROR! BOOKMARK NOT DEFINED.
4. REGION FEATURE MEASUREMENT	ERROR! BOOKMARK NOT DEFINED.
5. GPS	49
6. COMPASS	50
7. LED LAMP	50
8. LANGUAGE.....	51
9. SOFTWARE AND FIRMWARE UPGRADES	52
10. DEVICE SET	55

1. Product Components

1. Front View

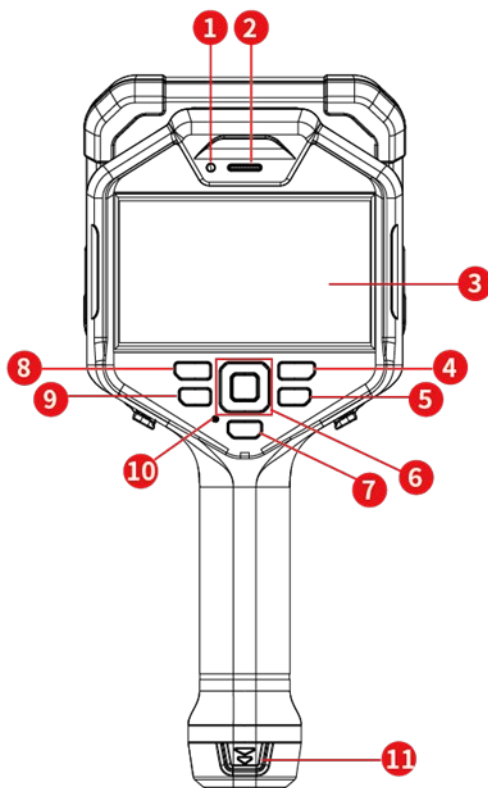

2. Rear View

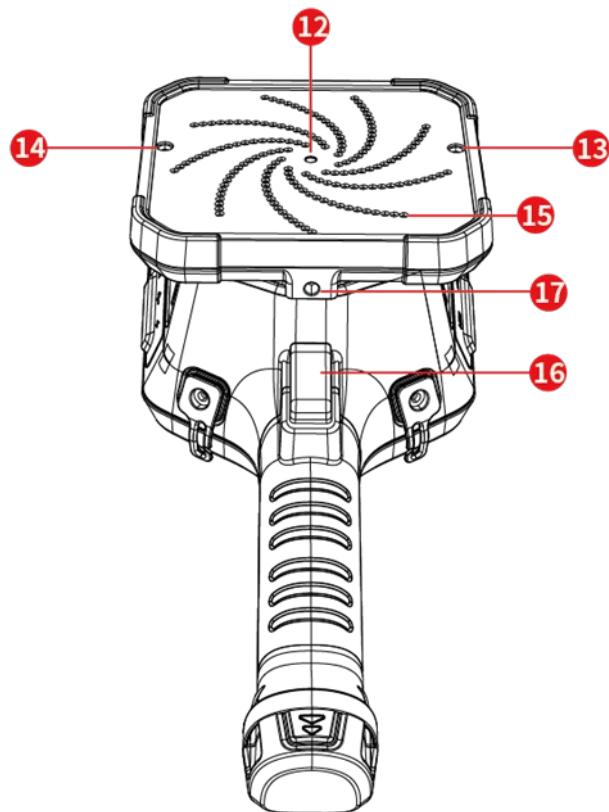

3. Side View

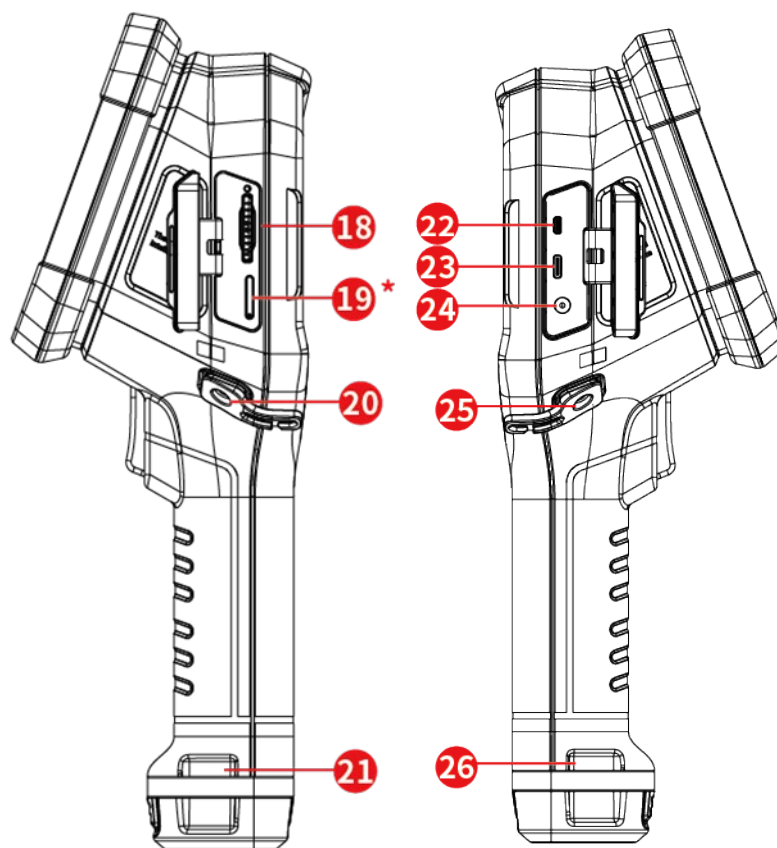

Note
The appearance of different models of advanced handheld acoustic imagers may vary. Please refer to the actual product.

Parts and interfaces

	Name	Function
1	Indicator LED	<ul style="list-style-type: none"> ● Green, blinking: charging ● Green, glowing: fully charged, screen off
2	Speaker	Play voice, alarm
3	Touch Screen	<ul style="list-style-type: none"> ● Display ● Touch screen operation
4	Gallery Button	Enter gallery ⁸
5	Back Button	Exit menu or back to the previous menu

6	Navigation Buttons	Menu mode
		<ul style="list-style-type: none"> ● Press ▲, ▼, ◀, ▶ to select parameters ● Press confirmation key to confirm
		Non-menu mode
		Press confirmation key to summon the menu
7	AI Programmable Button	<ul style="list-style-type: none"> ● Short press: activate custom functions ● Long press: select custom functions
8	Power Button	<ul style="list-style-type: none"> ● Short press: power on/off device ● Long press: sleep/wake screen
9	LED Button	Turn on/off LED light
10	Microphone	Input voice information
11	Battery	Lithium battery, for power supply
12	Digital Camera	Digital visible-light camera
13 & 14	LED Flash Light	<ul style="list-style-type: none"> ● Flash light : serve as a flash light when taking photos ● For illumination in dark environment
15	Acoustic Module	Microphone array
16	Freeze and Capture Button	Freeze and capture images/videos
17	Tripod Connection Interface	For mounting on a tripod
18	SD Storage Card Interface	For inserting the SD card
19*	Nano SIM Port (optional)	For inserting Nano SIM card
20 &	Wrist Strap Bracket	For fixing the wrist strap(left)

21		
22	Micro HDMI Interface	For connecting to a HDMI screen
23	USB Type-C Interface	For connecting to a USB Type-C cable
24	Power Supply Interface	For connecting to DC power adaptor
25 & 26	Wrist Strap Bracket	For fixing the wrist strap(right)

2. Preparation

1. Inserting and Removing the Battery

1.1 Inserting the battery

Push the battery into the battery socket. When the battery is fully inserted, it will make a distinct 'click'.

1.2 Removing the battery

Turn off the device, squeeze the snatch of the battery and take it out.

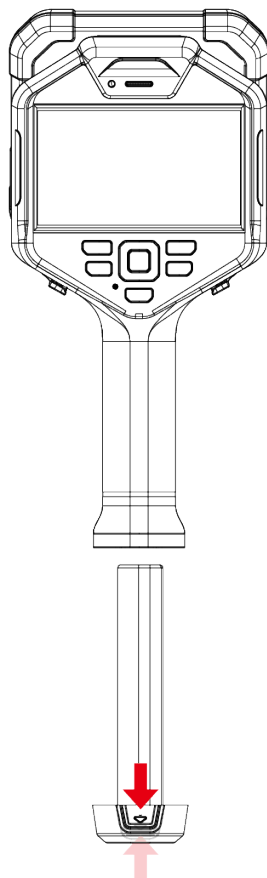

2. Charging

When using the acoustic imager for the first time or when the power is low, please charge the acoustic imager.

2.1 Charging through the charging dock

For quick charging take out the battery and mount it on the charging dock. The voltage of the charging dock is 12VDC, please use the USB-C cable and the adaptor that came with the device.

Operation Procedures

1. Mount the battery(s) to the charging dock.
2. Connect the charging dock to the power source. If the dock is functioning normally, the middle LED indicators will glow green.
3. The LED indicators on the side indicate the charging status of the battery:
 - Red: charging
 - Green: charged
4. When fully charged, take out the battery and disconnect the dock from the power source.

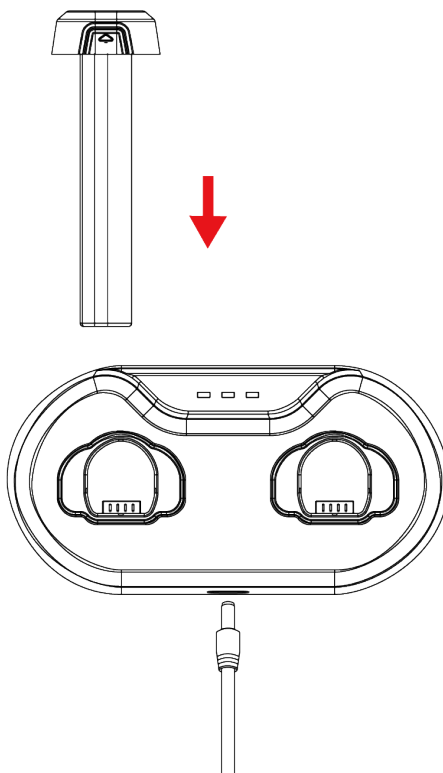

2.2 Charging directly with DC 12V

For expedient charging, directly charge the acoustic imager through a DC 12V power adapter.

Operation Procedures

1. Insert the battery
2. Lift the cover for power supply interface
3. Connect to a power source and start charging

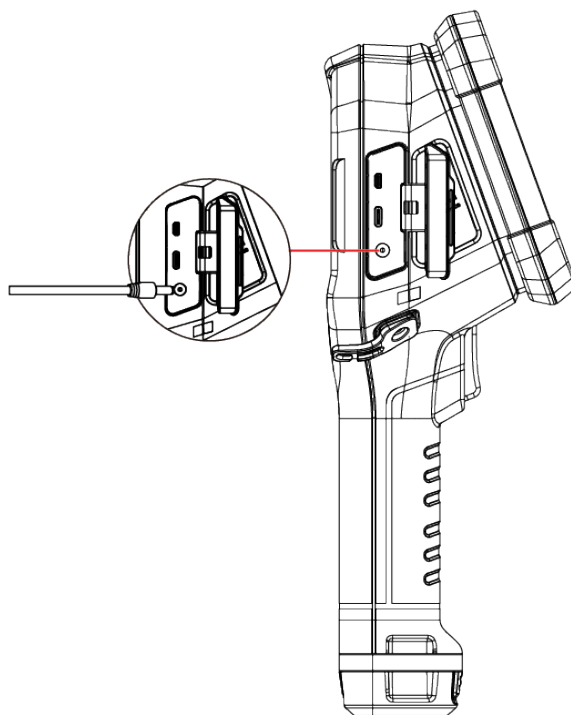

3. Power On and Off

3.1 Power On

When sufficient battery power is available, press and hold the Power button to turn on. Once powered on, enters the real-time observation interface.



Note:

If battery power is low, charge or replace the battery promptly to avoid affecting usage.

3.2 Power Off

Turn off manually or set an automatic shutdown time.

Manual Shutdown

Press and hold the Power button to turn off.

Automatic Shutdown

Set the automatic shutdown time. If no touch screen operation, no button press, and no USB connection, automatically shuts down after the set time is reached.

4. Sleep and Wake

Put into sleep mode manually to save power and extend battery life.

Press the Power button briefly to put into sleep mode or wake up.

5. Connecting to External Devices and Storage Media

External Devices

Use a compatible HDMI cable to connect one end to the device's Micro HDMI interface and the other end to a display. The image will be projected onto the connected screen.

Storage Media

The device is equipped with a storage card to store captured inspection data, reports, and other files.



Note

The included storage card may vary; please refer to the actual device.

6. Installing the Wrist Strap

Inserting the strap through the Wrist Strap Bracket and make adjustments

(Refer to the item 20 & 21, 25 & 26 of **Parts and interfaces** table)

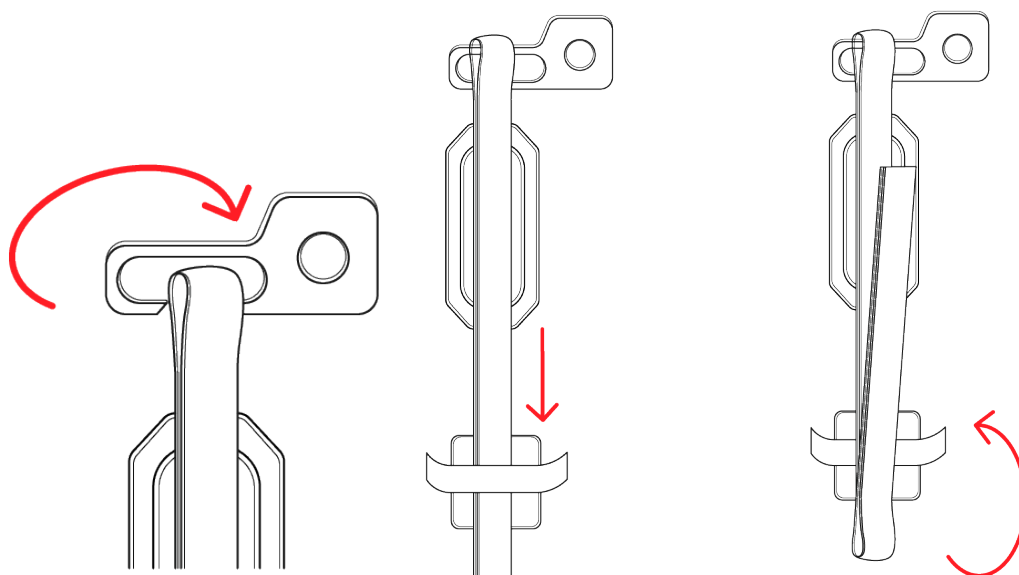

3. Acoustic Imaging Display

1. Sound Source Mode

The sound imaging device can detect sound sources in various modes, which can be switched according to your preferences. The specific operation steps are as follows:

1. Switch to the "AC" interface by tapping the "IR" button in the lower-left corner of the screen.
2. In the main menu interface, press the OK button or tap the main menu to bring up the device menu.
3. **Device Menu → Sound Source Mode**

1.1 Single Sound Source

Overlay the sound image of multiple high sound pressure areas on the visible light image. The specific operation steps are as follows:

1. **Main menu interface:** Press the OK button or tap the main menu to bring up the device menu.
2. **Device menu → Sound source mode → Multiple sound sources**

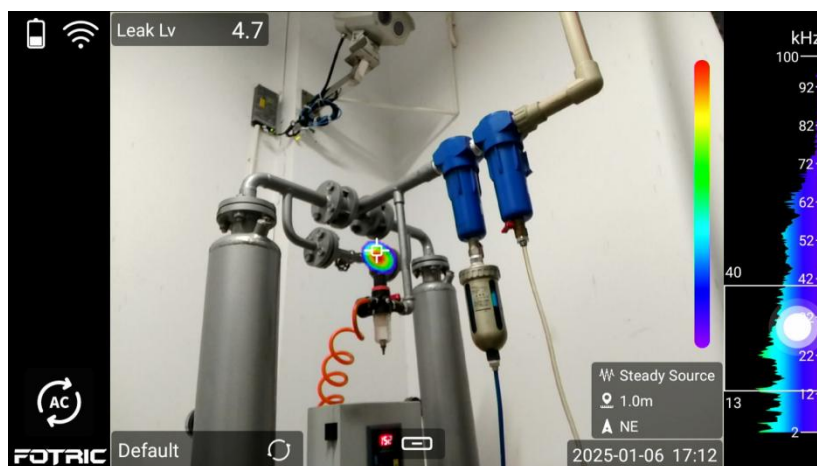

1.2 Multi Sound Source

Overlay the sound image of multiple high sound pressure areas on the visible light image. The specific operation steps are as follows:

3. **Main menu interface:** Press the OK button or tap the main menu to bring up the device menu.
4. **Device menu → Sound source mode → Multiple sound sources**

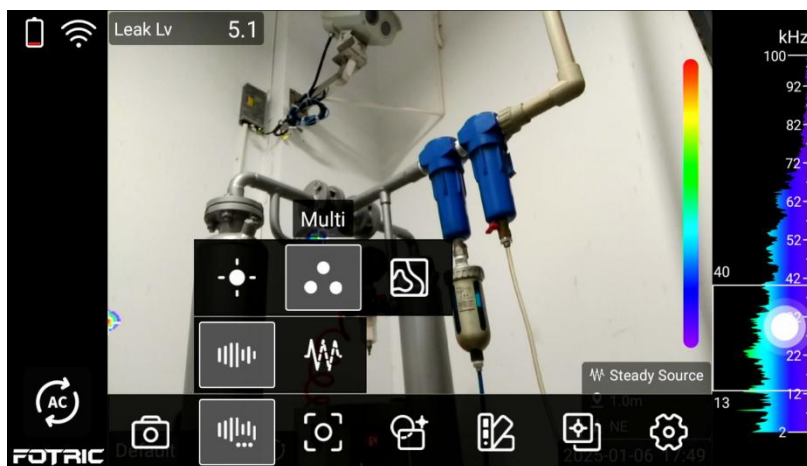

1.3 Hologram

Adjust the sound pressure threshold and overlay the sound image of the areas above the threshold on the visible light image. The specific operation steps are as follows:

1. In the main menu interface, press the OK button or tap the main menu to bring up the device menu.
2. **Device menu** → **Sound source mode** → **Hologram**

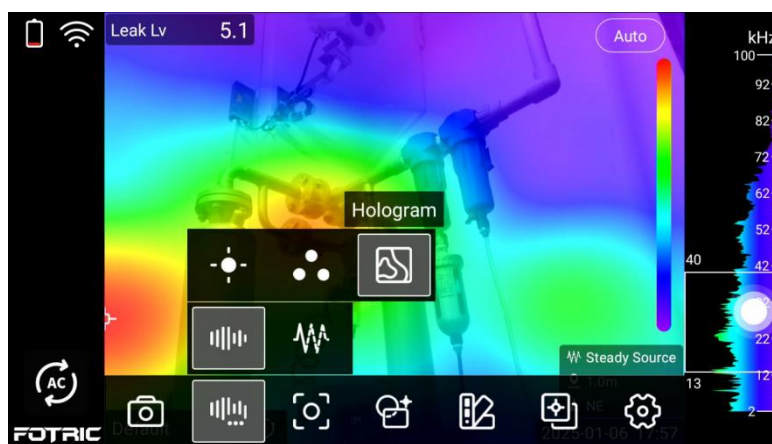

2. Palettes

The color palette can be changed to display different high sound pressure areas, and it supports adjusting the transparency with three available color palettes. The specific operation steps are as follows:

1. In the main menu interface, press the OK button or tap the main menu to bring up the device menu.
2. **Device menu** → **Color palette** (adjustable: red-blue, iron red, gray-white).
3. **Device Menu** → **Palette** → **More** → Tap the icon in the upper right corner to adjust the transparency of the palette.

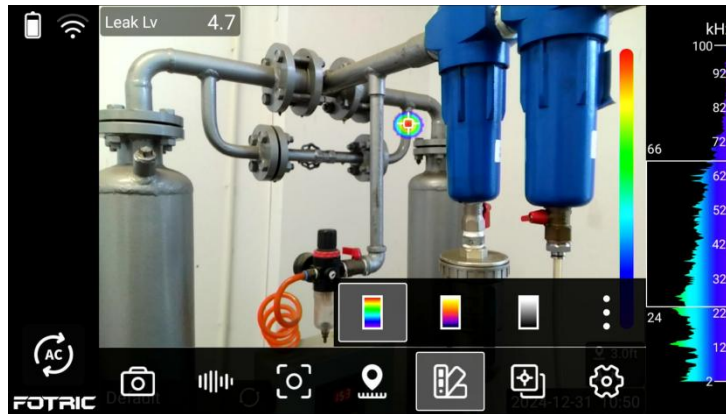

3. Black and White Background

During acoustic imaging detection, the color visible light image can be displayed as a black-and-white grayscale visible light image. The specific steps are as follows:

1. In the main menu interface, press the OK button or tap the main menu to open the device menu.
2. Navigate to **Device Menu** → **Palette** → **More** → **Tap the second icon in the upper right corner to switch the image to a black-and-white background**

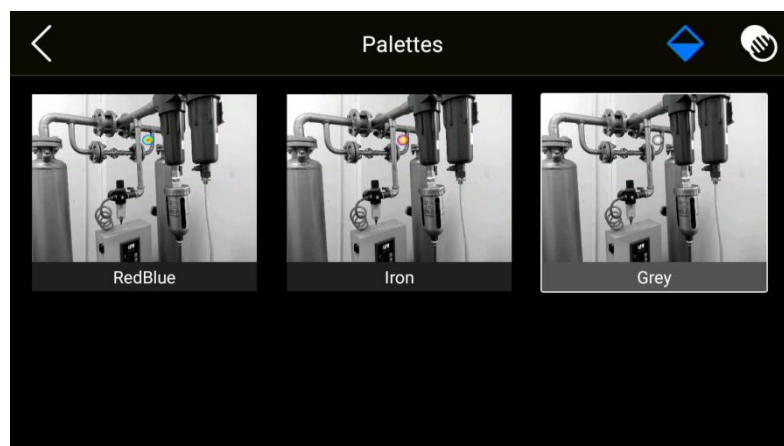

4. Transient Mode (T-FFTD®)

Capture transient sound signals and allow them to remain on the real-time acoustic image for a longer duration, assisting in identifying issues such as intermittent leaks, partial discharges, vibrations, and abnormal noises. The specific steps are as follows:

1. In the main menu interface, press the OK button or tap the main menu to access the device menu.

2. Navigate to **Device Menu** → **Settings** → **AC Device Set** → **Measurement Enhancement** → **Enable T-FFTD®**.
3. Return to the main menu interface → **Acoustic Parameters** → **T-FFTD®** (the user can choose between transient sound sources or steady-state sound sources).

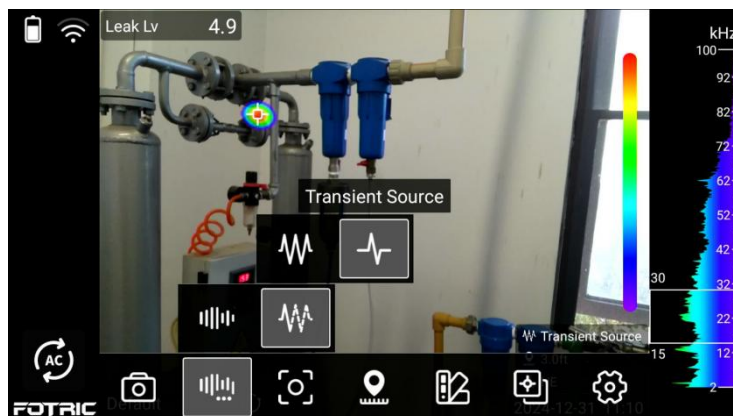

5. Digital Zoom

The device's digital zoom function allows control over image zoom display. The specific steps are as follows:

1. **Zoom In:** Use two fingers to touch the screen and spread them apart.
2. **Zoom Out:** Use two fingers to touch the screen and pinch them together.
3. When the zoom level exceeds 1x, a zoom slider wheel will appear:
 1. Adjust the zoom level by sliding the wheel on the touch screen or using the left/right directional keys.
 2. Press the OK button or the Back button to hide the zoom slider wheel.
 3. Alternatively, tap the zoom level value again to reactivate the zoom adjustment slider.

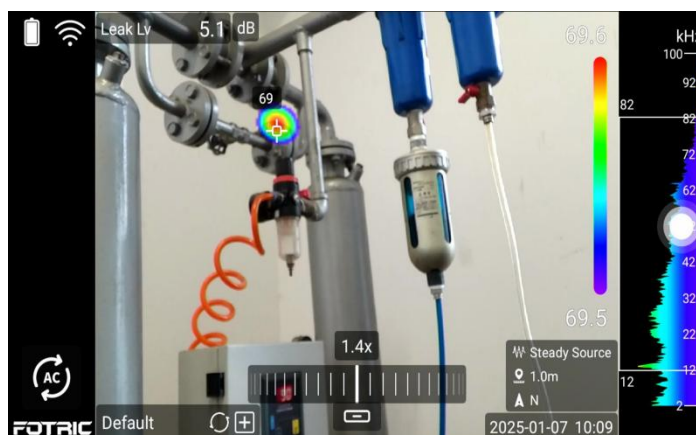

6. Image Overlay Information

The device can overlay parameters, sound pressure values, and other information onto image files. The specific steps are as follows:

Leakage Mode:

1. Displays leakage evaluation parameters and results Including measurement parameters, compass information, as well as date and time information.

Partial Discharge Mode:

1. Displays partial discharge diagnostic parameters, PRPD patterns, and results Including measurement parameters, compass information, as well as date and time information.

7. Sound Pressure Tracking

To automatically track the maximum sound pressure using special markers and overlay the acoustic image of the strongest sound pressure area on the visible light image,



4. Acoustic Measurement Analysis

1. Frequency Range Selection

Supporting Pre-configured Frequency Ranges for Different Scenarios and Manual Adjustment of Frequency Bands.

1. Main menu interface: Press the OK button or tap the main menu to bring up the device menu

2. Device Menu → Settings → AC Device Set → Enable Frequency Configuration

3. Return to the real-time screen and tap the bottom left corner to customize the frequency band range

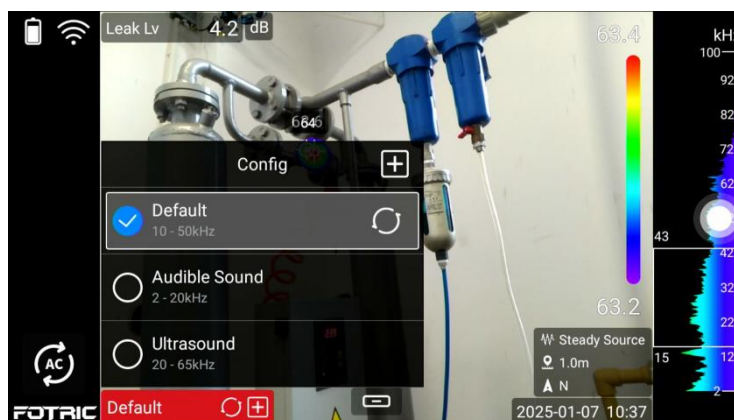

2. Measurement Tools

The device allows for measurement of specific locations, boundaries, or areas by setting points, circles.



2.1 Add Spot

The specific steps are as follows:

1. In the main menu interface, press the OK button or tap the main menu to bring up the device menu
2. **Device menu → Settings → AC Device Set → Measurement Enhancement → Enable Measurement Tool**
3. **Return to the main interface → Device menu → Measurement Tools → Add Spot.**
4. Tap the selected measurement point, drag it or use the directional keys to move and adjust the spot's position.

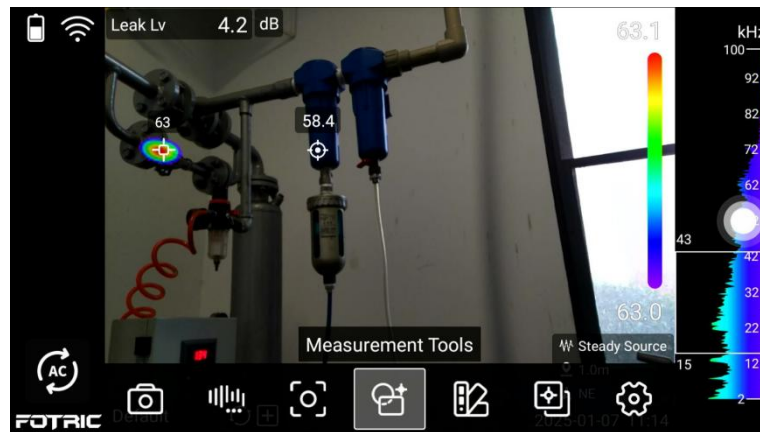

2.2 Add Circle

The specific steps are as follows:

1. In the main menu interface, press the OK button or tap the main menu to bring up the device menu.
2. **Device menu → Settings → AC Device Set → Measurement Enhancement → Enable Measurement Tool**
3. **Return to the main interface → Device menu → Measurement Tools → Add Circle.**
4. Tap the selected measurement circle, drag it or use the directional keys to move and adjust the position of the measurement circle.

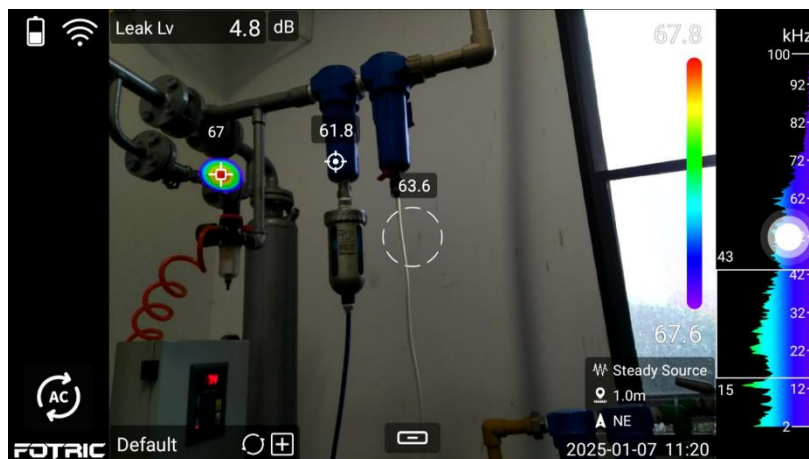

3. Detection Mode

The **Detection Modes** are divided into two types: **Partial Discharge Mode** and **Leak Detection Mode (Leakage Evaluation Mode)**



The detection modes on the device depend on the specific model. Please refer to the

actual device for the available detection modes.

4. Partial Discharge Mode

The device is equipped with Partial **Discharge (PD) Detection** functionality, along with various intelligent features that significantly enhance the user's detection efficiency, ensuring quick and accurate fault diagnosis and maintenance.

Partial Discharge Diagnosis: Supports diagnostic types, discharge probability, AC frequency, and PRPD graph.

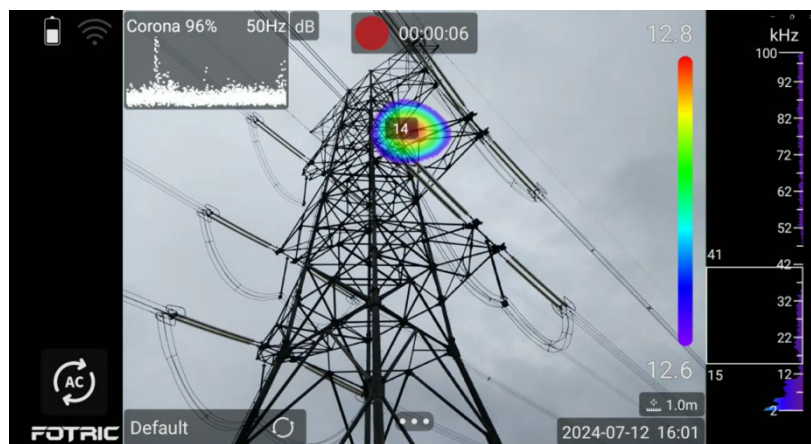

4.1. AC Frequency

The AC frequency is only applicable in **Partial Discharge Mode** and is adaptable to different AC frequencies (50/60Hz). The specific steps are as follows:

1. In the main menu interface, press the OK button or tap the main menu to bring up the device menu.
2. **Device menu** → **Settings** → **AC Device Set** → **AC Frequency** (Change to the appropriate frequency based on the usage scenario).

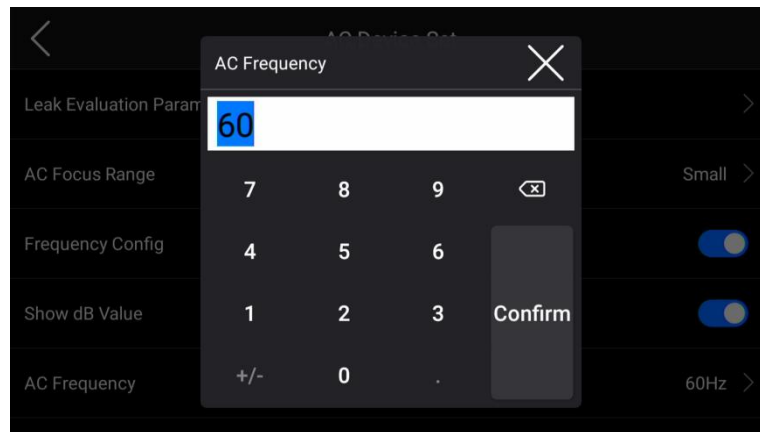

5. Leakage Evaluation Mode

The device is equipped with **Gas leak detection** functionality and comes with various intelligent features that significantly enhance detection efficiency, ensuring fast and accurate fault diagnosis and maintenance.

Leakage Assessment: Supports leakage level, leakage rate, and cost

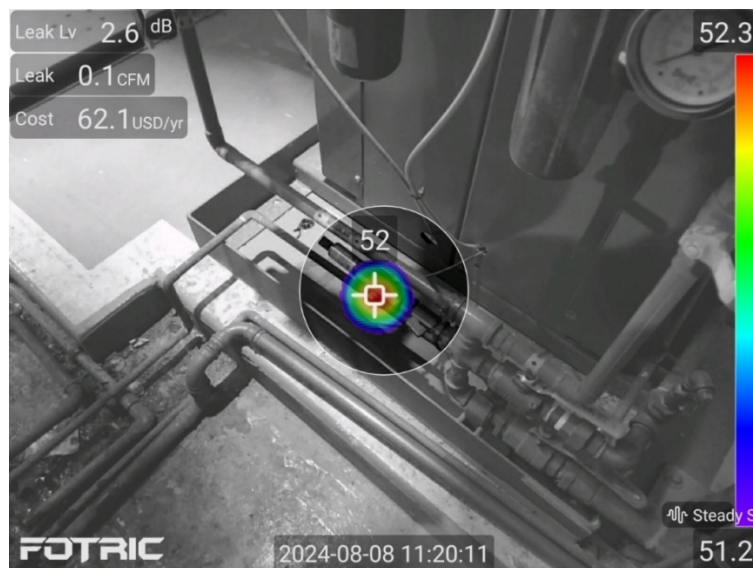

6. Acoustic Image Focus

To shield surrounding areas and focus on a specific region's acoustic image, minimizing noise interference and emphasizing key positions, please conduct the following steps:

1. In the main interface, press the OK button or tap the main menu to bring up the device menu
2. **Device menu → Acoustic Image Focus**

3. **Device menu → Settings → AC Device Set → Acoustic Image Focus Range** (The user can adjust the size of the focus ring)

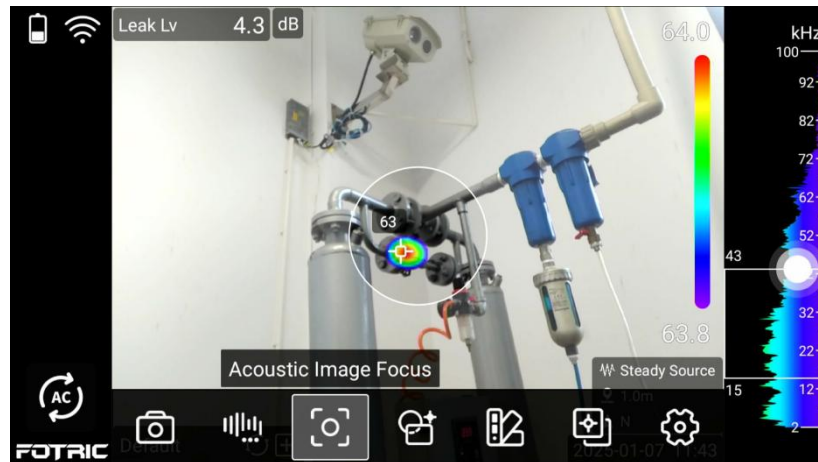

7. On-device Analysis

The device supports quick analysis of acoustic images and holographic acoustic videos to promptly identify, analyze, and resolve issues. The specific operation steps are as follows:

1. Press the gallery button to enter the gallery homepage.
2. Use the touch or directional buttons to select the acoustic image or radiometric video to be analyzed.
3. Press the OK button to enter the gallery preview interface.
4. Press the OK button again to bring up the gallery preview menu.
5. Click the "Analyze" button to enter the gallery analysis interface.
6. Analyze the acoustic image data and save the results.
7. Press the back button to exit.

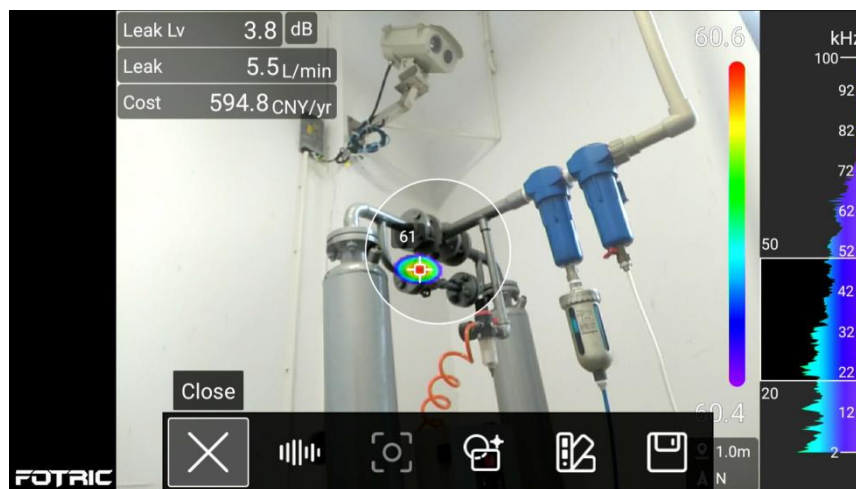
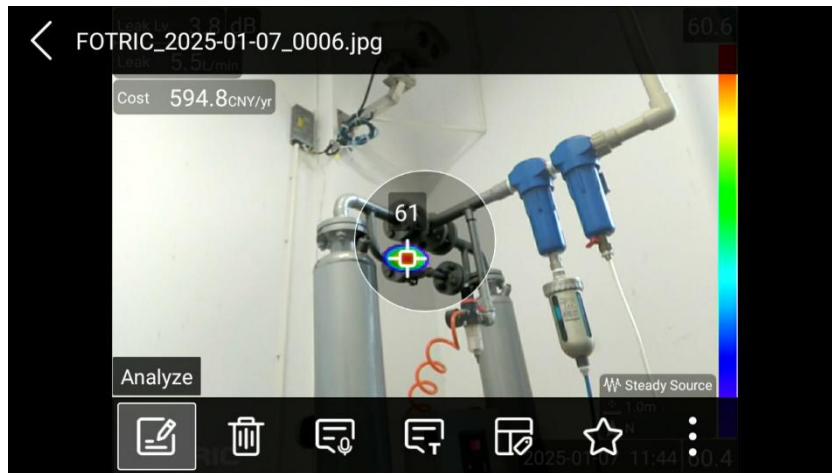

8. Analysis Software

The device supports professional analysis software, which allows for real-time control and display of acoustic images, analysis of acoustic image data, and quick batch generation of professional reports. For detailed operations, please refer to the user manual of the analysis software.

5. Acoustic Imaging Basic Parameters

1. Distance

The distance to the sound source is calculated in real-time through the acoustic sensor's received sound signals. The specific operation steps are as follows:

1. In the main menu interface, press the OK button or tap the main menu to bring up the device menu.

2. Device menu → Target distance (adjust based on the test scenario).
3. Find and press the device's laser key for a long press; the device will automatically measure the distance.

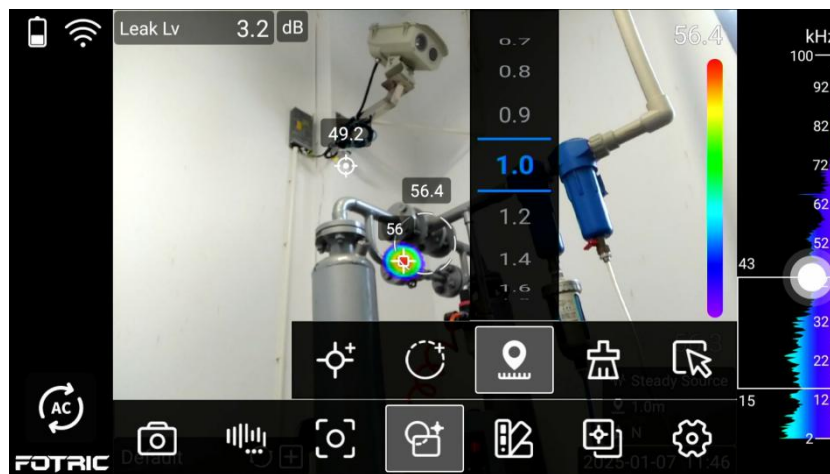

2. AC Device Set

AC Device Set includes: Leak Evaluation Parameters(see Appendix for more information), AC Focus Range, Frequency Config, Show dB values, AC frequency, SPL Normalization, and Measurement Enhancement. The specific operation steps are as follows:

1. In the main menu interface, press the OK button or tap the main menu to bring up the device menu
2. **Device Menu → Settings → AC Device Set**
3. Enter the AC Device Set page where the user can configure each parameter as needed

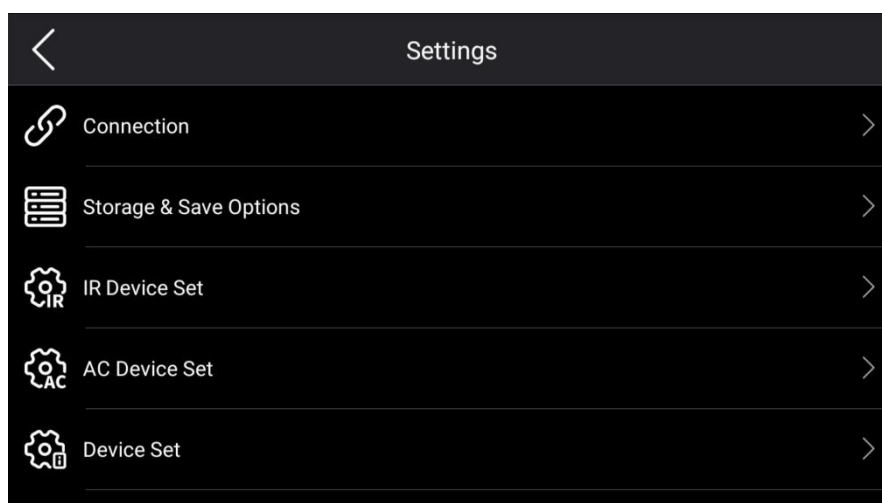

6.Capture Functions

1. Single Frame Capture

Capture an image in the main menu interface and save it to the device's storage card.

Operation steps:

1. In the main menu interface, press the OK button or tap the main menu to bring up the device menu
2. **Device menu → Capture Mode → Single Frame Capture**
3. Press the shutter button to freeze the image.
4. Press the shutter button again to capture a single image

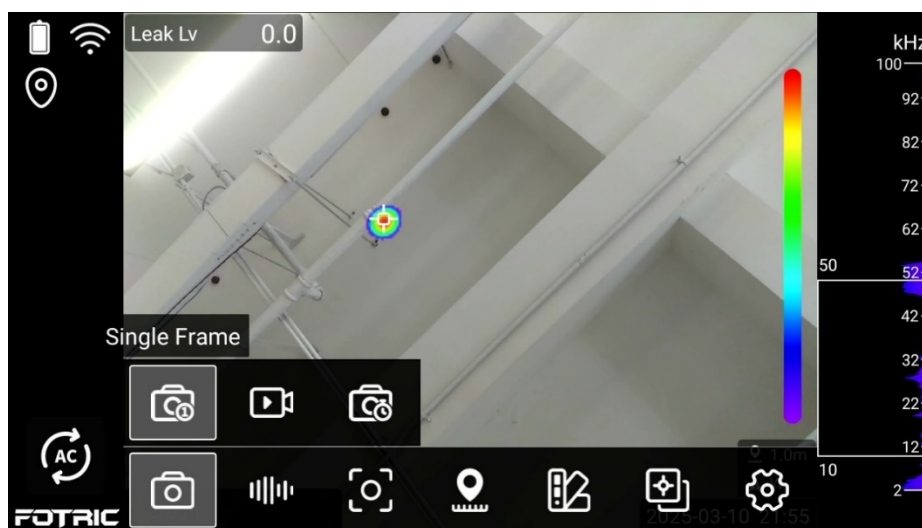

NOTE

- To enable freeze frame before saving, follow steps 1, 2, 3, and 4
- If freeze frame before saving is not enabled, follow steps 1, 2, and 4
- To enable/disable freeze frame before saving, go to "**Settings → Storage and Save Options.->Freeze Image Before Saving**"

1.1 File Naming Format

Named by Date & No.

To use a date-based serial number for naming files:

1. In the main menu interface, press the OK button or tap the main menu to bring up the device menu.
2. **Device menu → Settings → Storage and Save Options → Choose "Named by Date & No."** under File naming format.

3. Complete a single-frame capture (File name: Named by Date & No). **Go to the gallery → Image preview → File properties, and check the file name: Named by Date & No.**

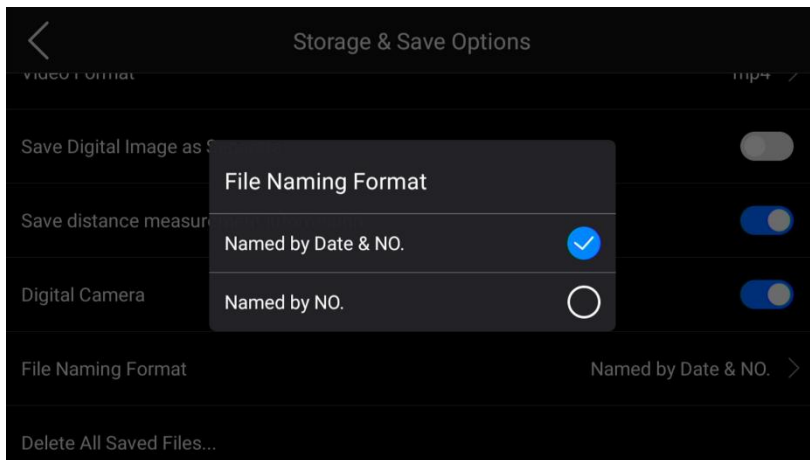

Named by NO.

1. In the main menu interface, press the OK button or tap the main menu to bring up the device menu.
2. **Device menu → Settings → Storage and Save Options → Choose "Named by No."** under File naming format.
3. Complete a single-frame capture (File name: Named by Date & No). **Go to the gallery → Image preview → File properties, and check the file name: Named by No.**

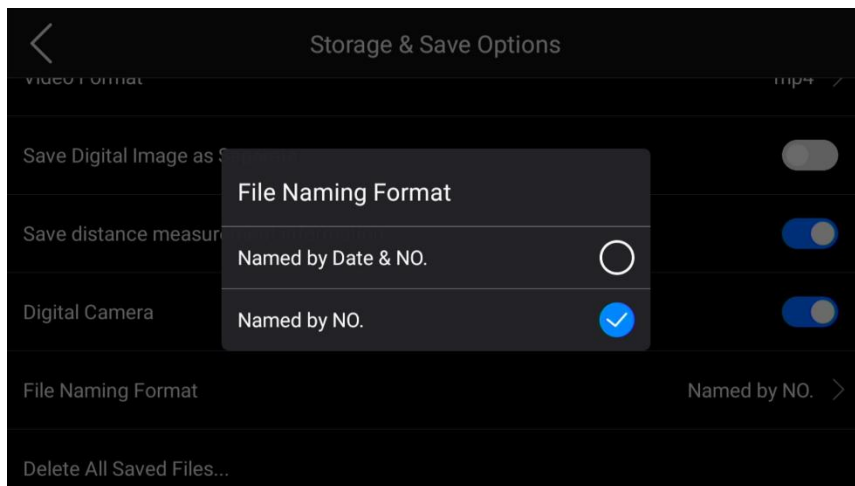

2. Time-lapse Capture

Set a time interval ranging from 2 seconds to 1 hour to automatically save images in infrared, T-DEF® Blend, or picture-in-picture mode, and store them on the device's memory card.

Time-lapse Capture Operation Steps :

1. In the main menu interface, press the OK button or tap the main menu to bring up the device menu.
2. **Device menu → Capture Mode → Time-lapse Capture.**
3. In the Time-lapse Capture menu, press OK or tap the Time-lapse Capture menu to set the time-lapse capture parameters.
4. Press the capture button to start Time-lapse capture.
5. Press the capture button again to stop the Timed-lapse capture.

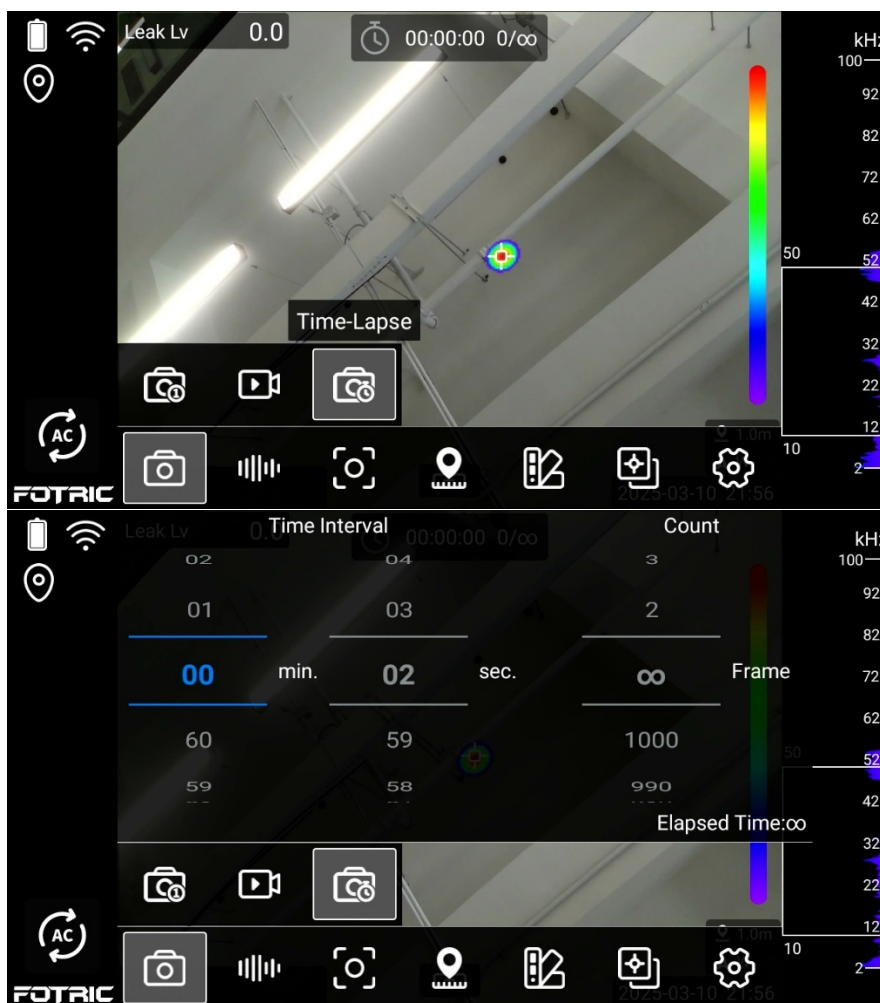

 **NOTE**

1. The Time-lapse capture mode on the device depends on the specific model, please refer to the actual device for details.

During the Time-lapse capture process, only focusing operations and stopping the Time-Lapse capture are allowed. No other operations are supported.

3. Video Recording

The device can record video clips and save them to the storage card, supporting ACS, and MP4 file formats.

- **ACS** (Holographic acoustic video): This format is used for holographic acoustic videos and is supported only in acoustic image mode.
- **MP4** (Standard video): This format is used for regular videos and is supported in all modes.

3.1 Holographic video recording

Supports analyzable holographic video recording up to 7 minutes long and saved on the device's memory card.

Steps:

1. In the main menu interface, press the OK key/tap the main menu to bring up the device menu, and select the original video in the video format;
2. **Device menu**→ **Capture Mode**→ **Recording: Raw data**;
3. Recording menu, press OK key/touch the recording menu to set the recording frame rate of holographic pan video;
4. Press the photo button to start recording the holographic audio and image video;
5. Press the photo button again, and the holographic sound and image video recording is completed.



NOTE

1. The full radiation video recording mode on the device depends on the specific model, so please refer to the actual device.
2. The video format selection can be set through "Settings → Storage and Save Options."

3.2 MP4 Video Recording

Supports MP4 video recording in various image modes, and saves the video to the device's storage card.



Operation Steps:

1. In the live interface, press the OK button or tap the main menu to bring up the device menu, then select MP4 as the video format.
2. Go to **Device Menu** → **Capture Mode** → **Recording: MP4**.
3. Press the shutter button to start recording the MP4 video.
4. Press the shutter button again to finish the MP4 video recording

NOTE

- The MP4 video recording mode on the device depends on the specific model, so please refer to the actual device for details.
- The video format selection can be set through "Settings → Storage and Save Options."

3.3 Video Format

Raw data

1. In the live interface, press the OK button or tap the main menu to bring up the device menu.
2. **In the device menu** → **Settings** → **Storage and Save Options**, select "Raw Data" for the video format.

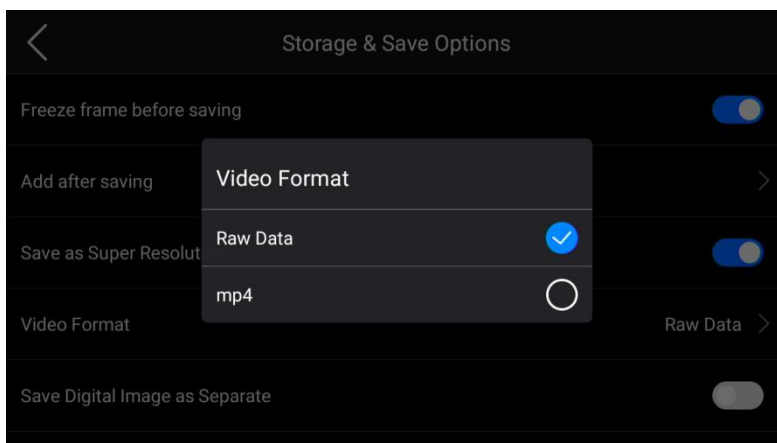

MP4

1. In the live interface, press the OK button or tap the main menu to bring up the device menu.
2. In the device menu → Settings → Storage and Save Options, select "MP4" for the video format.

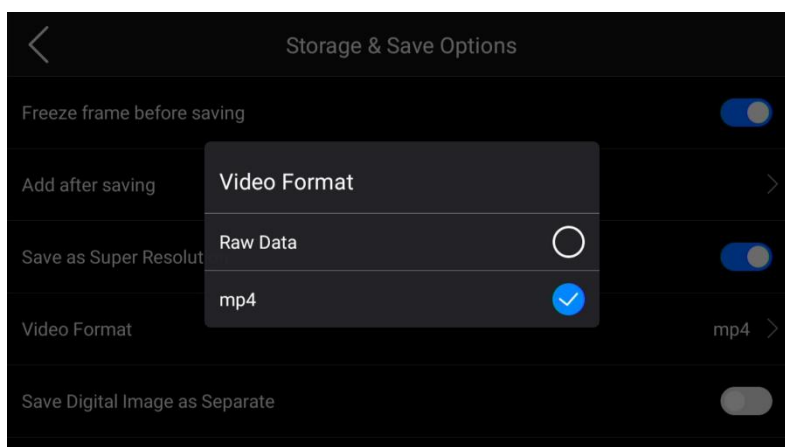

4. Freeze Interface

In infrared image, visible light temperature measurement (T-DEF®), and picture-in-picture modes, when taking a single frame, the freeze frame function can be enabled for preview.

Operation Steps: In single-frame capture mode, press the snapshot button to enter the freeze frame for the image.

Voice Annotation:

Please refer to **Capture Functions** → 6 Voice Annotation.

Text Annotation:

Please refer to **Capture Functions** → 7 Text Annotation.

Tag Table

Please refer to **Capture Functions** → 8 Tag Table

Favorites:

Please refer to **Capture Functions** → 9 Favorites

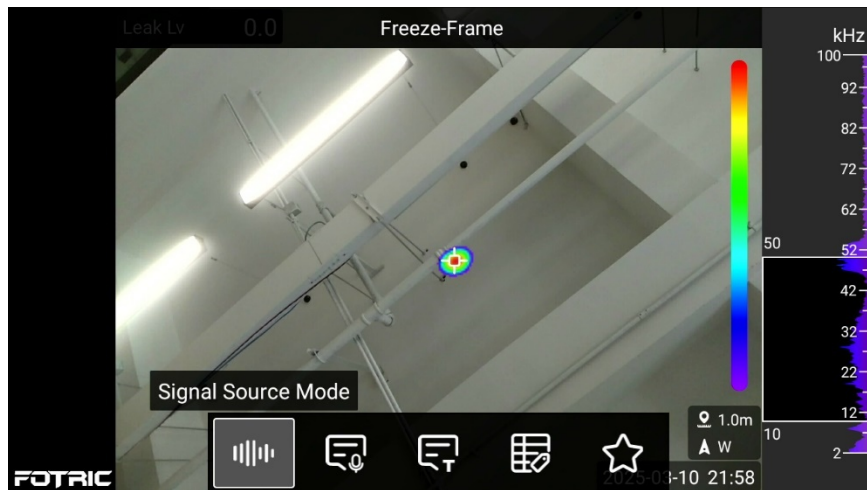

The freeze function on the device depends on the specific model. Please refer to the actual device for details.

5. QR Code Scan

Scan the QR code to use it as a text note and tag.

Steps for Operation:

1. Freeze the screen or preview the gallery, press the OK button or tap the main menu to bring up the device menu.
2. In the device menu, go to Text Annotation → Scan QR Code
3. Tap , and align it with the QR code to be scanned, displaying the QR code content;
4. Tap the "Save" button to successfully save the QR code content.

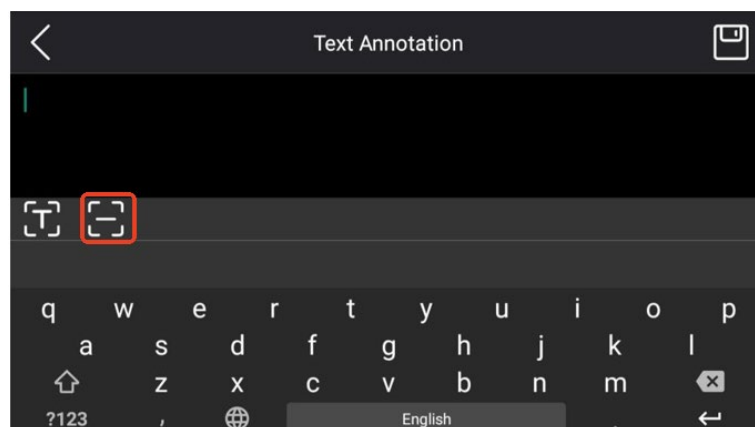

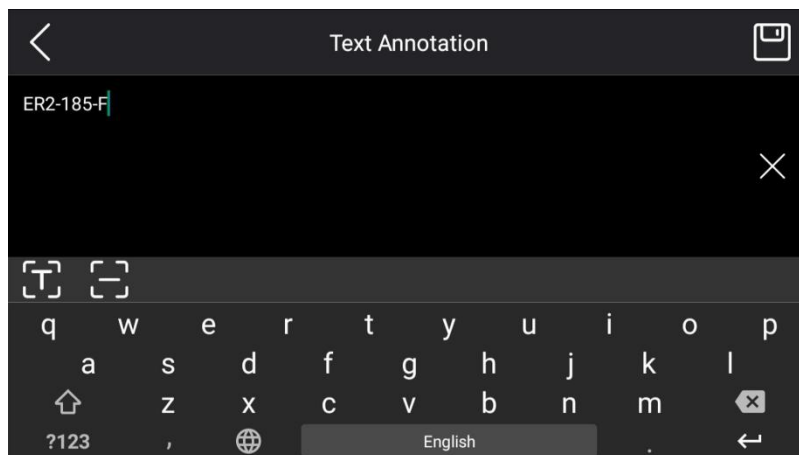



 **NOTE**

The QR code function on the device may vary depending on the specific model. Please refer to the actual device.

6. Voice Annotation

Record Voice Annotation with a maximum duration of 120 seconds and save it to the acoustic image and full radiation video.

Steps for operation:

1. Freeze the screen or preview the gallery, press the OK button or tap the main menu to bring up the device menu.
2. In the device menu, go to Voice Annotation.
3. Tap  to start recording the voice annotation.
4. Tap  to stop recording the voice annotation.
5. Tap  to play the recorded voice annotation.
6. Tap the button to delete the recorded voice annotation.

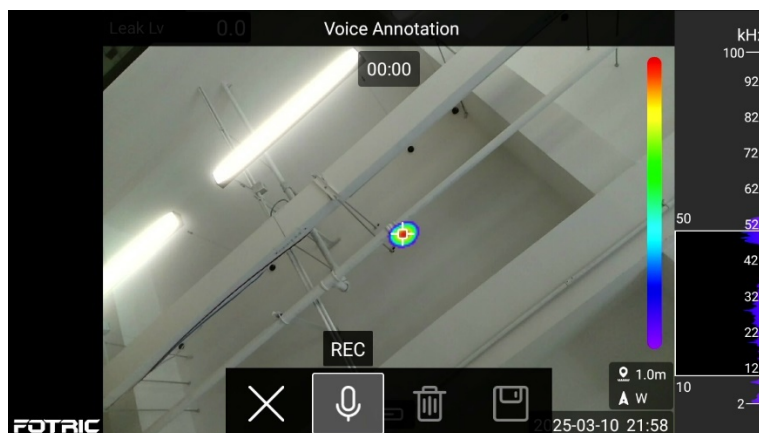

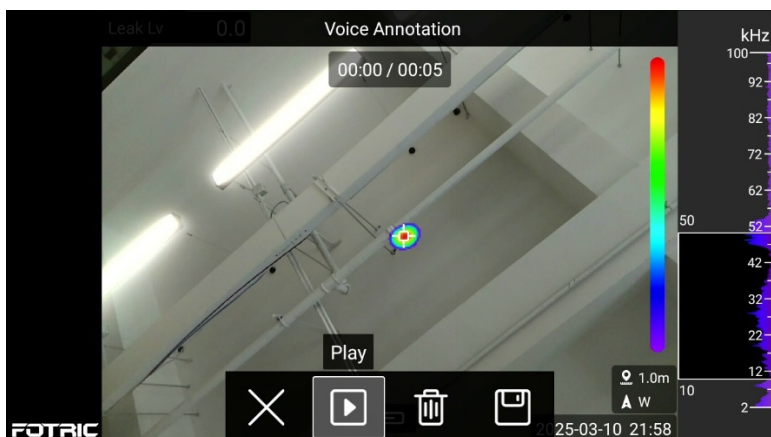
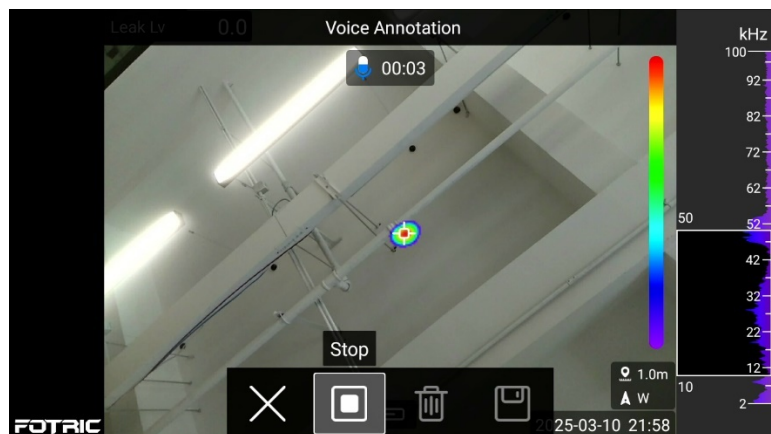

 **NOTE**

The voice annotation function on the device may vary depending on the specific model. Please refer to the actual device.

7. Text Annotation

Steps for operation:

1. Freeze the screen or preview the gallery, press the **OK button** or tap the **main menu** to bring up the device menu.
2. In the device menu, go to **Text Annotation**.
3. After successfully inputting through manual keyboard entry, OCR text recognition, QR code scanning, or tap the **Save** button. The content will be saved successfully, and a text note icon will appear in the top left corner of the image.

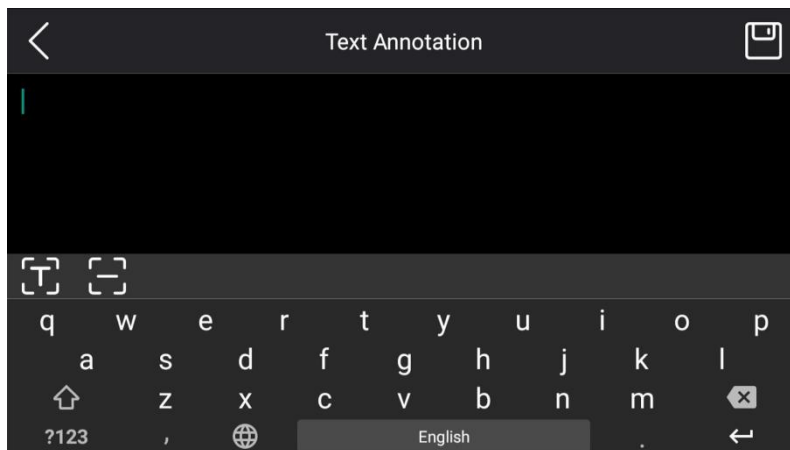

 **NOTE**

The voice note function on the device may vary depending on the specific model. Please refer to the actual device.

8. Tag Table

Here is the English translation of the provided instructions:

Each row in the label table can be entered through a dropdown list or soft keyboard input, saved to a file, and then filtered by label values in the gallery. The specific steps are as follows:

1. Freeze the screen/gallery preview, press the OK button or touch the main menu to bring up the device menu.
2. **Device menu** → **Tag Table**

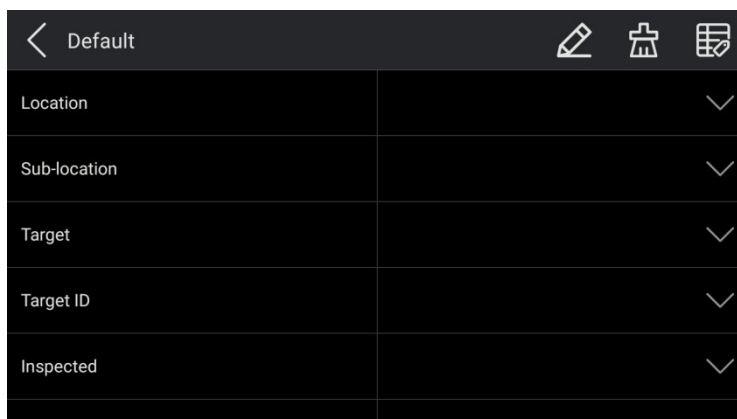

3. As shown in the image, the left side represents the field name, and the right side represents the field value. The field value can be selected from a dropdown list or entered as text. For example, in the image, select the dropdown option "Company A," then change it to "Company AA." Afterward, click the button to add "Company AA" to the dropdown options.

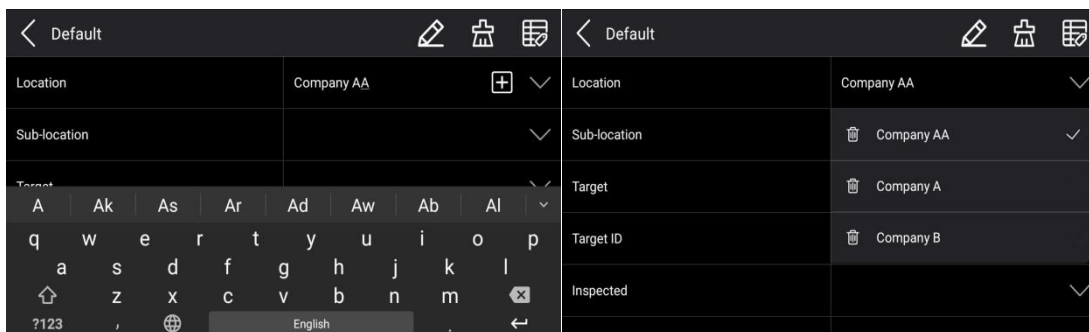

4. Press the back button and select "Save table" to complete the addition of the Tag table.



Function: Clicking this button will enable editing field names, allowing the user to add, modify, and delete them. After editing, click the button again to save the changes.

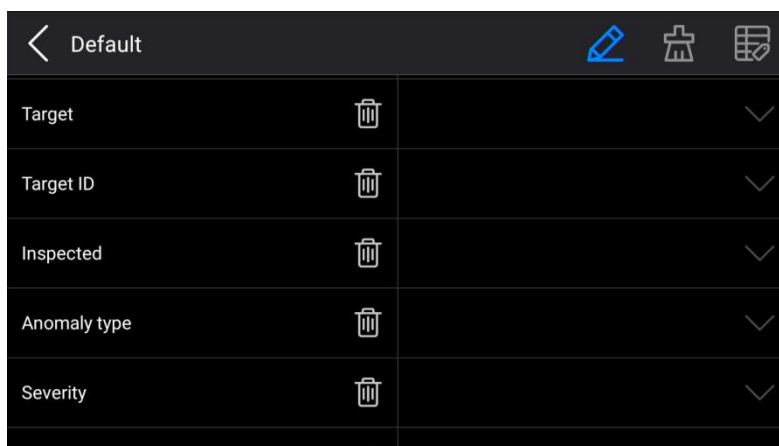

Function: Clicking this button will clear all field values.



Function: Clicking this button allows you to switch between different table templates. To do this, create a new folder called "TagTable" on the device's storage card, and import the custom label templates from the PC software. Then, the user can select different table templates on the device.

- **Default** is the default label table that comes with the device.
- **Tag Template 1** is a user-customized label template.

Default	
Location	Default ✓
Sub-location	Tag Table 1
Target	✓
Target ID	✓
Inspected	✓

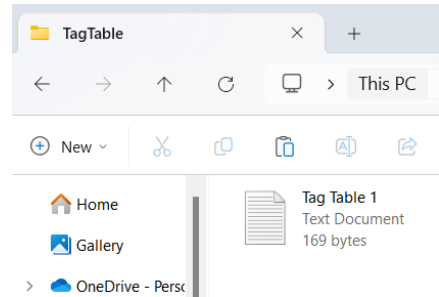

Sorting Function: When you press and hold a row, the following status will appear, allowing you to drag it to a suitable position above or below for sorting.

Default		Default	
Location	CompanyAA ✓	Location	CompanyAA ✓
Sub-location	✓	Sub-location	✓
Target	✓	Target ID	✓
Target ID	Target ✓	Target	✓
Inspected	✓	Inspected	✓

 **NOTE**

The label function on the device depends on the specific model; please refer to the actual device for details.

9. Favorites

Operation Steps:

1. Freeze the screen/gallery preview, press the OK button or touch the main menu to bring up the device menu.
2. **Device menu** → **Favorites**
3. Press the OK button or touch the favorite icon, and the favorite icon will appear in the top-left corner of the image.

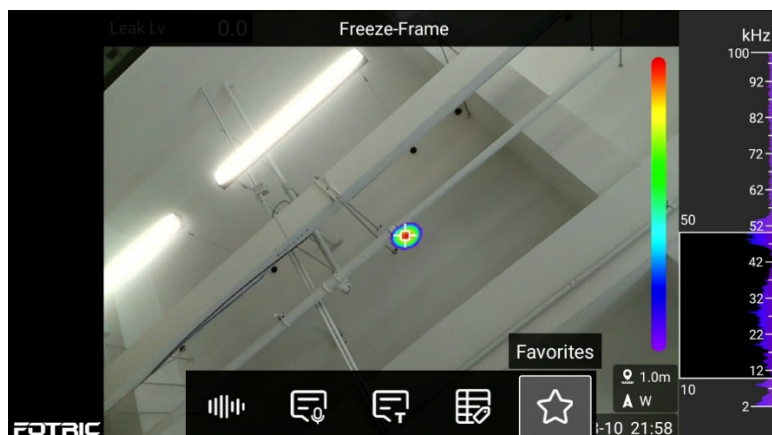

NOTE

The collection function on the device depends on the specific model; please refer to the actual device for details.

10. Sketch

Make sketched by dragging your finger on the display screen and save it to the acoustic image.

Operation steps:

1. Enter the sketch interface through the Add after saving/Gallery preview interface...;
2. Select the graffiti pen of the corresponding color as needed to draw;
3. Select the eraser to erase the excess graffiti part, click the Save button, and the sketch is successfully saved to the acoustic image.

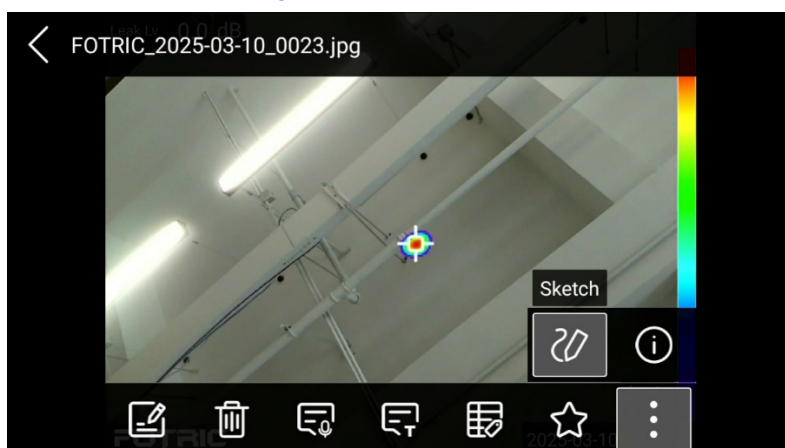

11. Gallery

The files are saved on the SD storage card, and the user can view all the saved files through the gallery.

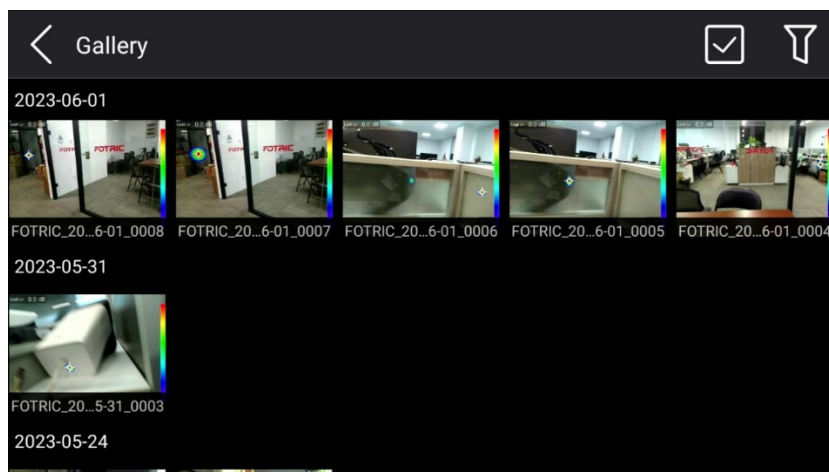

Operation Steps:

1. Press the Gallery button on the device to enter the gallery interface.
2. Press the Back button on the device to return to the live view interface.



Generate Report: 9.12 On-device Report

Delete

- Click the selection icon /button at the top of the gallery, or press the selection icon  at the top and then press the OK button.
- Select one or more files, then click the delete icon/button at the top of the gallery, or press the delete icon at the top and then press the OK button.
- Click the confirm button to successfully delete the selected files

Filtering

- Click the filter icon/button at the top of the gallery, or press the filter icon at the top and then press the OK button.
- Select "Favorites" to successfully filter out the files marked as favorites.
- Select "IR" to successfully filter out the files taken with the acoustic imager.
- Select "AC" to successfully filter out the files taken with the acoustic imager.
- Select a specific tag to successfully filter out the files with that tag.

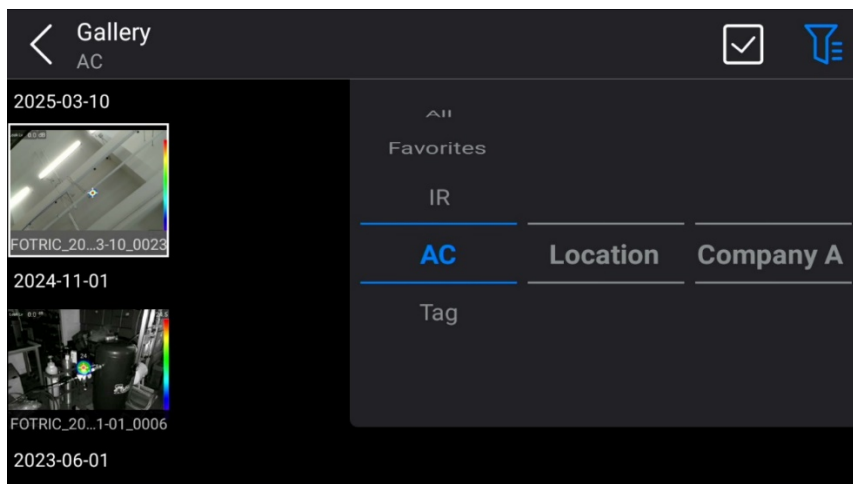

Gallery Preview

The acoustic image has been selected. Touch the acoustic image or press the OK button to enter the gallery preview interface

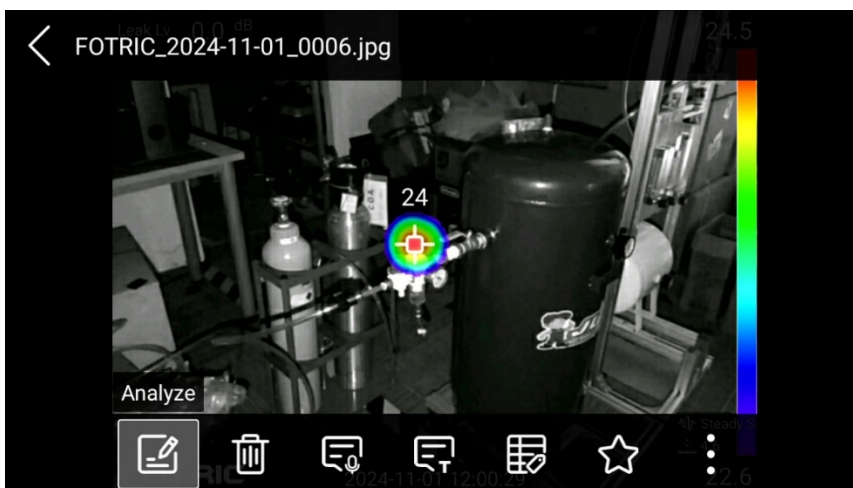

Delete Function:

Click the delete button, and the image or video will be successfully deleted

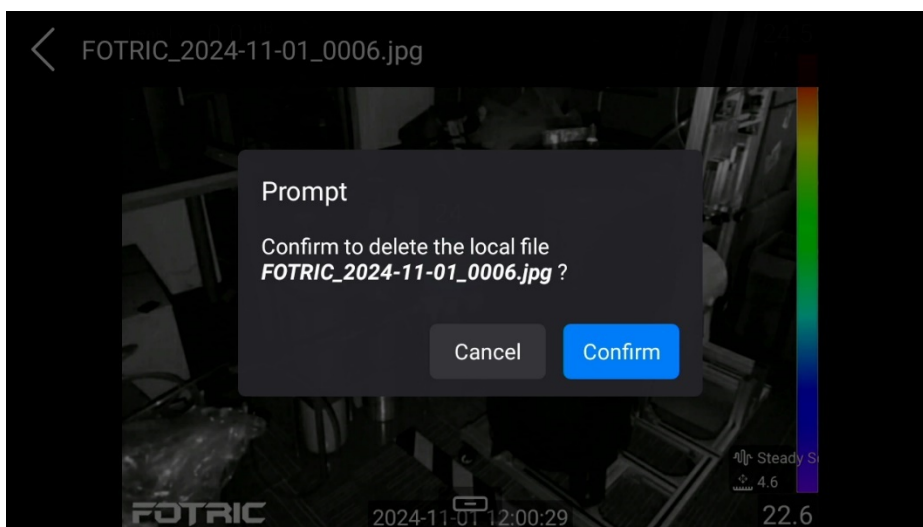

12. On-device Report

Support the generation of Word or PDF reports from single or multiple acoustic images.

Operating Steps:

1. Click the selection icon above the gallery  / Press the key to directly reach the selection icon

 above, then press the OK key;

2. Select one or more acoustic images, click the 'Generate Report' icon above the gallery / Press the key to directly reach the 'Generate Report' icon above, then press the OK key;

3. Select the report format: docx, tap / press the OK key to successfully generate a .docx report for the selected acoustic image.;

4. Select the report format: pdf, tap / press the OK key to successfully generate a .pdf report for the selected acoustic image.

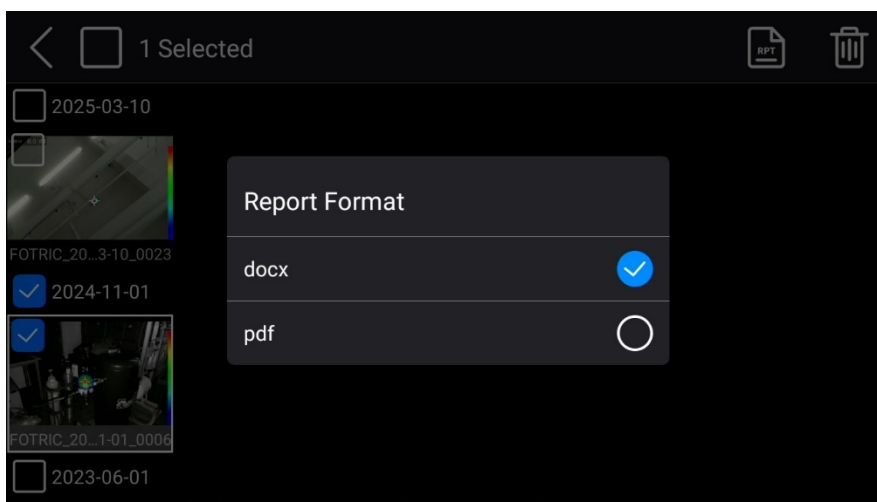

NOTE

The built-in report function on the device may vary depending on the specific model. Please refer to the actual device.

7. Connection

1. WiFi Connection

Use Wi-Fi to connect the device to a wireless local area network (WLAN).

Steps:

1. On the main menu interface, press the OK button or tap the main menu to bring up the device menu.

2. Go to **Device Menu** → **Settings** → **Connection** → **WLAN**.
3. Enable the wireless network, which will display a list of available networks. Select a network.
4. Choose one of the available networks. Networks with password protection will be indicated by a padlock icon. To access these networks, enter the password and click the "Join" button. The wireless network will be successfully connected.

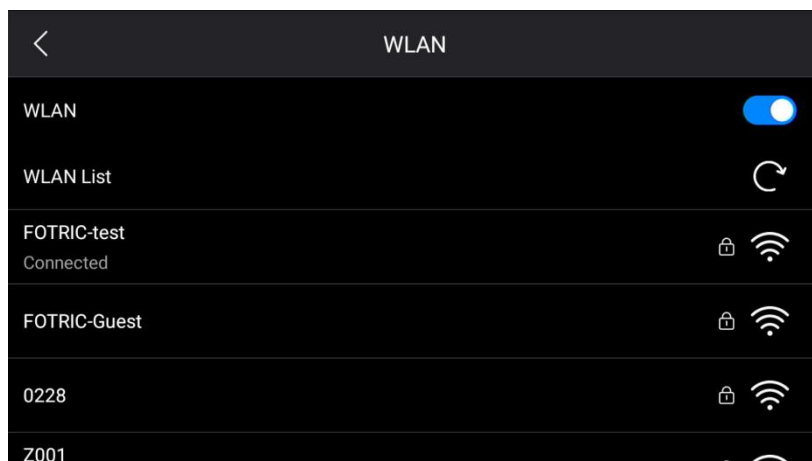

The Wi-Fi connection function on the device depends on the specific model. Please refer to the actual device for details.

2. Bluetooth

Bluetooth Connection

After enabling Bluetooth, the user can search for nearby Bluetooth headphones for pairing. Once paired successfully, the user can listen to the recorded voice in the acoustic image and radiometric video through the Bluetooth headphones.

Steps:

1. On the main menu interface, press the OK button or tap the main menu to bring up the device menu.
2. Go to **Device Menu** → **Settings** → **Connection** → **Bluetooth**.
3. Enable Bluetooth connection, which will display a list of available Bluetooth headphones.
4. Select an available Bluetooth headphone to connect. Once the Bluetooth connection is successful, the status will change to "Connected."

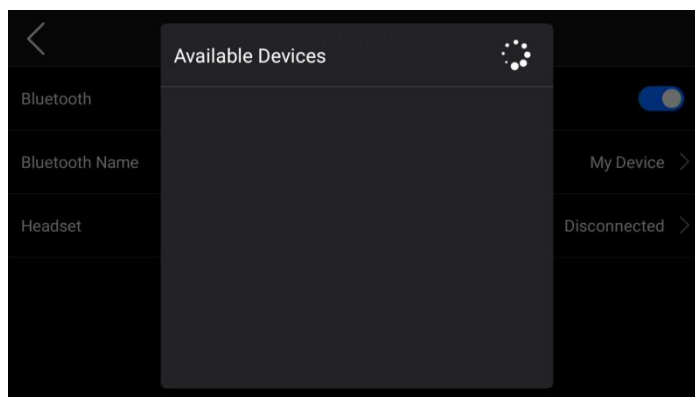

NOTE

- Bluetooth connection function depends on the specific model. Refer to the actual device for details.
- After adding a Bluetooth headphone, it can be used to add voice annotations.
- Once a Bluetooth headphone is added, the built-in microphone and speaker are automatically disabled.

3. USB Interface

USB Interface

The device can be connected to a computer using a USB cable. Once the connection is established, image and video files can be transferred from the storage card to the computer.

USB Mode:

1. Open the interface box cover and connect the USB cable to the USB Type-C interface in the connector cover. Connect the other end of the USB cable to the computer.
2. On the main menu interface, press the OK button or tap the main menu to bring up the device menu.
3. Go to **Device Menu** → **Settings** → **Device Set** → **USB Mode: AC**. The device has not yet established a connection with the computer

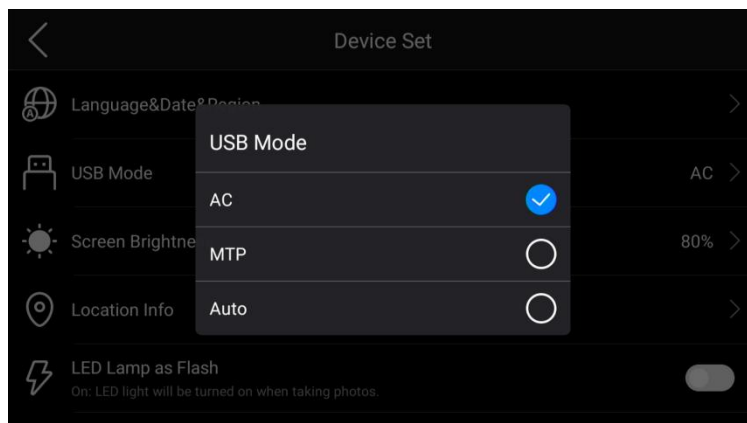

USB Mode: File Transfer (MTP)

1. Open the cover of the device interface box and connect the USB cable to the USB Type-C interface in the connector cover. Then, connect the other end of the USB cable to the computer.
2. On the main menu interface, press the OK button or tap the main menu to bring up the device menu.
3. **Device menu** → **Settings** → **Device Settings** → **USB Mode Selection: File Transfer (MTP)**, the device successfully establishes a connection with the computer.
4. On the computer, open the SD card's Gallery folder, and use drag-and-drop to move the desired files to the computer.
5. Import the images into the computer analysis software for further analysis.

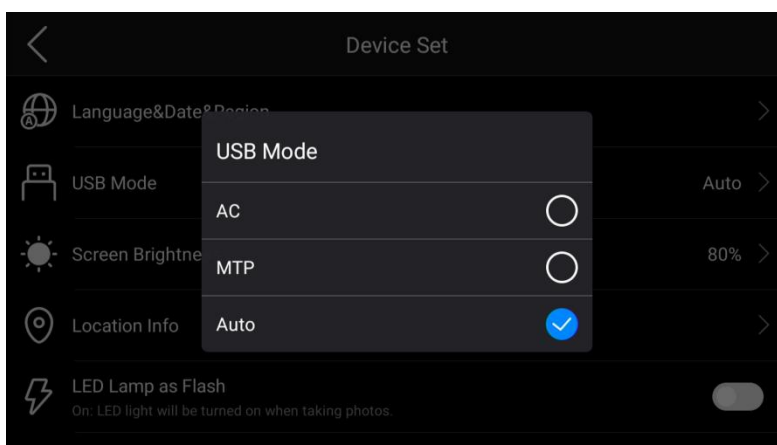

USB Mode: Auto

1. Open the cover of the device interface box and connect the USB cable to the USB Type-C interface in the connector cover. Then, connect the other end of the USB cable to the computer.
2. On the main menu interface, press the OK button or tap the main menu to bring up the device menu.
3. **Device menu** → **Settings** → **Device Set** → **USB Mode Selection: Auto**.

4. When the device is powered on, a prompt will appear: "USB cable detected. Do you want to switch to file transfer (MTP) mode?"
5. Confirm: Successfully switched to file transfer (MTP) mode, and the device successfully establishes a connection with the computer.

Cancel: Did not switch to file transfer (MTP) mode, and the device did not establish a connection with the computer.

4. HDMI Interface

Use the device-compatible HDMI cable to connect the device to the computer. The device's interface image will be synchronized and displayed on the computer screen.

5. FTP

Connect to the device via WiFi network or the device's own WiFi hotspot, then access the data on the device through FTP.

Operation steps:

1. On the main menu interface, press the OK button or tap the main menu to bring up the device menu.
2. **Device menu** → **Settings** → **Connection** → **More Connection** → **FTP** .
3. Enable FTP Quick Transfer, and use a client browser, file manager, or FTP client tool to enter the FTP address: ftp://IP:port/ to connect to the device's FTP service and perform file transfer.
4. The user can configure whether to allow anonymous access. If anonymous access is enabled, the client does not need to authenticate and can connect to the device's FTP service to operate the file system.
5. If anonymous access is disabled, the client needs to enter the configured username and password to access the file system.

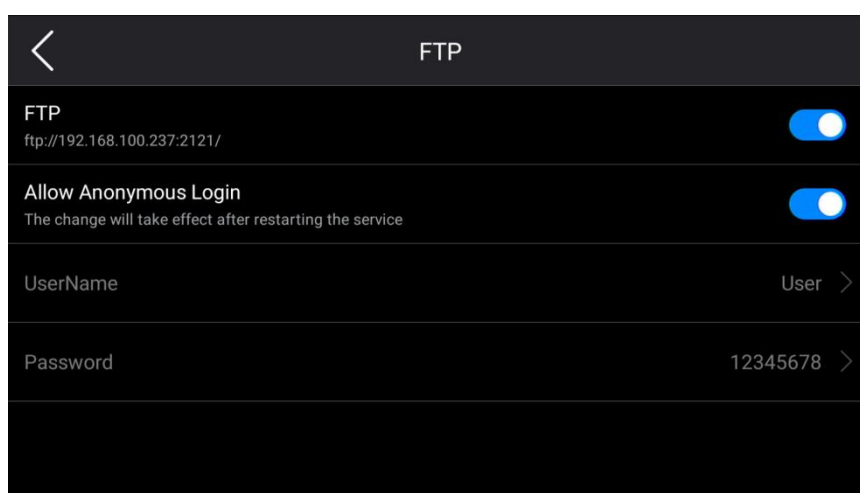

- The FTP quick transfer function on the device depends on the specific model. Please refer to the actual device for details.
- In WLAN mode, the client must connect to the same WLAN network.
- In hotspot mode, the client must first connect to the device's hotspot before it can be accessed

8. Remote Control

1. Mobile Device Control

The mobile software EasyIR is available on Android systems, allowing users to preview the device's screen, synchronize device data, and view, browse, share, and analyze the synchronized data. For detailed instructions, please refer to the user manual for the mobile app.

2. Webpage Control

Remote operation control can be performed through the browser of devices such as mobile phones, computers, and tablets, allowing you to access, analyze, and share local data. For detailed instructions on the web-based control, please refer to the user manual for the web interface.

The device's IRExplorer page displays the web link, editable username, password, and the scanned QR code.

Steps:

- Press the OK button or tap the main menu to bring up the device menu.
- **Device menu → Settings → Connections → More Connections → IRExplorer.**
- Enter the IP address on a computer or mobile device to access the IRExplorer login page.
- Log in using a username and password, or directly access the login page by scanning the QR code.



The availability of web-based control varies by model.

9. Auxiliary Functions

1. Floating Ball

The floating ball enables virtual button functions to call up features such as photo capture, lighting, AI, and gallery physical buttons.

Steps:

1. On the live interface, press the OK button or tap the main menu to bring up the device menu.
2. **Device menu → Settings → Device Set → Floating Ball.**
3. After enabling, the floating ball button will appear on the live interface and can be moved to any position.
4. Tap the floating ball button to expand the sub-functions. Tap again to collapse the sub-functions of the floating ball.

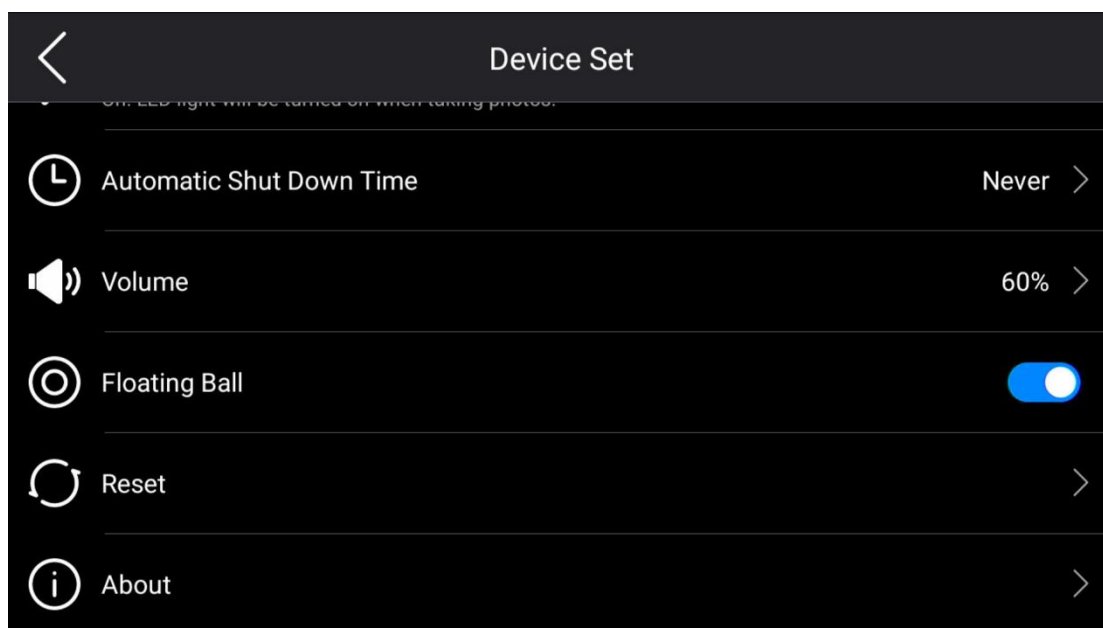

2. Ultra-to-audible Conversion

Convert inaudible ultrasonic sounds into audible sounds in real time and monitor them via Bluetooth headphones.

On the live interface, swipe down the dropdown menu and tap 'Ultra-to-audible Conversion' to enable ultrasonic listening.

On the live interface, swipe down the dropdown menu and tap 'Ultra-to-audible Conversion' to disable ultrasonic listening.

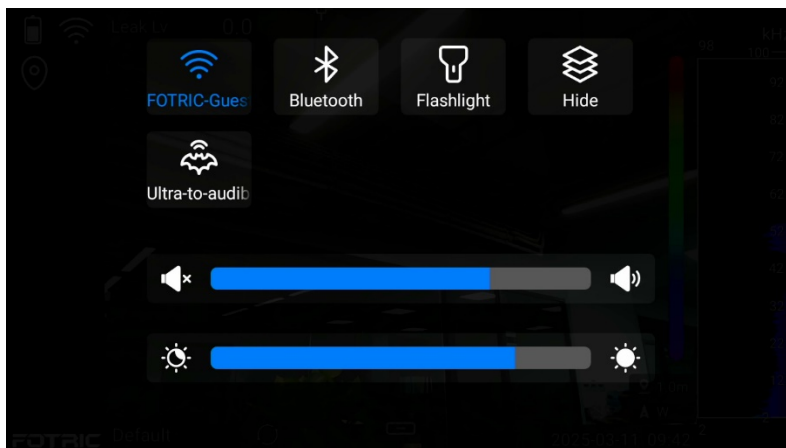

3. GPS

Supports GPS satellite positioning.

Operation Steps:

1. On the main menu interface, press the OK button/tap the main menu to bring up the device menu.
2. Device menu → Settings → Device Settings → Location Information → Geolocation.
3. Turn on Geolocation, and location information can be saved to a file.

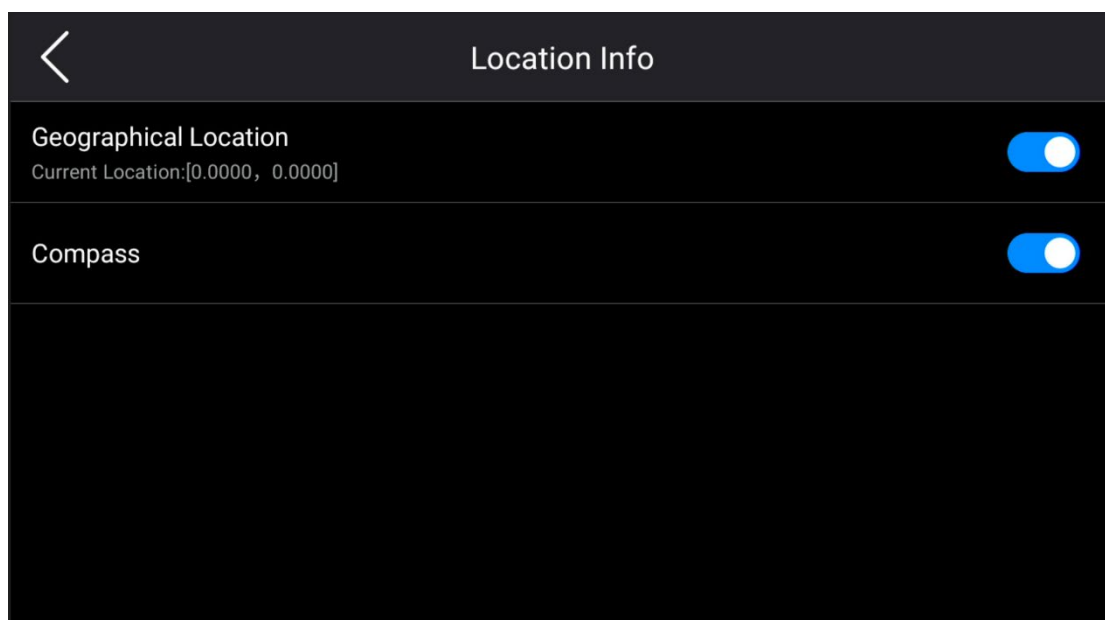

The geolocation function on the device depends on the specific model. Please refer to the actual device.

4. Compass

Support 360° orientation

Operation steps:

1. In the main menu interface, press the OK button or touch the main menu to bring up the device menu.
2. **Device menu → Settings → Device Settings → Location Information → Compass.**
3. Turn on the compass, and the orientation information can be saved to the acoustic image and radiometric video.
4. **Device menu → Settings → Acoustic image Settings → Image Overlay Information → Enable Compass.**
5. Return to the main menu interface, and the orientation information will be displayed in the image overlay section at the bottom right of the main menu interface.

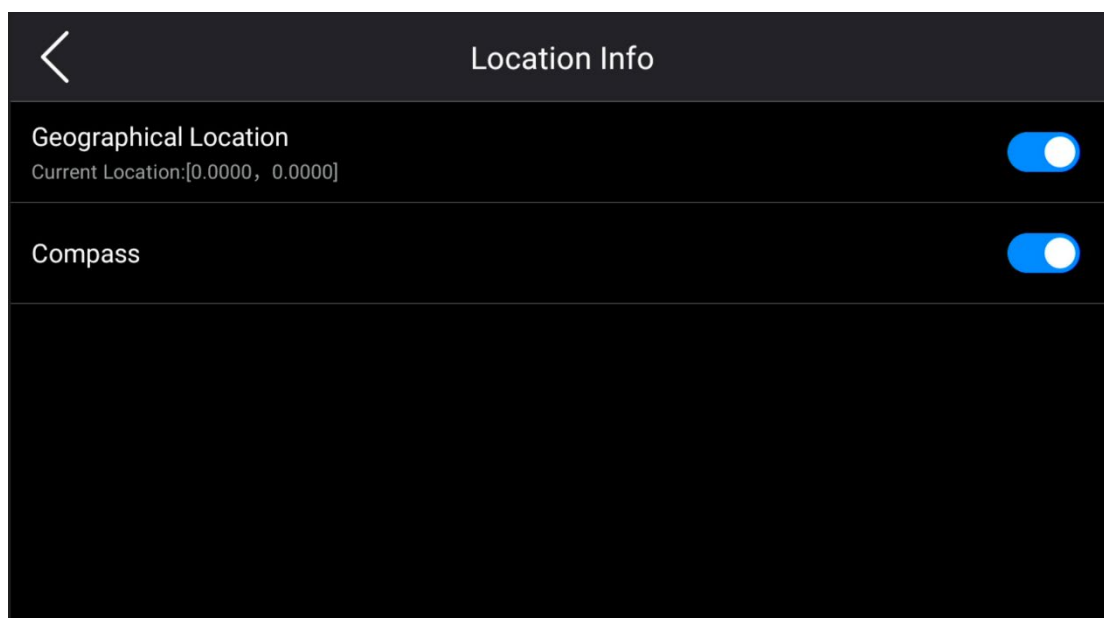

5. LED Lamp

Support for **Flashlight illumination** and **Flash mode**.

Flashlight Illumination:

Open the device's flashlight from the main menu interface drop-down menu and use it as a flashlight.

Flash Mode:

1. In the main menu interface, press the OK button or touch the main menu to bring up the device menu.
2. **Device menu → Settings → Device Settings → LED light as flash.**

- Once enabled, the LED light will function as a flash when pressing the shutter button for single-frame capture, or the LED light will continuously function as a flash during timed continuous capture for image saving.

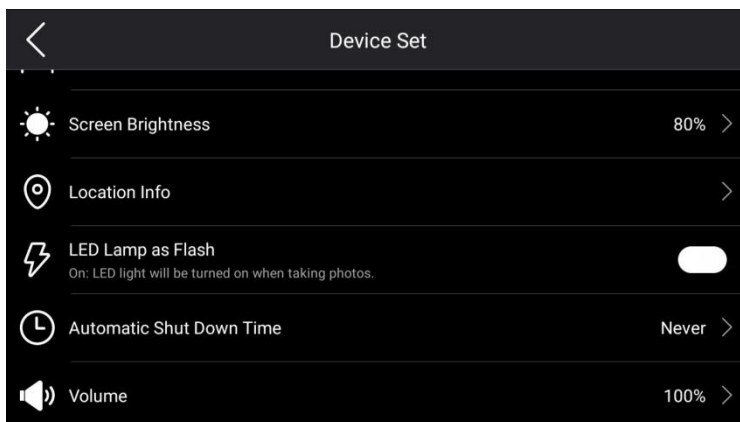

6. Language

The supported languages include: Simplified Chinese, English, Traditional Chinese, Spanish, Korean, German, Portuguese, Italian, French, and Thai.

Operation steps:

- In the main menu interface, press the OK button or touch the main menu to bring up the device menu.
- Device menu** → **Settings** → **Device Settings** → **Language&Time&Region** → **Language**.
- The default languages are Simplified Chinese and English. Select a language to switch to that language.

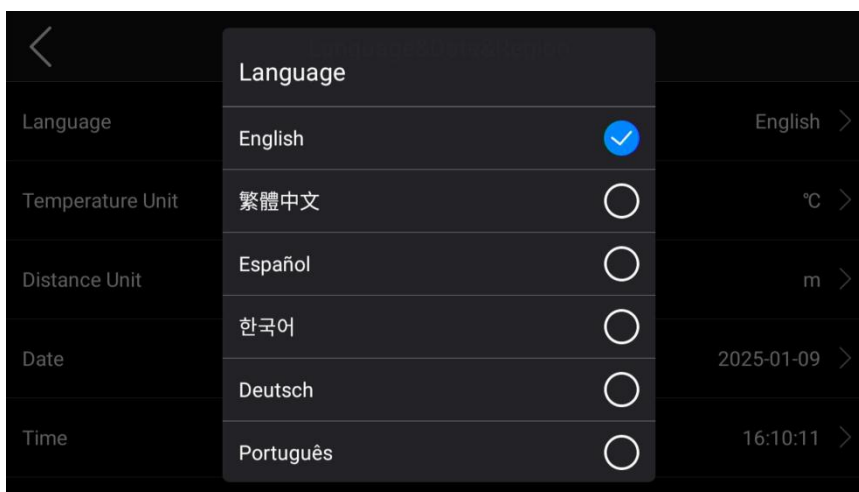

NOTE

The default language on the device depends on the specific model. Please refer to the actual

device for confirmation.

7. Software and Firmware Upgrades

Supports online software upgrades, offline upgrades, and system configuration online and offline upgrades.

Online Software Upgrade:

1. On the main menu interface, press the OK button/touch the main menu to bring up the device menu.
2. **Device Menu** → **Settings** → **Device Set** → **About** → **System Update**.
3. Ensure WIFI is enabled, the device is connected, and the network is stable.
4. Agree to the user agreement and click "Software Update."
5. Click "**Online Upgrade**," and the available upgrade version will be detected.
6. Click the upgrade button, and the system will proceed with the upgrade. After the upgrade is complete, the device will restart, and the software version will be updated to the successfully upgraded version.

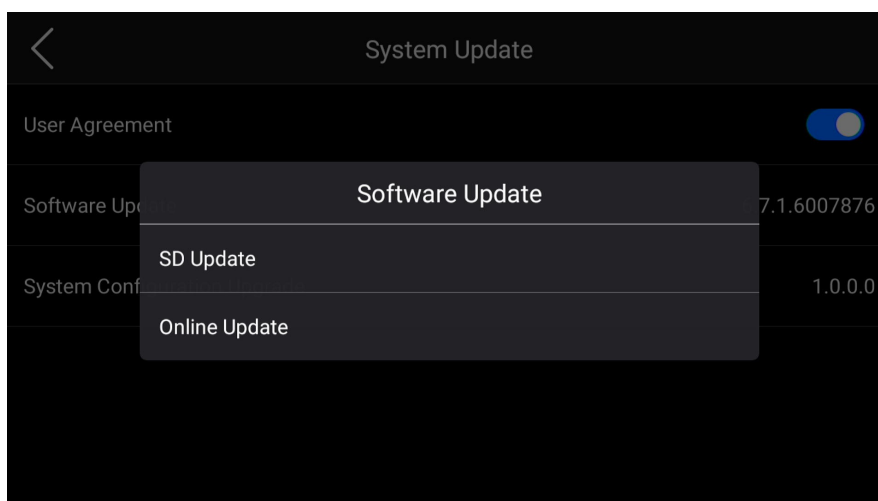

Offline Software Upgrade:

- The upgrade package (.epk file) has been placed in the device's storage card in the corresponding "update" folder.
- On the main menu interface, press the OK button/touch the main menu to bring up the device menu.
- **Device Menu** → **Settings** → **Device Set** → **About** → **System Update**
- Agree to the user agreement and click "**System update**."
- Click "**SD Update**," and a QR code scanning interface will appear.
- Use smartphone to scan the QR code. After the upgrade verification is successful, a verification code will be displayed. Enter the code in the device's QR code interface to proceed with the upgrade. Once the upgrade is completed, the device will restart, and the software version will be updated to the successfully upgraded version.

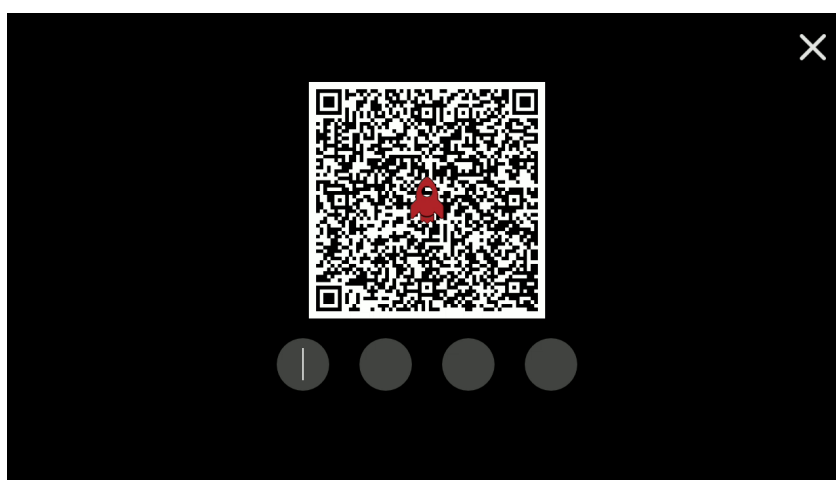

Online System Configuration Upgrade:

- Ensure WIFI is enabled, the device is connected, and the network is stable.
- On the main menu interface, press the OK button/touch the main menu to bring up the device menu.
- Device Menu → Settings → Device Set → About → System Update.
- Agree to the user agreement and click "System Configuration Upgrade."
- Click "Online Update," and the available upgrade version will be detected.
- Click the upgrade button, and the system will proceed with the upgrade. After the upgrade is complete, the device will restart, and the system configuration version will be updated to the successfully upgraded version.



Offline System Configuration Upgrade:

- The upgrade package (.epk file) has been placed in the device's storage card in the corresponding "update" folder.
- On the main menu interface, press the OK button/touch the main menu to bring up the device menu.
- Device Menu → Settings → Device Settings → Device Information → System Upgrade.
- Agree to the user agreement and click "System Configuration Upgrade."
- Click "SD Update" and a QR code scanning interface will appear.
- Use a smartphone to scan the QR code. After the upgrade verification is successful, a verification code will be displayed. Enter the code in the device's QR code interface to proceed with the upgrade. Once the upgrade is completed, the device will restart, and the device configuration version will be updated to the successfully upgraded version.

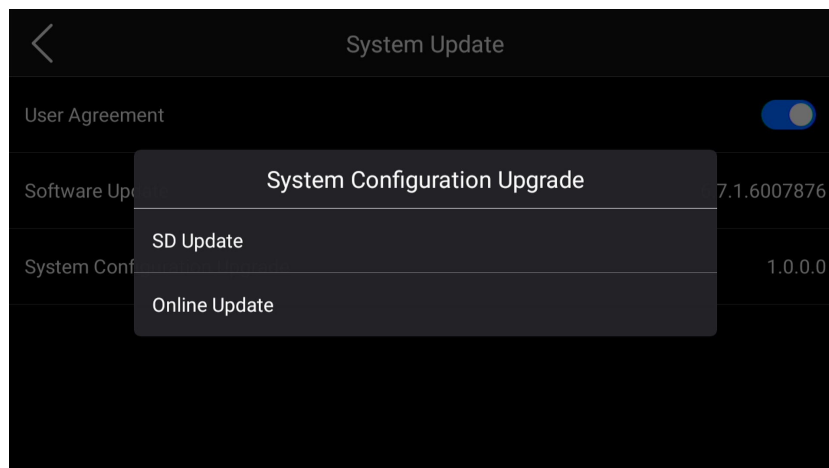

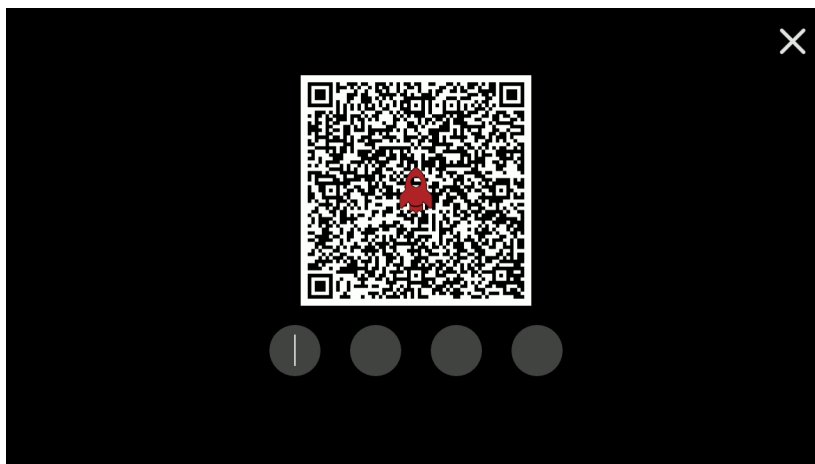

8. Device Set

Set the language, time, and region, USB mode, screen brightness, location information, LED light as flashlight, auto shutdown time, volume, reset, and view device information.

Language&Time&Region Settings: Set language, Temperature Unit, Distance Unit, Date, Time, Time Zone, and Date Format.

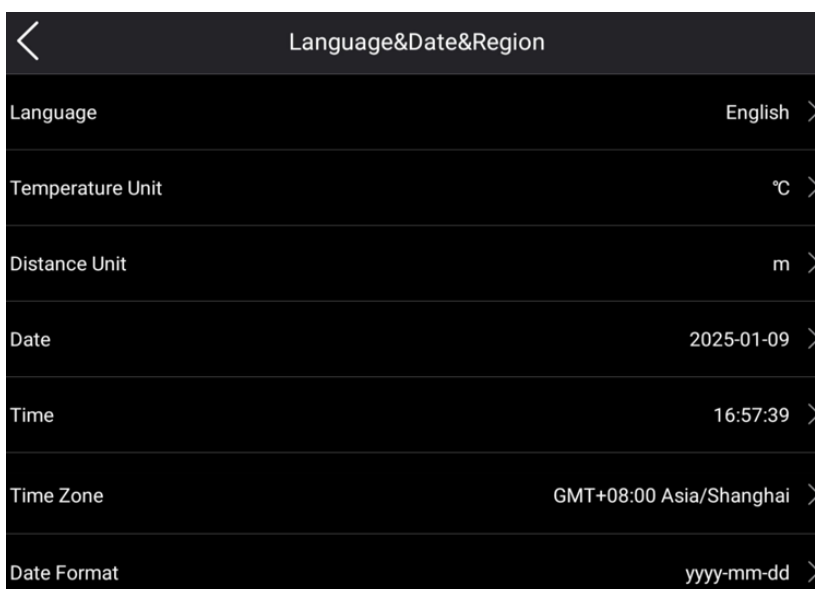

Language Setting: Refer to section 12.8 Supported Languages.

Set Temperature Unit:

1. On the main menu interface, press the OK button/touch the main menu to bring up the device menu.
2. **Device Menu** → **Settings** → **Device Set** → **Language&Time&Region** → **Temperature Unit**.
3. Set the temperature unit parameter.

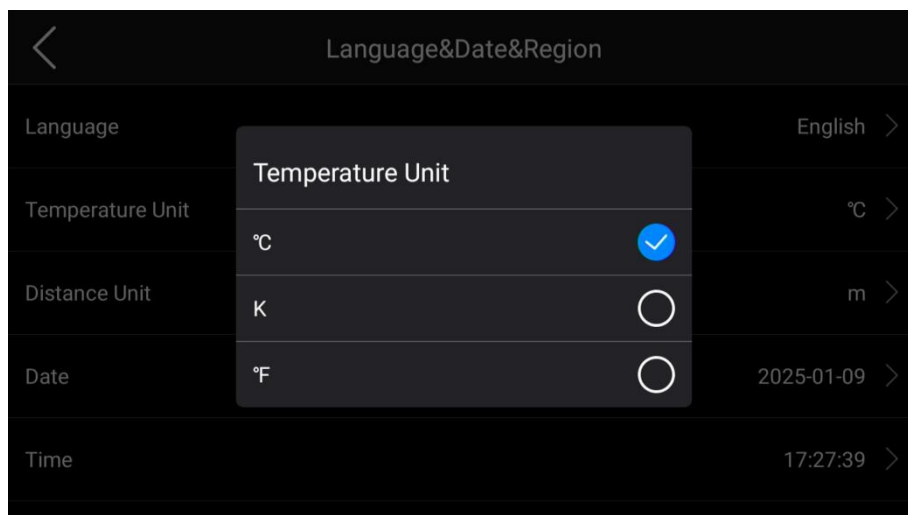

Set Distance Unit:

1. On the main menu interface, press the OK button/touch the main menu to bring up the device menu.
2. **Device Menu** → **Settings** → **Device Set** → **Language&Time&and Region** → **Distance Unit**.
3. Set the distance unit parameter.

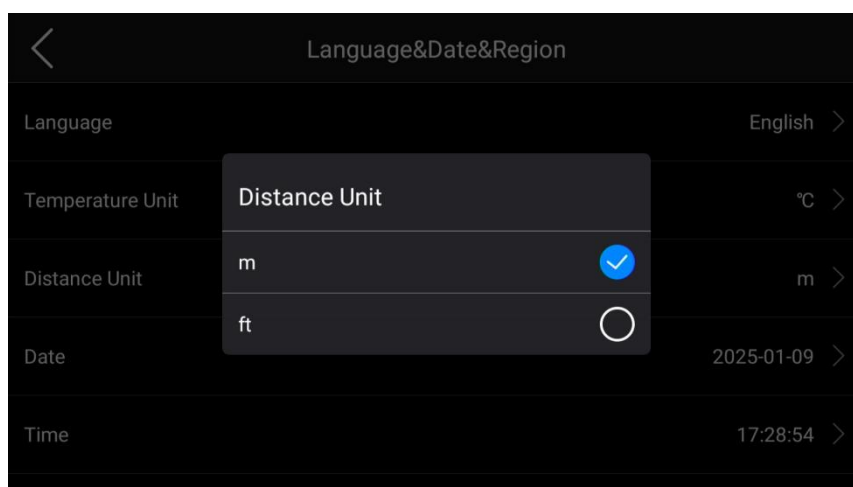

Set Date:

1. On the main menu interface, press the OK button/touch the main menu to bring up the device menu.
2. **Device Menu** → **Settings** → **Device Set** → **Language&Time&Region** → **Date**
3. Set the date parameter.

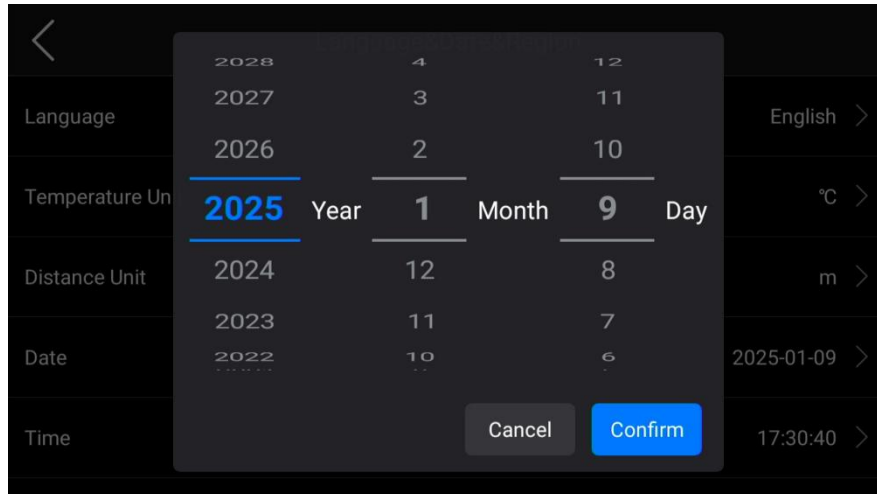

Set Time:

1. On the main menu interface, press the OK button/touch the main menu to bring up the device menu.
2. **Device Menu** → **Settings** → **Device Set** → **Language&Time&Region** → **Time**
3. Set the time parameter.

Set Time zone:

1. On the main menu interface, press the OK button/touch the main menu to bring up the device menu.
2. **Device Menu** → **Settings** → **Device Set** → **Language&Time&Region** → **Time zone**.
3. Set the time zone parameter

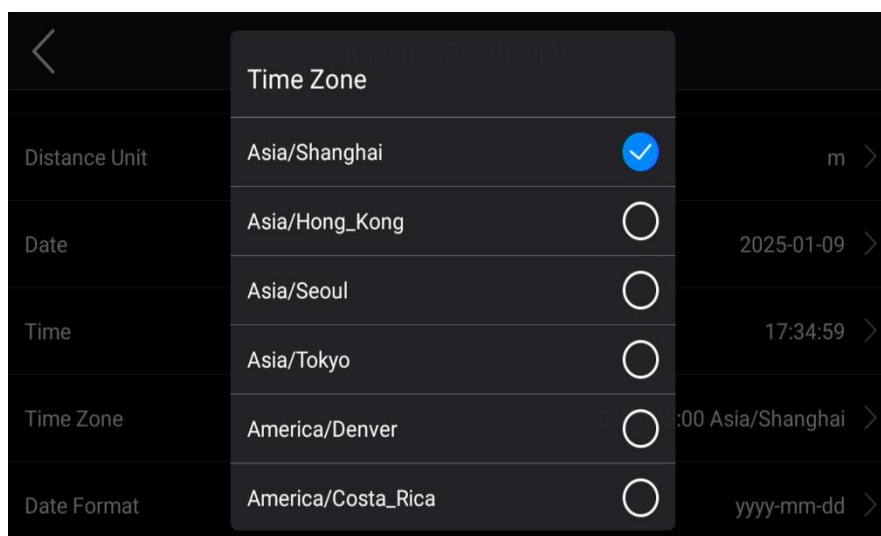

Set Date Format:

1. On the main menu interface, press the OK button/touch the main menu to bring up the device menu.
2. **Device Menu → Settings → Device Set → Language&Time&Region → Date Format.**
3. Set the date format parameter.

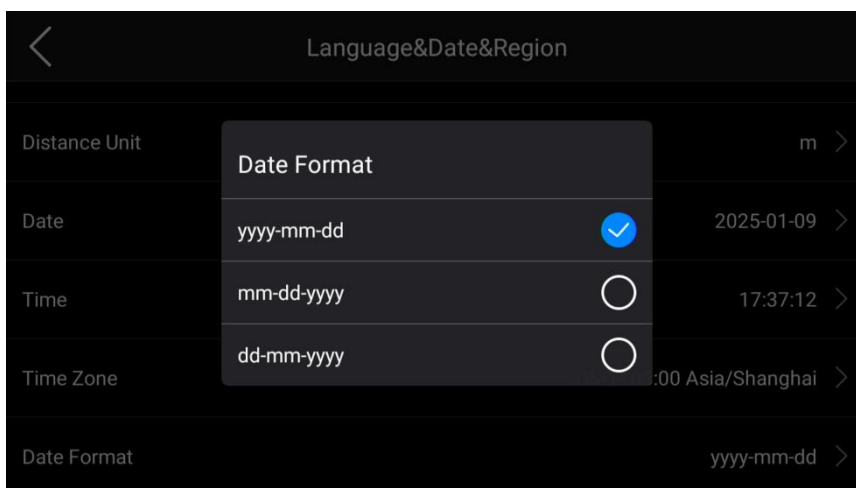

Screen Brightness:

1. On the main menu interface, press the OK button/touch the main menu to bring up the device menu.
2. **Device Menu → Settings → Device Set → Screen Brightness.**
3. Slide the screen or press the left/right buttons to adjust the screen brightness.

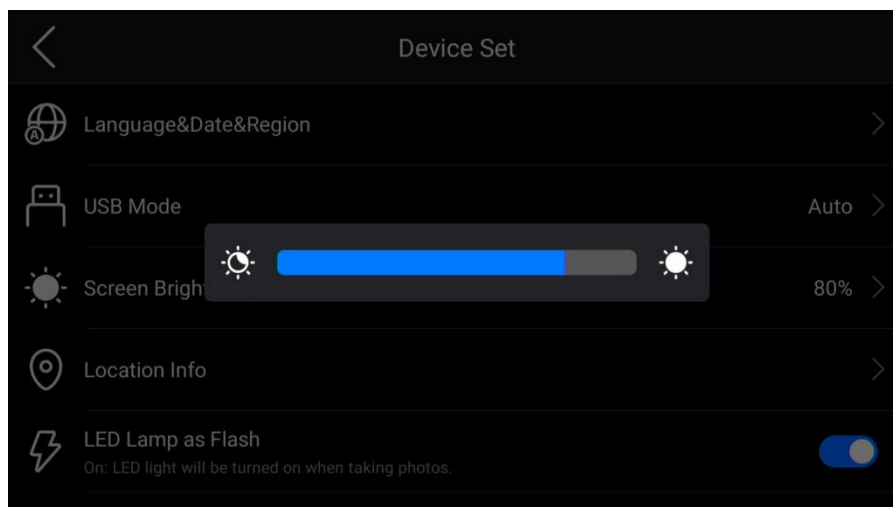

Location Information:

Refer to 13.6 Compass

LED as Flashlight:

Refer to 13.7 LED Lamp

Auto Shutdown Time:

1. On the main menu interface, press the OK button/touch the main menu to bring up the device menu.
2. **Device Menu → Settings → Device Set → Automatic Shutdown Time.**
3. Set the auto shutdown time, which specifies how long the device will stay on after inactivity before automatically shutting down.

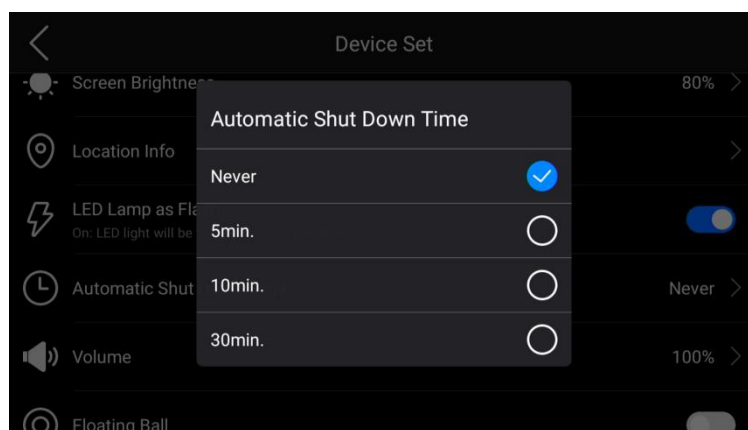
**Volume:**

1. On the main menu interface, press the OK button/touch the main menu to bring up the device menu.
2. **Device Menu → Settings → Device Set → Volume.**

Reset

Reset parameters to the factory default settings, or delete all saved files.

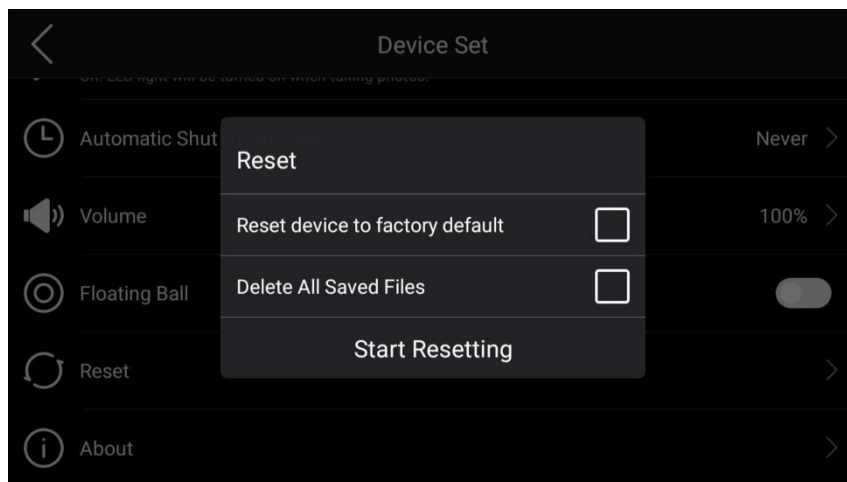

Device Information

View model, serial number, application version, system version, lens, battery level, remaining SD storage capacity, status information (IMEI, IP address, MAC address, Bluetooth address), system update.

About	
Model	Fotric P7MiX
Serial Number	1001002892
App Version	6.8.0.6008924
System Version	1.2.0.89
AC Firmware	2.9.3.7
Microphone Channels	162
Battery Level	31%
Remaining SD Card Capacity	231.51GB
Status Information	>
System Update	>

Appendix: Leak Evaluation Parameters

Name	Meaning
Leak Correction Factor	A user-defined adjustment factor applied to compensate for differences between calculated and actual leak rates. This accounts for site-specific conditions such as system pressure, leak shape, and orifice geometry.
Currency	The currency used for cost calculations. This parameter is applied to energy and gas cost values and displayed in reports.
Energy Cost	The cost of electrical energy consumed by the compressor, expressed as currency per kilowatt-hour (Currency/kWh).
Gas Cost	The cost of the leaked gas per unit volume, expressed as currency per cubic meter or cubic foot (Currency/m ³ or Currency/ft ³).
Specific Power	The amount of power required by the compressor to maintain a given flow rate. This value is typically specified on the compressor nameplate. If unavailable, it can be calculated by dividing the nominal power by the rated flow rate.
Flow Rate Unit	The unit used to express airflow measurements. Available options include liters per minute (L/min) and cubic feet per minute (CFM). This setting is used in calculations and report display.
Run Time	The total number of hours per year that the inspected pipeline or system operates. This value is used to estimate annual energy loss and cost.