

PROSENSE PPS Manager Gas Control Panel User Manual

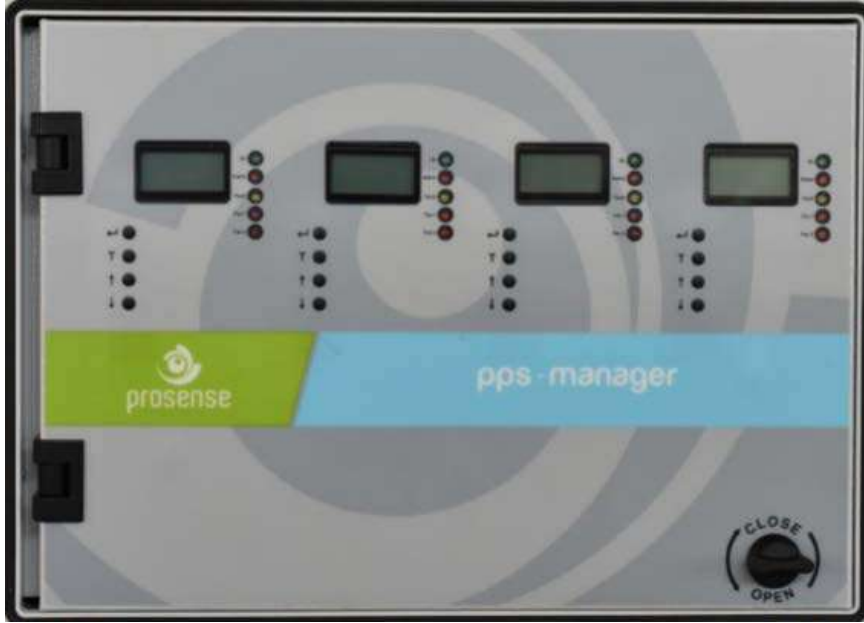

ProSense Teknoloji San. Ltd. Şti.
Cumhuriyet Mah. Mermer sok. No:16 Kartal İstanbul
Tel: (90) 216 306 77 88 Faks: (90)216 473 81 29
www.prosense.com.tr

WARNING!
READ THIS INSTRUCTION FIRST!

This manual must be carefully read by all persons who have or will have the responsibility for installing, using or servicing this product.

Like any equipment, this product will perform as designed only if installed, used and serviced in accordance with the manufacturer's instructions. Otherwise, it could fail to perform as designed and persons who rely on this product for their safety could suffer severe personal injury or death.

The warranties made by Prosense with respect to this product are voided if the product is not installed, used and serviced in accordance with the instructions in this user guide. Please protect yourself and other by following them.

WARNING!

Inductive or capacitive loads like motors, ventilation, e.g. should not be directly connected to the panel. In such cases, auxiliary external relays should be use to drive these loads.

CONTENTS

1. INTRODUCTION	4
1.1 Technical Specifications.....	4
1.2 Panel Dimensions	5
2. INSTALLATION	5
3. FUNCTIONS AND DETAILS.....	7
3.1 LCD Screen:	8
4. MAIN BOARD AND CONNECTIONS	9
4.1 Main Board Details:.....	9
4.2 Backup Battery Connection	10
4.3 Main Power Connection	11
4.4 Detector Connections.....	11
4.5 PPS Series Detectors Connections	13
4.5 Relay Outputs	15
5. FIRST RUN.....	15
5.1 Automatic Test	16
5.2 LED Test.....	16
6. PROGRAMMING	16
6.1 Set FAN1 Relay Level:	16
6.2 Set FAN2 Relay Level:	17
6.3 Set Alarm Relay Level:	18
6.4 Set Alarm Activation Type:	18
6.5 Set Gas Type:	19
6.6 Set Language:	20
6.7 Scan Detectors:	21
6.8 Show Detector:.....	21
7. ALARM STATUS.....	22
7.1 What to do in case of alarm	22
8. FAULT CODES.....	23
Declaration.....	24
Warranty Statement	25

1.INTRODUCTION

Prosense PPS Control Panel is produced specially for carparking area. Prosense PPS control Panel is able to provide automatic gas concentration reading for gases CO, NO and LPG that mostly exist on car parking areas. PPS Control Panel permanently transmits the gas concentration measurement from detectors to the control unit. Before the gas concentration in the atmosphere reaches the LEL or toxic PPM level, the control panel is able to shut off a gas valve, cut off power and turn on an alarm via activating relays.

Prosense PPS Control Panel can have up to 4 zone modules that each can monitor up to 32 detectors. A fully configured PPS Panel can handle managing 128 detectors. PPS Panel can be configured depending on detectors used in each project with one, two, three or four zone modules.

Prosense PPS Panel has three relays on each zone module those are two level fan relays (F1 and F2) and one alarm relay. Fan relays are not alarm relays. They will be activated after 60 seconds once the defined threshold level exceeded and deactivated after 240 seconds than the alarm status returned to normal. The PPS Panel has one power module that can provide power to all zone modules. This power module has also two relays which are fault and alarm. These relays will be activated if any one of the zone modules generates fault and or alarm status.

Prosense PPS Control panel can manage up to 128 addressable detectors via RS485 serial communication protocol. PPS Panel has an 2x8 LCD display to adjust measurement and alarm levels. This LCD screen and menu keys allow user to set correct properties for each detector like gas concentrations by gas type, measurement type, range and alarm levels.

1.1 Technical Specifications

Power Source	220 VAC +/-10%
Power Consumption	27 VDC/200 mA – 5.4 W max. (without connected detectors)
Inputs (Internal)	4 x 32 detectors via RS485 serial input
Relay outputs	Fan1, Fan2, Alarm for each zone Fault and Alarm for overall status
Contacts rating	3 A 24VDC
Display	Graphic LCD (2x8)
LED indicators	Fan1, Fan2, Alarm Power/ON, Fault, Alarm LEDs
Backup battery	2 x 12V 7A/h (Optional)
Operating Temp.	0-50 C ^o
Humidity	15-85% non condensing
Housing	ABS IP66 (366 X 276 X 186 mm)
Weight	5.5 kg
Main power fuse	2 A
Backup battery fuse	2 A

Table 1 : Technical specifications

1.2 Panel Dimensions

Panel dimensions are explained in Diagram 1:

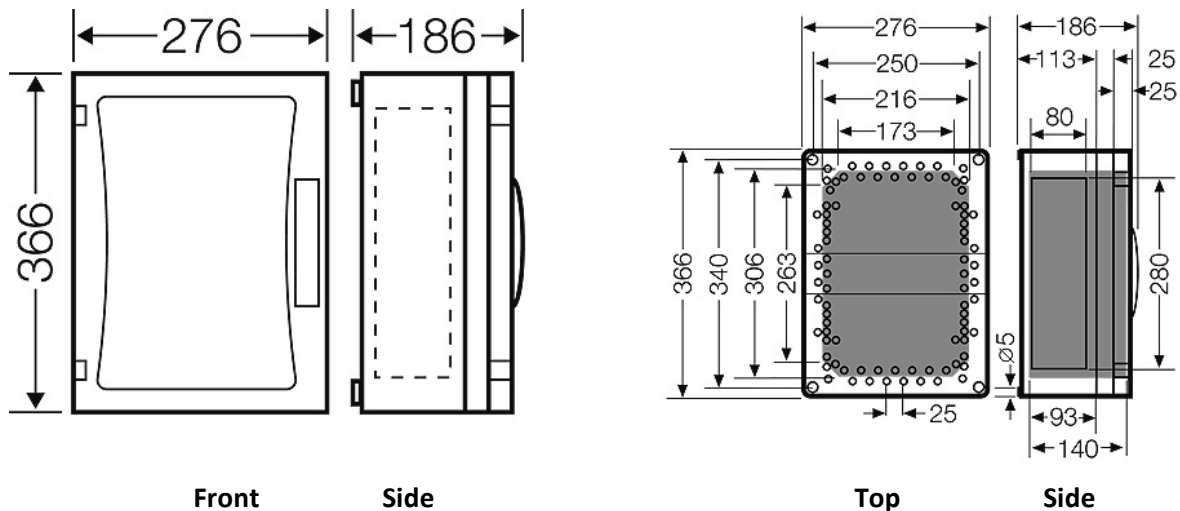

Diagram 1: Dimensions (mm)

2. INSTALLATION

The PPS Control Panel box should never be placed in an explosive atmosphere and should be readily accessible. It is necessary to drill holes for cable glands either on the top or bottom of the control unit, depending on which side the electric cables are running in. Before drilling any holes you can unscrew and remove the electronic parts to avoid accidentally damaging it. PPS Control panel should not be placed near by high voltage cables or power cable, coaxial cables or transmitters, welding stations or frequency regulators.

The PPS Control Panel box produced based on IP66 standard specifications. Always use the screw holes to mount it and do not pierce panel from any other side. Always use cable glands to make cable entries.

The PPS Control Panel has 4 plastic screws on the front of panel. Use a flat screwdriver to loose them and remove the cover part on the front. Please take care and remove the connectors on the electronic card while removing the cover. Fix the panel on the wall via using 4 screw holes after removing the front cover. Reattached the front cover and tighten 4 plastic screws when wall mounting completed.



Diagram 2: Panel cover plastic screw

To prepare cable entries, remove plastic covers from top or bottom of the panel. Then drill the holes for cable entry and install cable glands to the holes you made it. Make sure you are using an adequate IP66 rate cable gland to assure the box ingress protection is not compromised. The panel box is modular and can be used with different assemblies. Prosense recommends having cable entries from the lower side. Electronic board is located in the front cover of the panel. The power supply is located at the back of panel box. The power must be connected to this power supply. If the installation requires the connection to a backup battery, place the battery to lower right side of the panel inside.

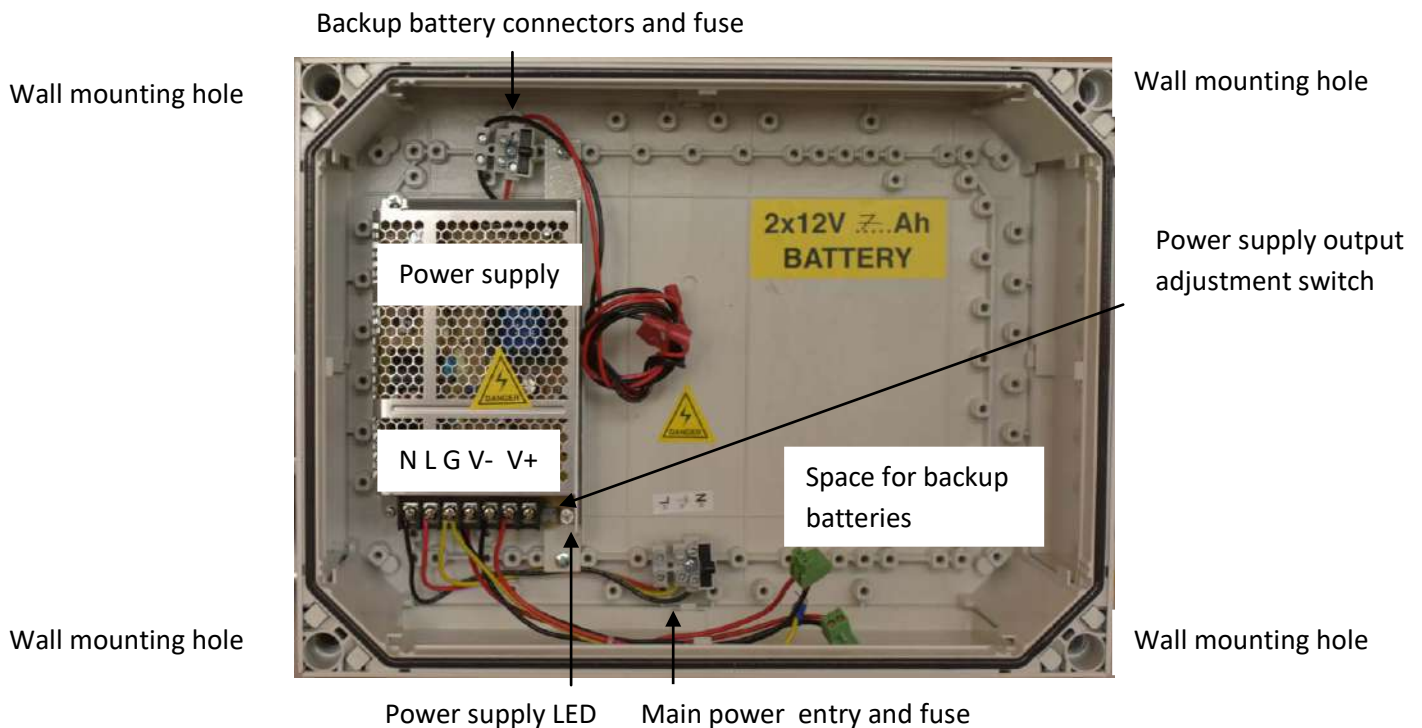

Diagram 3: Panel body

3. FUNCTIONS AND DETAILS

The front panel has the following LEDs for each zone as shown in Diagram 4:

Sign	Meaning
ON	Panel is in operation
FAN1	FAN1 relay status
FAN2	FAN2 relay status
ALARM	ALARM status
FAULT	Fault condition in at least one of the zone module

Table 2 : Front panel signs and meanings

There are four buttons near by LCD screen to perform configuration and display the detector details.

Their functions are given in table (The key assignments may vary depending on the menu page):

Key	Function For Configuration	Function For Display Operation
←	Enter to panel configuration	OK - Select key
T	Test button	Return back
↑	Go up	Go to next channel
↓	Go down	Go to next channel

Table 3 : Panel buttons and functions



Diagram 4: Front panel signs LCD and LEDs

There is a front plastic cover to protect panel from outer shells, water and dust. To reach to panel first you need to open plastic cover via pressing both sides of the latches on the front.



Diagram 5: Front cover

If panel ordered with keys a key needed to open plastic cover. In order to make panel connection, you need to open the front cover using the holder at right bottom side of front panel. The holder works clockwise and vice versa.



Diagram 6: Front cover with key



Diagram 7: Panel door holder

3.1 LCD Screen:

PPS Panel has 2x8 LCD display on each zone module to show detector address, measurement level and range as well as detector gas type.



Sign sample	Meaning
CO	Measured gas type
0	Gas level measured by detector
P	Measurement range (PPM)
D01	Detector address

Table 4 : LCD screen details

If there is no detector connected to channel, LCD screen will show fault status on channel (FLT) and fault LED will be activated. That channel should be closed (deactivated) via using menu steps.

4. MAIN BOARD AND CONNECTIONS

4.1 Main Board Details:

PPS Control panel has one power module and main power connection from power supply to control panel made on this board. This board provides power to zone modules.

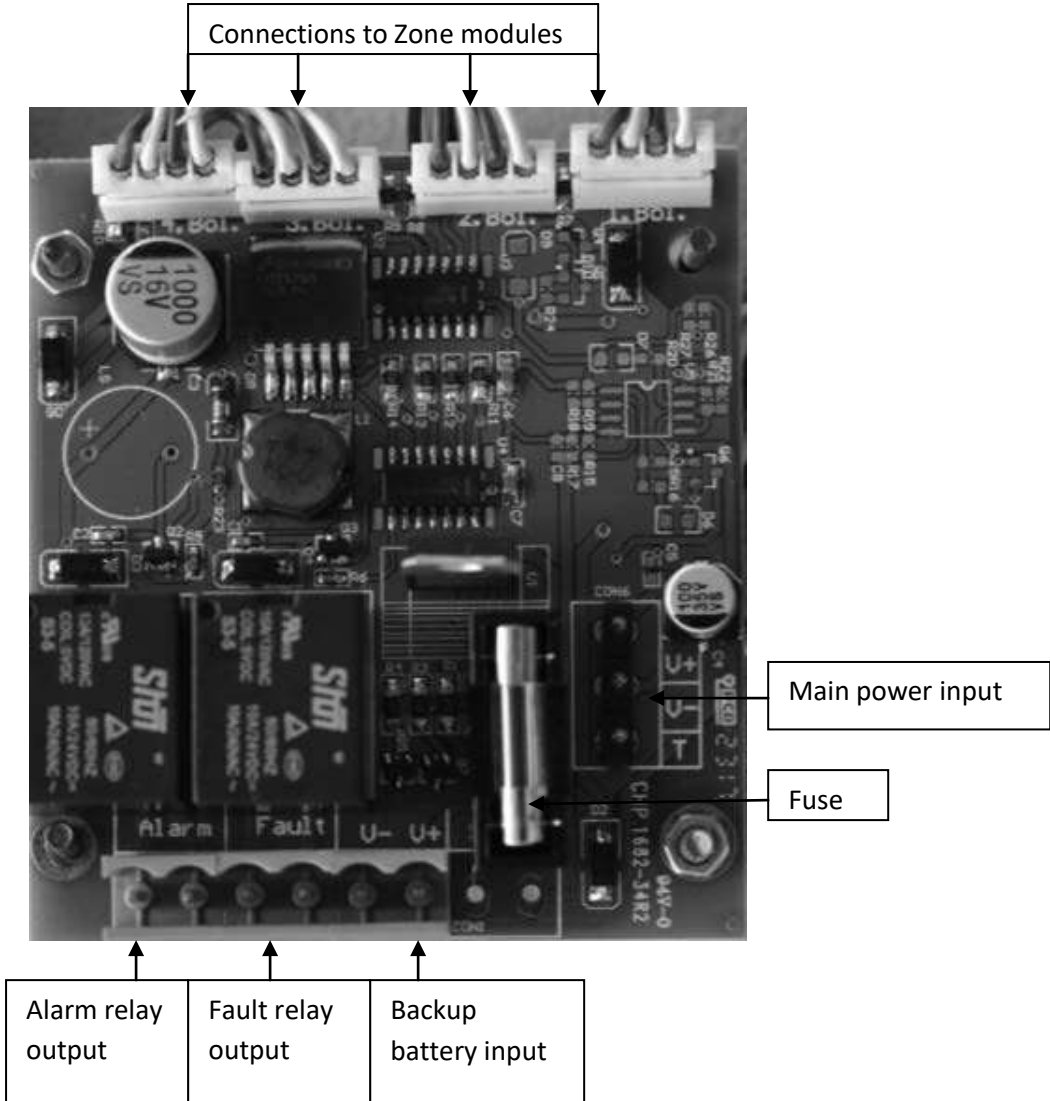

Diagram 8: Control panel main board

As shown in the picture, power module has its own fuse. Power module equipped with two relay modules as fault and alarm. Fault relay will be activated when any of the detector goes in to fault status and alarm relay will be activated when any of the zone modules raise the alarm status.

Each zone module works independantly with the detectors connected to them. The connection made by the V+, V-, A and B ports on zone module. Each zone module has three relays which are Alarm, Fan 1 and Fan 2.



Diagram 9: Control panel zone module board

4.2 Backup Battery Connection

To continue operation in case of main power failure two backup batteries (12V 7Ah) must be serially connected to the system. Take extra care to use correct poles while connecting the batteries. The cables or main board can be damaged in case of mixing pins or making short circuits. Backup batteries must be connected as shown in Diagram 10 below.

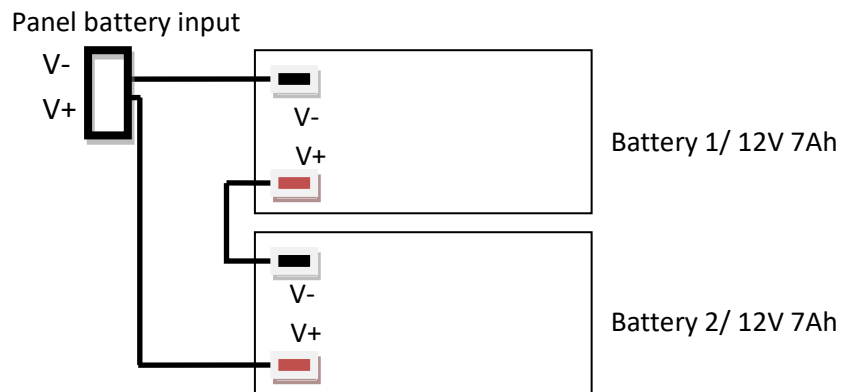

Diagram 10: Backup battery connection

4.3 Main Power Connection

Connection must be made three-wire 1.5 mm² cross section cable to the main supply terminal entries and fixed by using cable fastener on the terminal. Make sure all the detectors connected properly before applying the power.

Name	Usage
L	Phase
Gnd	Ground
N	Neutral

Table 5 : Main power connection details

4.4 Detector Connections

Each PPS panel zone module can manage up to 32 PPS series detectors via RS485 serial connection. V+, V-(GND), A and B ports must be connected via using four-wire cable. Detector connections supply 12-24VDC power to detector and read the output signal of detector from A and B ports. Thus connections should be made correctly with extra care to do not mix ports and not cause any damage on the detectors. Detector power connection should be done with 1.5mm² cross section cable. The total distance between control panel and detectors should not exceed 800m. Detector connections should be made with 4 core cable wire that 2 for power and 2 for RS485 and pin definitions are as follows:

V+	output	+24 VDC (Only for panel and detectors, do not use for any other device)
A	input	RS485 port A
B	input	RS485 port B
V-	Output	-VDC (GND)

Table 6 : Connection pin definitions

The wiring for detectors utilized with RS485 board should be done by using connection cable EIA RS485 2 core wires with section 0.22 / 0.35 mm² and shielded. Nominal capacity between the wires < 50pF/m and nominal impedance 120 Ohms.

The V+, V- ports and A,B ports are located on same socket in PPS panel zone module. These ports are formed together on Prosense PPS series detectors on detector main board. The connections should be done with care to do not mix power and RS485 ports. All detectors will be connected through one cable via hopping one detector to another till the last detector on the line.

The connection schema given in Diagram 11:

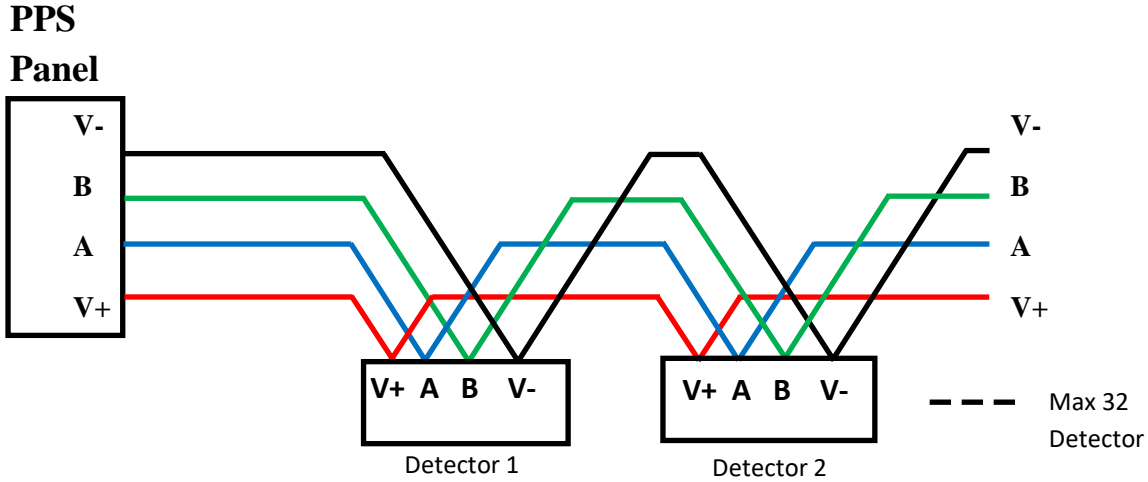

Diagram 11: Panel to detector connections

There should be one master device and up to 32 slave devices in RS485 communication. The master is DP32 control panel and detectors will be the slave devices:

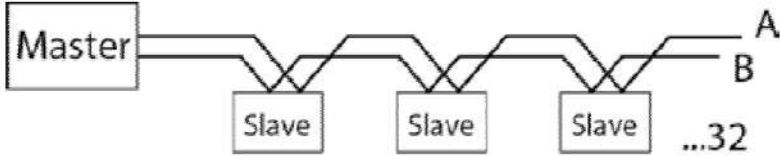

Diagram 12: RS485 communication

Each detector connected to same PPS panel should have unique address. Detectors having same address would not be recognised by control panel. PPS panel can communicate up to 32 detectors. In case less than 32 detectors connected, control panel would not show non-existent detectors. Unused detectors should be deactivated on channel settings menu steps.

The **last** detector at the RS485 serial line should have the end of line resistor to enable the total communication line. Otherwise control panel may not communicate to all, some or none of the detectors. The end of line resistor controlled by end of line pins located on Prosense PPS series detectors and can be enabled via putting the jumper on end of line pins. Details are given in section 4.5.

4.5 PPS Series Detectors Connections

Prosense PPS series detectors has onboard RS485 Modbus serial communication module. The board has 4 ports thus the detector connection should be made by 4 wire that 2 for power and 2 for RS485. The total length of the connection line should not exceed 1000 meters.

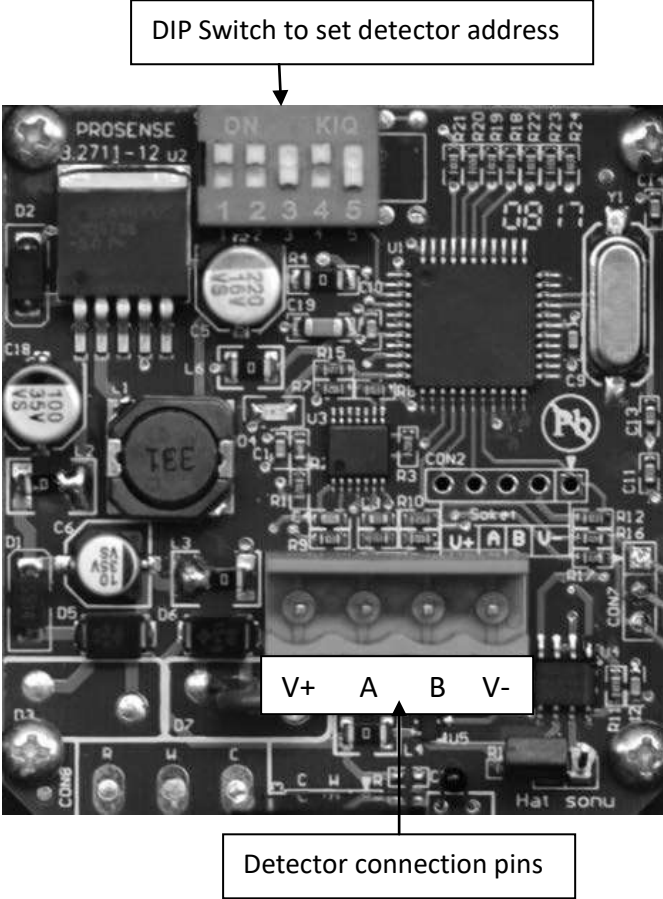

Diagram 13: PPS series detector board

The wiring for detectors utilized with RS485 board should be done by using connection cable EIA RS485 2 core wires with section 0.22 / 0.35 mm² and shielded. Nominal capacity between the wires < 50pF/m and nominal impedance 120 Ohms.

Detectors will be wired in daisy chain (bus) mode. We recommend not to use star mode connection due to negative impact of interference. Each detector should have unique address number in the chain. The detectors would not be recognised by control panel if same address given to them. The address of detector can be adjusted via using DIP-Switch set on the board:

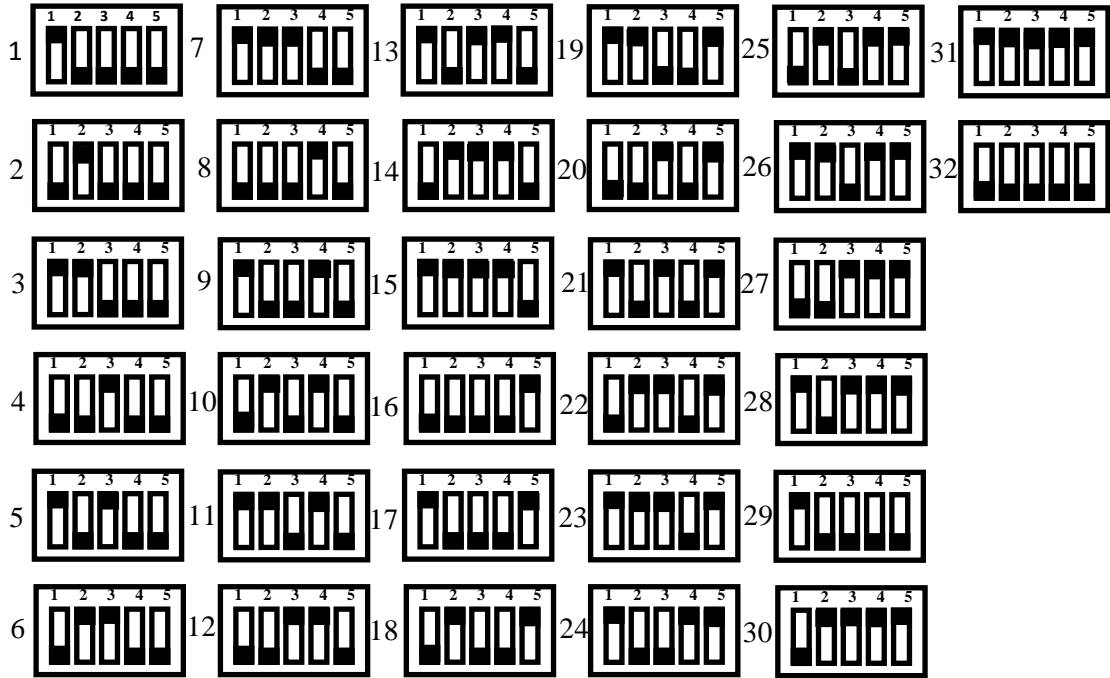
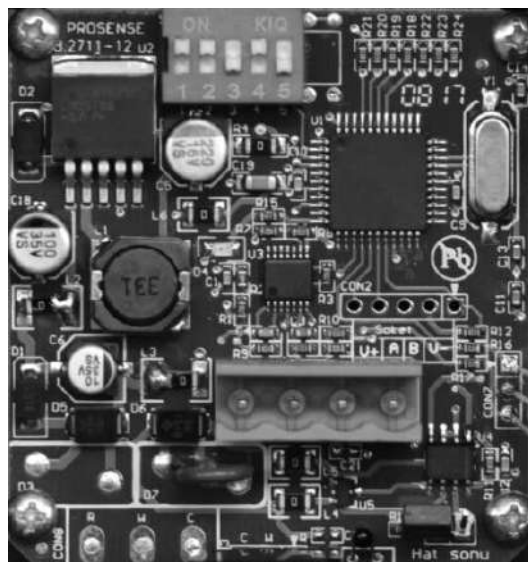

Diagram 14: RS485 Modbus serial communication address and switch position

The last detector in the chain should have 120 Ohms RS485 termination resistor. The resistor is already implemented on the board by default but not activated. User should activate the termination resistor via using the termination pin once the installation completed:



End of Line jumper enabled

Diagram 15: RS485 Modbus serial communication module end of line jumper

Important : Only the last detector on the serial bus should have end of line pin.

4.5 Relay Outputs

PPS panel has two relays which are fault and alarm on main power module.

Fault: This relay will be activated when any of the zone modules in the system raise fault status.

Alarm: This relay will be activated when any of the zone modules in the system will exceed the programmed alarm level.

Each zone module has three relays which are Alarm, Fan1 and Fan2. Their activation mechanism as follows:

Alarm: This relay will be activated when the defined gaz level threshold exceed depending of the activity type defined for related zone.

Fan 1: This relay will be activated after 30 seconds when any of the detectors will exceed the programmed F1 level in related zone. This relay will be deactivated after 240 seconds when the status returned to normal.

Fan 2: This relay will be activated after 30 seconds when any of the detectors will exceed the programmed F2 level in related zone. This relay will be deactivated after 240 seconds when the status returned to normal.

The relays are configured as NO (Normally Open) by default at factory. The relay configurations cannot be adjusted to NC (Normally Closed)

Important: Relays should not be connected to high current or 220 VAC loads. The relay outputs should be used as control signal and external relays should be used to drive such devices as relay on main board cannot handle high load.

5. FIRST RUN

After power applied to PPS panel it will start illuminating the On LED. The LCD display show "Scanning Detector" at same time while panel tries to initialize the detectors connected to it:

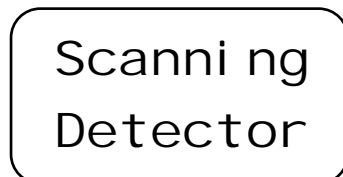

Scanning
Detector

Scanning will take at least 2 minutes. After two minutes each zone module installed on the PPS panel will report the number of detectors they recognized:

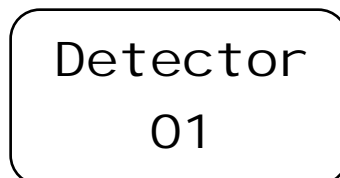

Detector
01

If all detectors working fine then LCD display will show the status of detectors: at first line the number of detectors and average gas measurement level, at the bottom the detector address which is measuring the highest gas level and the measurement level.

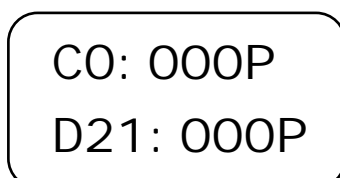

CO: 000P
D21: 000P

In case an error the fault LED will be activated together with fault relay at same time. Fault details can be seen via pressing up and down buttons. The fault codes and details given in section 8.

5.1 Automatic Test

Prosense PPS Manager simultaneously monitor all detectors connected to it. The FAULT relay and LED will be activated in case any problem. Alarm and fault status can be monitored on the screen.

5.2 LED Test

Prosense PPS Manager has special function to test LEDs on front panel at any time. Press T button to initiate test operation. Panel will activate all LEDs for moment and turn off all of them except on LED as it is always blinking.

6. PROGRAMMING

The panel is already programmed and ready for using when shipped. User should adjust the gas type, alarm settings for each detector. Each detector should be defined independently. These adjustments can be done via using the keys near by LCD screen. The menu content includes below items:

Menu Item	Function
Set Ext1	Set fan1 relay alarm level
Set Ext2	Set fan2 relay alarm level
Set Alrm	Set alarm level
Actv Typ	Set alarm raising method
Gas Type	Set gas type of the detector
Language	Set Language
Scan Det	Start scanning detectors
Show Det	Show each detector status

Table 7: Menu structer

6.1 Set FAN1 Relay Level:

To set alarm level for FAN1 press menu button to see menu items. The first item on menu is Set Ext1 to set level for FAN1:



Press menu button again to start adjustment. It will ask the gas type :

Sel Gas
CO

Gas type can be changed via pressing up and down arrow buttons. There are three gas type supported by PPS Manager which are CO, NO2, LPG. Once decided press Menu button to continue. It will show the current level:

Ext1 Lv:
040

Alarm level can be increased or decreased via pressing up and down arrow buttons. For CO gas levels will increase or decrease by steps 10PPM while for NO2 1PPM and for LPG 1LEL steps. Once the level set use T button to return back to main menu or press again to exit from menu. FAN1 level cannot be adjusted higher than the FAN2 relay level or Alarm relay alarm level. Thus user should adjust first the FAN2 level or Alarm level.

6.2 Set FAN2 Relay Level:

To set alarm level for FAN2 press menu button to see menu items. The second item on menu is "Set Ext2 " to set level for FAN2. Thus up and down arrow buttons should be used to reach to "Set Ext2 " menu item:

Set Ext2

Press menu button again to start adjustment. It will ask the gas type :

Sel Gas
CO

Gas type can be changed via pressing up and down arrow buttons. There are three gas type supported by PPS Manager which are CO, NO2, LPG. Once decided press Menu button to continue. It will show the current level:

Ext2 Lv:
100

Alarm level can be increased or decreased via pressing up and down arrow buttons. For CO gas levels will increase or decrease by steps 10PPM while for NO2 1PPM and for LPG 1LEL steps. Once the level set use T button to return back to main menu or press again to exit from menu. FAN2 level cannot be adjuster higher than the Alarm relay level. Thus user should adjust first the Alarm level.

6.3 Set Alarm Relay Level:

To set alarm level for FAN2 press menu button to see menu items. The third item on menu is “Set Alrm “ to set level for Alarm relay. Change the menu item via up and down arrow buttons to reach “Set Alrm “ menu item:

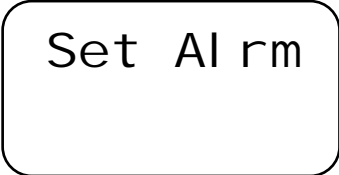

Press menu button again to start adjustment. It will ask the gas type :



Gas type can be changed via pressing up and down arrow buttons. There are three gas type supported by PPS Manager which are CO, NO2, LPG. Once decided press Menu button to continue. It will show the current level:

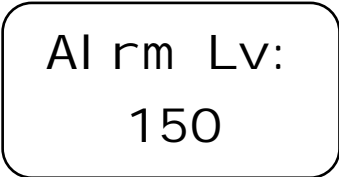

Alarm level can be increased or decreased via pressing up and down arrow buttons. For CO gas levels will increase or decrease by steps 10PPM while for NO2 1PPM and for LPG 1LEL steps. Once the level set use T button to return back to main menu or press again to exit from menu.

6.4 Set Alarm Activation Type:

PPS Manager can activate relay in two mode. Either it can use each detectors gas measurement level independently and activate alarms when any one of the detectors reached the adjusted level or it can collect each gas detectors gas measurement level and calculate average gas measurement level at the time of the reading to activate alarms. To set alarm activation type press menu button to see menu items. The fifth item on menu is “Actv Typ“ to adjust alarm activation method. Change the menu item via up and down arrow buttons to reach “Actv Typ“ menu item:



Press menu button again to start adjustment. It will show default method :

Al m Typ
Avrg Val

Activation method can be changed via up and down arrow buttons:

Al m Typ
Max Val

Once decided use T button to return back to main menu or press again to exit from menu.

6.5 Set Gas Type:

PPS Manager can work together simultaneously three different gas type which are CO, NO2 and LPG. Although PPS Manager can automatically recognize the connected detectors, it asks user to confirm gas type. The reason is to make sure whether user connected the detector by mistake or real usage as different gas types have different behaviours. To set gas type of the detector press menu button. The sixth item on menu is "Gas Type" to set gas type of the detector. Change the menu item via up and down arrow buttons to reach "Gas Type" menu item:

Gas Type

Press menu button again to start adjustment. It will show each gas type by order:

CO
Yes

If the gas type is incorrect change the answer from "Yes" to No" via using up and down arrow buttons:

CO
No

Once confirmed use T button to return back to main menu. If you the gas type is not the gas shown on the menu, change the gas type via pressing to menu button.

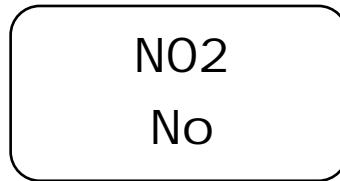

Then press again to see other option:

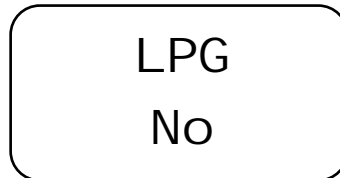

The fault LED will be activated in case user given “Yes” answer for two different gas type as detectors in this series can measure only one type of gas. Once gas type set use T button to return back to main menu or press again to exit from menu.

6.6 Set Language:

PPS Manager currently supports two languages which are English and Turkish. User can change the language via seventh menu item “Language”. Press menu button and use up and down arrow buttons to reach “Language” menu item:

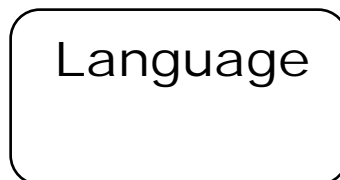

Press menu button again to start adjustment. It will show current language on screen:

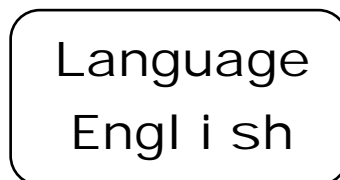

To change Language use up and down arrow buttons:

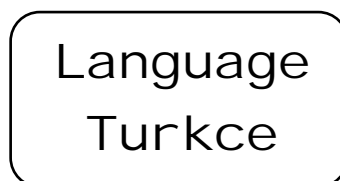

Once confirmed use T button to return back to main menu.

6.7 Scan Detectors:

In case any detectors added, replaced or changed on PPS Manager, Scanning should be initiate to allow panel recognize the detectors. This can be done via eight item on the menu. Press menu button and use up and down arrow buttons to reach "Scan Det" menu item:



Press menu button again to start scanning. It will request confirmation again:



press menu button again to start scan operation.

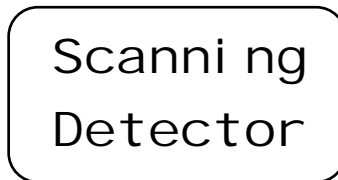

It will take at least two minutes to complete scan operation. The screen will show number of detectors when scan operation completed:

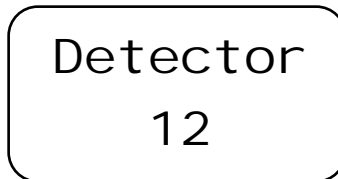

Press T button to return back to main menu. Menu will return to display mode if user not take any action for a minute.

6.8 Show Detector:

Show detector menu item shows each detectors status in detail. Press menu button and use up and down arrow buttons to reach last menu item "Show Det" menu item:



Press menu button again to see detectors one by one. It will show detector number, measured gas type and current gas measurement level on screen:

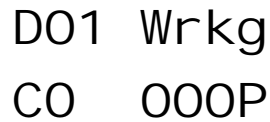

D01 Wrkg
CO 000P

Press up and down arrow buttons to see other detectors. If the detector is not installed screen will show not installed status with detector number:

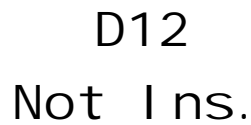

D12
Not Ins.

Press T button to return back to main menu. Menu will return to display mode if user not take any action for a minute.

7. ALARM STATUS

There are 4 independent LEDs for each zone module as fault, alarm, fan1 and fan2. Depending of the alarm activation type PPS Manager activate Fan1, Fan2 or Alarm relays and activate related LEDs on the front panel. As it is designed to work for parking areas, fan1 will be activated to start ventilation when average or any one of the detectors gas reading reaches the defined level. Then if gas measurement still increasing the Fan2 relay will be activated. Finally if the measured gas level reaches the alarm level the alarm relay will be activated.

In addition to these zone module relays there are one fault and one alarm relay on main pozer control board to monitor overall status. The fault relay will be activated any one of the zone module raises a fault condition. Same as fault, alarm relay will be activated any one of the zone module raises an alarm condition. The LEDs and related relay outputs will be active untill detector change the alarm status.

7.1 What to do in case of alarm

Refer to the mandatory safety procedures (gas alarm) set forth by your safety manager.

Recommendations:

Keep calm and follow these instructions:

1. Put out all naked flames (including cigarettes, pipes, etc.)
2. Turn off all gas appliances.
3. Turn off the gas supply at the tap and/or on the gas bottle (in the case of LPG).
4. Do not switch electrical appliances, lamps or the gas detection control unit on or off.
5. Open all windows and doors to air the room.
6. Do not "reset" the control unit if it is in the same room.

If the gas concentration reading on the control unit does not fall below the level of alarm, and the reason for the gas leak is not immediately apparent and/or cannot be repaired, quit the premises and call the gas supplier and/or emergency services immediately to check the installations and to make the premises safe and to possibly carry out the necessary repairs.

If the alarm stops and the reason for the alarm is identified and resolved (e.g. a kitchen burner lit off but in the open position) the gas supply may be re-opened after checking that all the gas appliances are off.

8. FAULT CODES

PPS panel will display the fault code when an fault condition detected. Press up and down arrow buttons to see fault codes while fault status raised and fault LED activated:



Here the code details that can help to understand problem and find a resolution:

Fault Code	Details
10	EFuse Detector Power Line Fault
11	No detector installed on zone module
12	Detector in fault status. Either detector raising a fault status or communication to detector interrupted
13	CO gas selected for detectors but there is no CO detector installed on zone module
14	NO2 gas selected for detectors but there is no NO2 detector installed on zone module
15	LPG gas selected for detectors but there is no LPG detector installed on zone module

Table 8. Fault codes and details

Declaration



Manufacturer Declaration of Conformity



Prosense Teknoloji San Ltd. Şti declares the PPS Manager Series products to be in accordance with the following standards and directives.

Name and address of Manufacturer: **Prosense Teknoloji San Ltd Şti**
Cumhuriyet Mah, Mermer Sk. No:16
34876 Kartal – İstanbul – Türkiye

Description of Devices: PPS Manager Series Fixed Type Gas Control Panel

Applied Harmonized international standards:

EN 50270:2015 Electromagnetic compatibility - Electrical apparatus for the detection and measurement of combustible gases, toxic gases and oxygen

Applied European Directives:

2014 / 30 / EU Electromagnetic Compatibility (EMC)
2014 / 35 / EU Low Voltage (LVD)

Each PPS Manager Series gas control panel device which Production Quality Assurance procedures and Type Examination procedures have been applied has been shown to conform to an approved Type and to the applicable classification rules and essential principles before being supplied. This declaration is being made on the basis of the following certificates:

Production Quality Assurance Certificate: ExVeritas 18PQAN0072

Authorised Signatory: **Firat Celep**
Production Manager

Date: **06.02.2020**

Warranty Statement

All products are designed and manufactured to the latest internationally recognized standards by Prosense Technology under a Quality Management system that is certified to ISO 9001. As such Prosense Technology warrants its products against defective parts and workmanship and will repair or (at its option) replace any instruments which are or may become defective under proper use within 12 months from date of commissioning by an approved Prosense Technology representative or 18 months from date of shipment from Prosense Technology, whichever is the sooner. This warranty does not cover disposable batteries or damage caused by accident, abuse, abnormal operating conditions or poisoning of sensor.

Defective goods must be returned to Prosense Technology premises accompanied by a detailed description of any issue. Where return of goods is not practicable Prosense Technology reserves the right to charge for any site attendance where any fault is not found with the equipment. Prosense Technology shall not be liable for any loss or damage whatsoever or howsoever occasioned which may be a direct or indirect result of the use or operation of the Contract Goods by the Buyer or any Party.

This warranty covers instrument and parts sold to the Buyer only by authorized distributors, dealers and representatives as appointed by Prosense Technology. The warranties set out in this clause are not pro rata, i.e. the initial warranty period is not extended by virtue of any works carried out there under.

In no event will Prosense Technology be liable for any incidental damages, consequential damages, special damages, punitive damages, statutory damages, indirect damages, loss of profits, loss of revenues, or loss of use, even if informed of the possibility of such damages. Prosense Technology's liability for any claims arising out of or related to this product will in no case exceed the order value. To the extent permitted by applicable law, these limitations and exclusions will apply regardless of whether liability arises from breach of contract, warranty, tort (including but not limited to negligence), by operation of law, or otherwise.